



GIMA

Bluetooth® Blood Glucose Monitoring System

User's Manual



Manufacturer



ACON Laboratories, Inc.
5850 Oberlin Drive, #340
San Diego, CA 92121, USA

EC REP

MDSS GmbH
Schiffgraben 41
30175 Hannover, Germany

Number: 1151321001
Effective Date: xxxx-xx-xx

IVD

CE 0123

Attention: By approving the enclosed design draft, you (ACON's Customer) accept all responsibility for the accuracy of the design. If an error is detected following the printing or manufacturing of a material, you (ACON's Customer) are responsible for the cost of any inventory which is deemed unsuitable for sale.

PANTONE 485 C



US

OUS

DOMESTIC

OTHER

Description GIMA OC Sure Sync upgrade CE User's Manual (En) **Part Number** 1151321001 **Size** 165x110mm

Printing Contents / **L Number** / **Size** /

Designer nafei.chen **Design Date/Version** Mar 17, 2021 / A

Artwork checked by **Material** 封面157g双铜+水性上光, 内页70g双胶 **Checked by**

Approved by Customer **Approved by Marketing/Sales**

Approved by P.M.T. **Approved by QA** **Effective Date**



***Bluetooth*[®] Blood Glucose Monitoring System**

Self monitoring of blood glucose (SMBG) is an integral part of diabetes care, but the high cost of testing can make this impossible. At **GIMA**, our goal is to provide high quality glucose monitoring at a price that allows you to test as often as necessary. Together, we can better manage your diabetes and help you live a longer and healthier life.

Welcome, and thank you for choosing the *GIMA Bluetooth*[®] Blood Glucose Monitoring System. The *GIMA Bluetooth*[®] Blood Glucose Monitoring System will give you accurate blood glucose results from Capillary, Arterial, Venous and Neonatal blood samples in just a few simple steps. *GIMA Bluetooth*[®] may be used by people with diabetes at home and by healthcare professionals for the quantitative measurement of glucose in capillary whole blood from the finger, forearm, and palm. Only professionals may also test neonatal, arterial and venous blood samples.

To ensure accurate results from your *GIMA Bluetooth*[®] Blood Glucose Monitoring System, please follow these guidelines:

- Read instructions before use.
- Use only *GIMA* Blood Glucose Test Strips with the *GIMA Bluetooth*[®] Blood Glucose Meter.
- For *in vitro* diagnostic use only. Your blood glucose monitoring system is to be used only outside the body for monitoring the effectiveness of diabetes control. It should not be used for the diagnosis of diabetes.
- For self testing and professional use.
- Test only whole blood samples with the *GIMA Bluetooth*[®] Blood Glucose Test Strips and Meter.
- For self-testers, consult your physician or diabetes healthcare professional before making any adjustments to your medication, diet or activity routines.
- Keep out of reach of children.

By following the instructions outlined in this User's Manual, you will be able to use your *GIMA Bluetooth*[®] Blood Glucose Monitoring System to monitor your blood glucose and better manage your diabetes.

Table of Contents

| | |
|--|-----------|
| Getting Started | 1 |
| Component Descriptions | 2 |
| <i>GIMA Bluetooth</i> [®] Blood Glucose Meter | 3 |
| Meter Display | 5 |
| <i>GIMA</i> Blood Glucose Test Strips | 7 |
| <i>GIMA</i> Glucose Control Solution | 9 |
| Installing the Battery | 11 |
| Meter Setup Before Testing | 12 |
| Device Pairing | 19 |
| Performing a Quality Control Test | 21 |
| Testing Your Blood | 25 |
| Step 1 – Getting a Drop of Blood..... | 25 |
| Step 2 – Testing Blood Glucose | 30 |
| “HI” and “LO” Messages..... | 34 |
| “Hypo” and “Hyper” Messages | 34 |
| “Ketone” Message..... | 35 |
| Using the Meter Memory | 36 |
| Viewing Stored Records | 36 |
| Clearing the Memory..... | 38 |
| Data Transfer Using Data Cable..... | 38 |
| Manually Transfer Records via <i>Bluetooth</i> [®] wireless technology | 40 |
| Maintenance | 42 |
| Replacing the Battery..... | 42 |
| Caring for Your <i>GIMA Bluetooth</i> [®] Blood Glucose Monitoring System | 43 |
| Suggested Testing Times and Target Goals | 44 |
| Comparing Meter and Laboratory Results | 45 |
| Troubleshooting Guide | 46 |
| Specifications | 48 |
| Warranty | 49 |
| Index of Symbols | 50 |
| Index | 51 |

Getting Started

Before testing, read the instructions carefully and learn about all the components of your *GIMA Bluetooth*[®] Blood Glucose Monitoring System. Depending on the *GIMA Bluetooth*[®] product you purchased, some of the components may need to be purchased separately. Please check the list of contents on the outer box for details on which components are included with your purchase.



Blood Glucose Meter



Test Strips



Sterile Lancet



Control Solution



Lancing Device



Clear Cap



Carrying Case

Component Descriptions

1. Blood Glucose Meter: Reads the test strips and displays the blood glucose concentration.
2. Test Strips: Strips with a chemical reagent system used with the meter to measure glucose concentration in blood.
3. Lancing Device: Used with sterile lancets to prick the fingertip blood sample collection. The packaged lancing device has multiple depth settings, allowing users to adjust the depth of the puncture and minimize discomfort. It can also eject the used lancets.
4. Clear Cap: Used with the lancing device and sterile lancet to draw a blood sample from the forearm or palm.
5. Sterile Lancets: Used with the lancing device to draw a blood sample. Sterile lancets are inserted into the lancing device with each blood draw and discarded after use.
6. Control Solution: Verifies the proper operation of the blood glucose monitoring system by checking the test strips and meter against a pre-calibrated control solution. Control Solution 1 is all you need most of the time. If you want to do additional levels of test, Control Solution 0 and Control Solution 2 are available. The three levels of control solution, CTRL 0, CTRL 1 and CTRL 2 are available in the *GIMA* Glucose Control Solution package which is sold separately.
7. Carrying Case: Provides portability for blood glucose testing wherever you go.
8. User's Manual: Provides detailed instructions on using the blood glucose monitoring system.
9. Quick Reference Guide: Provides a brief overview of the blood glucose monitoring system and testing procedures. This small guide can be kept in your carrying case.
10. Warranty Card: Should be completed and returned to the distributor to qualify for the 5-year meter warranty.

GIMA Bluetooth® Blood Glucose Meter

The meter reads the test strips and displays the blood glucose concentration. Use these diagrams to become familiar with all the parts of your meter.

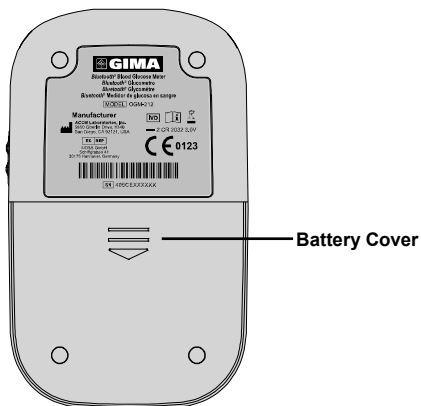
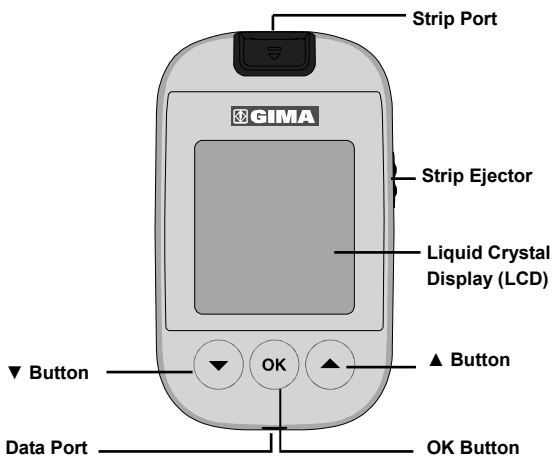

Liquid Crystal Display (LCD): Shows your test results, and helps you through the testing process.

▼ Button: Recalls previous test results from the meter memory and performs other menu selection functions.

▲ Button: Selects meter settings and performs other menu selection functions.

Strip Port: Test strips are inserted into this area to perform a test.

OK Button: Used to manually turn the meter **on** or **off**, check the display to confirm that all the display segments turn on, and check the date/time.

Strip Ejector: Slide the ejector forward to discard the used test strip.

Note: Dispose of blood samples and materials carefully. Treat all blood samples as if they are infectious materials. Follow proper precautions and obey all local regulations when disposing of blood samples and materials.

Battery Cover: Remove the battery cover to install two CR2032 coin cell batteries.

Data Port: Sends information to a computer via an optional data transfer cable to view, analyze and print stored data in the meter. The data transfer cable is available for order as an optional add-on.

Meter Display

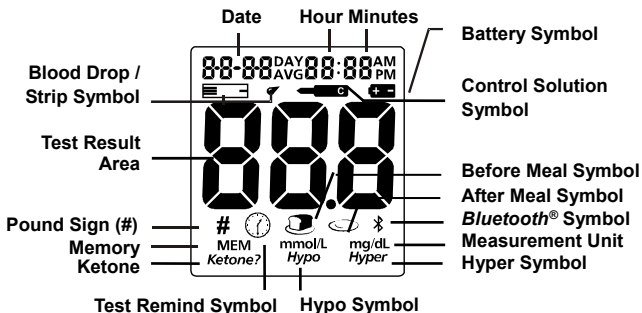

Blood Drop / Strip Symbol: Wait for the Blood Drop / Strip Symbol to appear before applying the sample. These two symbols appear at the same time to tell you when to apply the sample.

Test Result Area: Indicates test result.

Pound Sign (#): Appears with the control solution test result or when you mark an invalid result to prevent it from being included in the average.

MEM: Shows a test result stored in memory.

Ketone: Appears when the blood glucose concentration is above 16.7 mmol/L (300 mg/dL). This simply suggests that a ketone test is recommended. Consult your healthcare professional about testing for ketones.

Note: This symbol does not mean that the system has detected ketones. It recommends that a ketone test should be taken.

Battery Symbol: Warns when you should replace the battery.

Control Solution Symbol: Indicates a control test result. A pound sign (#) will also be displayed when control solution symbol appears.

Before Meal Symbol: Appears when you mark the result as a before-meal test results.

After Meal Symbol: Appears when you mark the result as an after-meal test results.

Measurement Unit: Only one unit will be displayed on your meter and cannot be adjusted.

Hyper Symbol: Appears when the blood glucose concentration is above the target "Hyperglycemia" (high blood sugar) level that you have set.

Hypo Symbol: Appears when the blood glucose concentration is below the "Hypoglycemia" (low blood sugar) target level that you have set.

Test Remind Symbol: Reminding you to test blood glucose.

Meter Use and Precautions

- Wait for the Blood Drop and Strip Symbol to appear together before applying the sample.
- The meter is preset to display blood glucose concentration in either millimoles per liter (mmol/L) or milligrams per deciliter (mg/dL) depending on which unit of measure is standard in your country. This unit of measure cannot be adjusted.
- Meter will shut off automatically 2 minutes after inactivity.
- Do not get water or other liquids inside the meter.
- Keep the strip port area clean.
- Keep your meter dry and avoid exposing it to extreme temperature or humidity. Do not leave it in your car. Please use the meter indoors.
- Do not drop the meter or get it wet. If you do drop the meter or get it wet, check the meter by running a quality control test. Refer to **Performing a Quality Control Test** on page 21 for instructions.
- Do not take the meter apart. Taking the meter apart will void the warranty.
- Refer to the **Maintenance** section on page 42 for details on cleaning the meter.
- Keep the meter and all associated parts out of reach of children.

Note: Follow proper precautions and all local regulations when disposing of the meter and used batteries.

All Glucose Systems Preventive Warnings with Regard to EMC:

- This instrument is tested for immunity to electrostatic discharge as specified in IEC 61000-4-2. However, use of this instrument in a dry environment, especially if synthetic materials are present (synthetic clothing, carpets, etc.) may cause damaging static discharges that may cause erroneous results.
- This instrument complies with the emission and immunity requirements described in EN61326-1 and EN61326-2-6. Do not use this instrument in close proximity to sources of strong electromagnetic radiation, as these may interfere with proper operation of the meter.
- For professional use, the electromagnetic environment should be evaluated prior to operation of this device.

GIMA Blood Glucose Test Strips

The *GIMA* Blood Glucose Test Strips are thin strips with a chemical reagent which work with the *GIMA Bluetooth*[®] Blood Glucose Meter to measure the glucose concentration in whole blood. After the strip is inserted into the meter, blood is applied to the sample tip of the test strip. The blood is then automatically absorbed into the reaction cell where the reaction takes place. A transient electrical current is formed during the reaction and the blood glucose concentration is calculated based on the electrical current detected by the meter. The result is shown on the meter display. The meter is calibrated to display plasma equivalent results.

Sample Tip

Apply blood or control solution here.



Check Window

Check to confirm that a sufficient sample size has been applied.

Contact Bars

Insert this end of the test strip into the meter until it stops.

IMPORTANT: Apply the sample only to the sample tip of the test strip. Do not apply blood or control solution to the top of the test strip as this may result in an inaccurate reading.

Hold the blood drop to the sample tip of the test strip until the check window is completely full and until the meter begins to count down. If you applied blood but do not see the starting of the count down, you may reapply a second drop of blood within 3 seconds. If the check window does not fill and the meter starts to count down, then do not add more blood to the test strip. If you do then you may get an E-5 message or an inaccurate test result. In this case if the meter begins to count down and the check window does not fill, discard the strip and begin the test again with a new test strip.



Correct



Incorrect



Correct

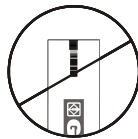

Incorrect

Storage and Handling

Please review the following storage and handling instructions:

- Store test strips in a cool, dry place at 2 - 35 °C (36 - 95 °F). Store them away from heat and direct sunlight.
- Do not freeze or refrigerate.
- Do not store or use test strips in a humid place such as a bathroom.
- Do not store the meter, the test strips or control solution near bleach or cleaners that contain bleach.
- The test strip should be used immediately after removing it from the container.
- Repeated insertion and removal of a test strip into the meter strip port may result in reading errors.
- Do not use your test strips past the unopened expiration date printed on the label. Using test strips past the unopened expiration date may produce incorrect test results.

Note: The expiration date is printed in Year-Month-Date format.

Special Instructions for Test Strip in the Vial

- Test strips must be stored in the original vial with the cap tightly closed. This keeps them in good working condition.
- Do not transfer test strips to a new vial or any other container.
- Replace the cap on the test strip vial immediately after removing a test strip.
- A new vial of test strips may be used for 18 months after being first opened. Write the opened expiration date on the vial label after opening. Discard the vial 18 months after you first open it. Usage after this period may result in inaccurate readings.

Special Instructions for Test Strip in the Foil Pouch

- Tear the pouch carefully starting from the tear gap. Avoid damaging or bending the test strip.
- Use the test strip immediately after removing it from the pouch.

Test Strip Precautions

- For *in vitro* diagnostic use. Test strips are to be used only outside the body for testing purposes.
- Do not use test strips that are torn, bent, or damaged in any way. Do not reuse test strips.
- Keep the test strip vial or the foil pouch away from children and animals.
- Consult your physician or healthcare professional before making any changes in your treatment plan based on your blood glucose test results.

See the test strip insert for more details.

GIMA Glucose Control Solution

The *GIMA* Glucose Control Solution contains a known concentration of glucose. It is used to confirm that your *GIMA Bluetooth*[®] Blood Glucose Meter and test strips are working together properly and that you are performing the test correctly. It is important to run a quality control test regularly to make sure you are getting correct results.

You should run a quality control test:

- Before you first use your meter, to familiarize yourself with its operation.
- Before using a new box of test strips.
- When you suspect that the meter or test strips are not working properly.
- When you suspect that your test results are inaccurate, or if they are inconsistent with how you feel.
- When you suspect your meter is damaged.
- After cleaning your meter.
- At least once a week.



Refer to **Performing a Quality Control Test** on page **21** for instructions on running a quality control test.

Storage and Handling

Please review the following storage and handling instructions:

- Store the control solution at 2 - 35 °C (36 - 95 °F).
- Do not refrigerate or freeze.
- If the control solution is cold, do not use until it has warmed to room temperature.
- Use before the unopened expiration date that is shown on the bottle.
Note: The expiration date is printed in Year-Month-Date format.
- Each bottle of control solution can be used for 6 months after you first open it. Record the opened and the resulting expiration date on the bottle label.

Control Solution Precautions

- For *in vitro* diagnostic use. The control solution is for testing only outside the body. Do not swallow or inject.
- Shake well before using.
- Control solution tests are specified to be accurate only when tested between 10 and 40 °C (50 - 104 °F).
- The control ranges shown on the test strip vial (or on the foil pouch) are not recommended ranges for your blood glucose level. Your personal blood glucose target ranges should be determined by your diabetes healthcare professional.
- Do not touch the test strip with the tip of the control solution bottle.
- Use only the same brand of control solution that was provided with your kit.

See the control solution insert for more details.

Installing the Battery

Batteries may not be preinstalled in the meter. Two CR 2032 3.0 V coin cell batteries are required. Please find the batteries in your carrying case and install them according to the following steps:

1. Turn over the meter to locate the battery cover. Slide the battery cover in the direction of the arrow to open it.

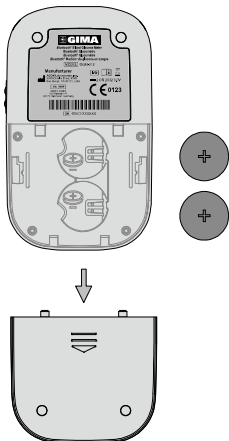

2. Insert two new CR 2032 3.0 V coin cell batteries on top of the plastic tape. Make sure it is aligned with the plus (+) side facing in the battery carrier.

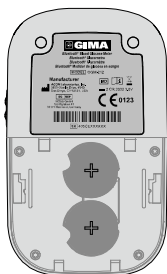

3. Close the battery cover and make sure that it snaps shut.

Meter Setup Before Testing

Before using your meter for the first time, you will need to adjust the settings that are listed in detail below.

1. **Meter Setup Mode:** Press the ▲ button for 2 seconds to enter the meter setup mode. The meter will automatically enter the setup mode when turned on for the first time by any method.
2. **Clock:** Set the clock for either 12 or 24 hour mode. Press the ▼ or ▲ button to switch between the two settings. Then press the **OK** button to save your choice and then start setting the date format.

Note: The clock needs to be reset after replacing the battery.

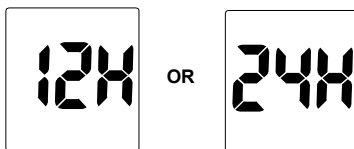

3. **Date Format:** m-d or d-m will appear at the top of the display to indicate either a month-date-year format or a date-month-year format. Press the ▼ or ▲ button to switch between the two settings. Then press the **OK** button to save your choice and then start setting the year, month and date.

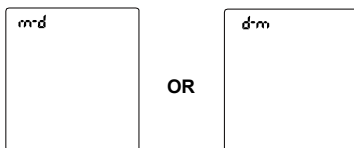

4. **Date:** The year will appear at the top of the display. Press the ▼ or ▲ button to increase or decrease the year. Once you have selected the correct year, press the **OK** button to save your choice and start setting the month. Press the ▼ or ▲ button to increase or decrease the month. Then press the **OK** button to save your choice and start setting the date. Press the ▼ or ▲ button to increase or decrease the date. Then press the **OK** button to save your choice and start setting the time.

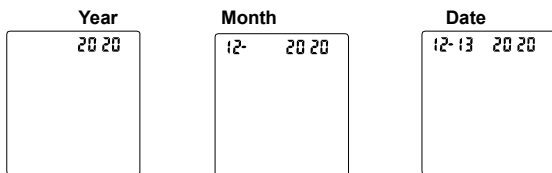

5. **Time:** The hour will appear at the top of the display. Adjust the hour with the ▼ or ▲ button until the correct hour is displayed. Press the **OK** button to save your choice and set the minutes. Press the ▼ or ▲ button to change to the correct minute. Press the **OK** button to save your choice and move to set the meal marker feature.

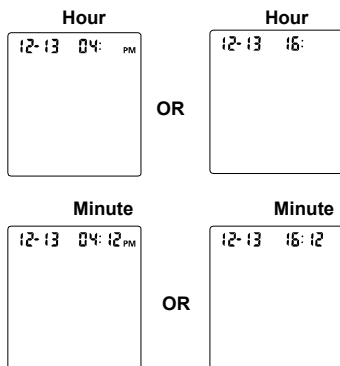

6. **Meal Marker:** The meter comes with the meal marker feature disabled. The meter allows the user to enable or disable the meal marker option. The words “On” or “OFF” will be displayed on the large center segments of the display and the before meal symbol together with the after meal symbol will be displayed as shown below.

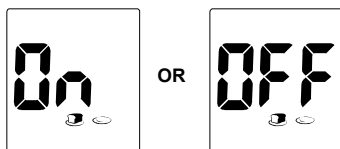

Press the ▼ or ▲ button to switch between turning the meal marker “On” and “Off”. Press the **OK** button to confirm your selection.

7. **Audio Feature:** The meter comes with the meter audio feature enabled. The meter will give one short beep when it is turned on, after sample detection and when the result is ready. The meter will sound three short beeps to sound a warning when an error has occurred. Please check the error number on the display to confirm what kind of error has occurred.

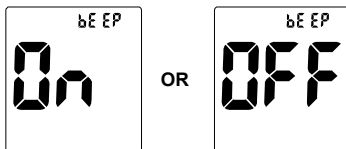

Press the ▼ or ▲ button to switch between turning the meter beep “On” and “Off”. Press the **OK** button to confirm your selection.

8. **Ketone Indicator:** The meter comes with the Ketone indicator feature disabled. Press the ▼ or ▲ button to switch between turning the Ketone indicator “On” and “Off”. Press the **OK** button to confirm your selection. When the Ketone indicator is enabled, if the test result is higher than 16.7 mmol/L (300 mg/dL), the symbol of "Ketone?" will appear on the display.

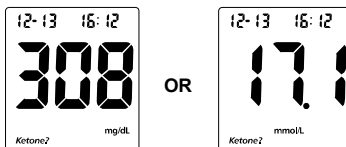

9. **Hyper Indicator:** The meter comes with the Hyper indicator feature disabled. Press the ▼ or ▲ button to switch between turning the Hyper indicator “On” and “Off”. Press the **OK** button to confirm your selection. When the Hyper indicator is “Off”, pressing the **OK** button will go to the next Hypo indicator set up. When the Hyper indicator is “On”, pressing the **OK** button will go to the Hyper indicator level set up. At the Hyper level set up, press the ▼ or ▲ button to adjust the Hyper level then press the **OK** button to go to the Hypo indicator set up.

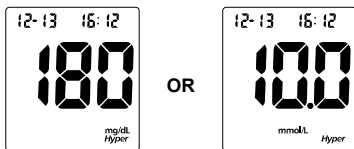

Note: The meter allows the hyperglycemia level to be as low as 6.7 mmol/L (120 mg/dL) or higher. The hyperglycemia level should be above the hypoglycemia level. Consult your diabetes healthcare professional before determining what your hyper blood glucose level is.

10. **Hypo Indicator:** The meter comes with the Hypo indicator feature disabled. Press the ▼ or ▲ button to switch between turning the Hypo indicator “On” and “Off”. Press the **OK** button to confirm your selection. When the Hypo indicator is “Off,” pressing the **OK** button will go to the Test Reminder set up. When the Hypo indicator is “On”, pressing the **OK** button will go to the Hypo indicator level set up. At the Hypo level set up, press the ▼ or ▲ button to adjust the Hypo level then press the **OK** button to go to the Test Reminder set up.

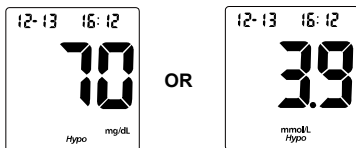

Note: The meter allows the hypoglycemia level to be as high as 5.6 mmol/L (100 mg/dL). The hypoglycemia level should be below the hyperglycemia level. Consult your diabetes healthcare professional before determining what your hypo blood glucose level is.

11. **Test Reminder:** Test reminders are a useful way to remind you when to test. You can set 1 to 5 reminders per day. Your meter is preset with the test reminder disabled. You must turn it on to use this feature.
- Press the ▼ or ▲ button to switch between turning the first Test Reminder “On” and “Off”. Press the **OK** button to confirm your selection. When the Test Reminder is “Off”, pressing the **OK** button will go to the set up of the second Test Reminder. When the Test Reminder is “On”, pressing the **OK** button will go to the set up of the time for the first Test Reminder. Press the ▼ or ▲ button to adjust the first Test Reminder time. Press the **OK** button

to confirm the first Test Reminder time and then go to the second Test Reminder set up.

- When the Test Reminder is "Off" during the second Test Reminder set up, pressing the **OK** button will go to the set up of the third Test Reminder. When the Test Reminder is "On", pressing the **OK** button will go to the set up of the time for the second Test Reminder. Press the **▼** or **▲** button to adjust the second Test Reminder time. Press the **OK** button to confirm the second Test Reminder time and then go to the third Test Reminder set up.
- Repeat the same set up procedure for Test Reminder 3, 4 and 5.

If one or more test reminders have been set, the reminder symbol will always appear on the LCD screen when the meter is turned on. The display sample is shown below.

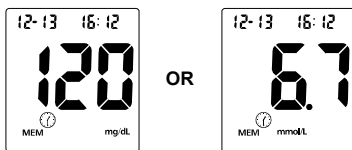

The meter beeps 5 times at the time you set, again two minutes later, and two minutes after that unless you insert a test strip or press any button. This function will still work with Audio feature turned off.

When the meter beeps at the time set by the Test Reminder feature, the date, time and strip symbol will be displayed. And the Test Reminder symbol will be flashed. The display sample is shown below.

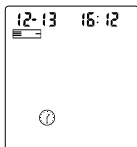

Note: For any step of the set up, if the **▼** or **▲** button is pressed and held, it will allow a faster adjustment.

- 12. Post – Prandial Alarm Function:** The post prandial alarm function is an optional function that you can use to setup a quick test reminder alarm. The alarm has a distinct beep sound that is different from other meter sounds like meal markers and test reminders. You can start setting up an alarm by

pressing ▼ and OK buttons together when the meter is off.



After pressing ▼ and OK buttons, the interface with default 120 min and a clock icon with on/off status will appear on the screen. You can increase the number of minutes by pressing ▲ button and decrease the number of minutes by pressing ▼ button. The time increments are in intervals of 15 minutes. The maximum number of minutes that the post prandial alarm allows user to setup are 480 minutes. The minimum number of minutes that the post prandial alarm allows user to setup are 15 minutes.

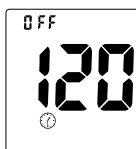

Press OK to confirm and the alarm will beep twice with the clock icon flashing with screen display "On" to indicate that the alarm has been successfully set. You can exit out of the interface by pressing ▼ and OK buttons together, or the meter will be turned off after 60 seconds of inactivity.

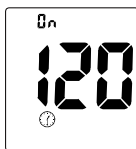

The alarm will beep at the minute mark set by you. You can always go back and change the alarm time if needed after setting up the alarm. To do so,

press ▼ and OK buttons together and the post prandial alarm interface will appear and display the time remaining. You can switch off the alarm by pressing and holding OK button for 2 seconds. You can also navigate and change the alarm time by pressing ▲ or ▼ buttons and re-confirm by pressing OK button. You can always exit out of the post prandial alarm interface by pressing ▼ and OK buttons.

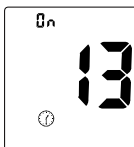

The alarm will beep at the time set by you. The meter screen will display test strip, time and date to remind you to measure your post – prandial blood glucose while the meter beeps. The meter will beep for 20 seconds and alarm will be switched off after 20 seconds. You can snooze the alarm by pressing OK button

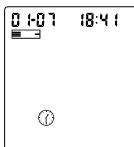

The alarm will be switched off automatically when you insert a test strip.

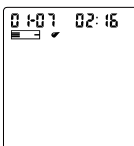

Device Pairing

1. **Bluetooth® Auto-Sending feature:** The meter comes with the *Bluetooth®* auto-sending feature enabled. This feature will allow your glucose result to automatically be sent to your mobile device if the glucose meter and the mobile device are paired and the device and meter are within range. The meter allows the user to enable or disable this option. Press the ▼ or ▲ button to select whether data is automatically sent to the default paired device after each test. The words “bt” “Auto” “On” or “bt” “Auto” “Off” will be displayed on the display. Press the **OK** button to confirm your selection.

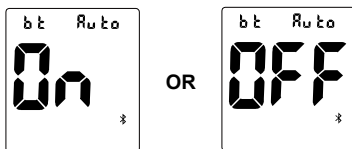

2. **Bluetooth® Pairing:** Before any data can be sent via *Bluetooth®* wireless technology with either the Auto-Sending option or Manual Transmission, the glucose meter and the mobile device must be paired. From this setting, “bt” will appear on the screen with either “yes” or “no” and “pair” at the top of the display. Press the ▲ or ▼ button to change the setting.

If no new devices need to be paired, select the “no” option and press the **OK** button to exit the setup. If you have a new device that needs to be paired with the glucose meter or you have a new meter that has never been paired with a mobile device, select the “yes” option and press the **OK** button to enter pairing mode.

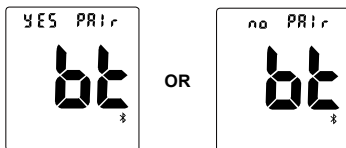

In pairing mode, “bt” displays along with the word “Pair” blinking at the top of the display to indicate the meter is attempting to connect with the mobile device. When prompted to pair by your mobile device, proceed to enter in the last 6 digits of the meter serial number (located on the back of the *Bluetooth®* meter).

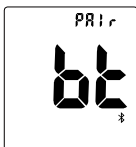

Once the pairing is completed successfully, the word "Pair" stops blinking and the "MEM" symbol displays to show that the device is paired and stored in the meter's memory. Press the **OK** button to exit the setup or the meter will automatically shut off after 30 seconds of inactivity.

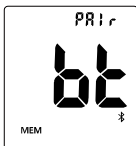

Performing a Quality Control Test

The quality control test confirms that the test strips and meter are working together properly, and that you are performing the test correctly. It is important to perform this test:

- Before you first use your meter.
 - Before using a new box of test strips.
 - When you suspect that the meter or test strips are not working properly.
 - When you suspect that your test results are inaccurate, or if they are inconsistent with how you feel.
 - When you suspect your meter is damaged.
 - After cleaning your meter.
 - At least once a week.
1. Insert a test strip into the strip port, contact bars end first and facing up, to turn on the meter and display all the display segments. If the audio option is on, the meter will beep, signaling the meter is turned on.
 2. Check the display to confirm that all the display segments turn on. Next, a dash will move across the display.



NOT READY



NOT READY

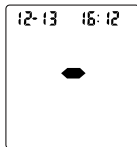

NOT READY

3. The meter is ready for testing when the blinking blood drop and strip symbol appear. The display will show the date time and the strip icon with the blood sample icon blinking to indicate that the test strip is inserted correctly. You can then add a drop of control solution.

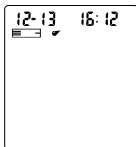

READY TO TEST

Note: If the test strip has been inserted incorrectly, the meter will not turn on.

- Shake the control solution bottle well, then squeeze it gently and discard the first drop. If the tip clogs, tap the tip gently on a clean, hard surface. Then shake again and use. Squeeze out a second small drop on a clean nonabsorbent surface. Touch the sample tip of the test strip to the control solution drop. If the audio option is turned on, the meter will beep to indicate a sufficient sample has been applied.

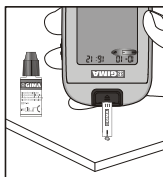

Notes:

- Do not apply control solution to the test strip directly from the bottle.
 - If you applied the control solution sample but do not see the starting of the count down, you may reapply a second drop within 3 seconds.
- Once a sufficient sample has been applied, the meter display will count down from 5 to 1 and then the result and a control solution symbol will be displayed on the screen. The control solution test results should be within the control range (CTRL 1) printed on the test strip vial (or on the foil pouch). This means that your blood glucose monitoring system is working properly and that you are performing the procedure correctly.

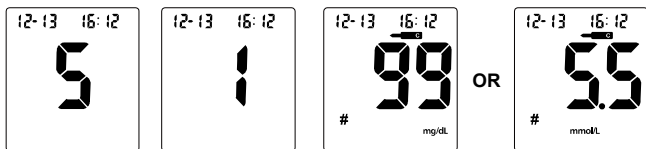

Test results are displayed either in mmol/L or mg/dL depending on the unit of measure most common in your country. .

Note: The control solution range is the expected range for the control solution results. It is not a recommended range for a blood glucose level.

- If the *Bluetooth*[®] Auto-Sending feature is turned on, the meter will instantly go into automatic *Bluetooth*[®] transmission mode after displaying the control result. Please refer to **Testing Your Blood part** in page 30.

7. After transmission finished or if you don't want to transfer data, press **OK** button to turn off the meter and slide forward the strip ejector to discard the used test strip.

The display should also show a pound sign (#) indicating the test is a control solution test. This shows that the number will not be counted in the 7, 14, 30, 60 and 90-day averages. The pound sign (#) will also be displayed when reviewing the results stored in memory.

If the result falls outside the indicated control range:

- Confirm you are matching the correct range. Control Solution 1 results should be matched to the CTRL 1 range printed on the test strip vial (or on the foil pouch).
- Check the expiration date of the test strip and control solution. Discard any test strips or control solution that has expired.
- Confirm the temperature in which you are testing is between 10 and 40 °C (50 – 104 °F).
- Make sure that the test strip vial and control solution bottle have been tightly capped.
- Confirm that you are using the same brand of control solution that was provided with your kit.
- Make sure that you followed the test procedure correctly.

After checking all of the conditions listed above, repeat the quality control test with a new test strip. If your results still fall outside of the control range shown on the test strip vial (or on the foil pouch), your meter may be defective. Contact your local distributor for help.

Three levels of control solution are available labeled Control Solution 0, Control Solution 1 and Control Solution 2. Control Solution 1 is sufficient for most all self-testing needs. If you think your meter or strips may not be working correctly, you may also want to perform a CTRL 0 or CTRL 2 test. The ranges for CTRL 0, CTRL 1 and CTRL 2 are displayed on the test strip vial (or on the foil pouch). Simply repeat step 4 through 6, using Control Solution 0 or Control Solution 2.

For confirmation of results, Control Solution 0 tests should fall within the CTRL 0 range, Control Solution 1 tests should fall within the CTRL 1 range and Control Solution 2 tests should fall within the CTRL 2 range. If the control solution test results do not fall within the respective ranges, DO NOT use the system to test blood, as the system may not be working properly. If you cannot fix the problem, contact your local distributor for help.

Please contact your local distributor for information on ordering the *G/MA* Glucose Control Solution kit, which contains Control Solution 0, Control Solution 1 and Control Solution 2.

Testing Your Blood

The following steps will show how to use the meter, test strips, lancing device and sterile lancets together to measure your blood glucose concentration.

Step 1 – Getting a Drop of Blood

The *GIMA Bluetooth*[®] Blood Glucose Monitoring System requires a very small drop of blood which may be obtained from the fingertip, palm (at base of the thumb) or forearm. Before testing, choose a clean, dry work surface. Familiarize yourself with the procedure and make sure you have all the items needed to obtain a drop of blood.

IMPORTANT: Prior to testing, wipe the test site with an alcohol swab or soapy water. Use warm water to increase blood flow if necessary. Then dry your hands and the test site thoroughly. Make sure there is no alcohol, soap, cream or lotion on the test site.

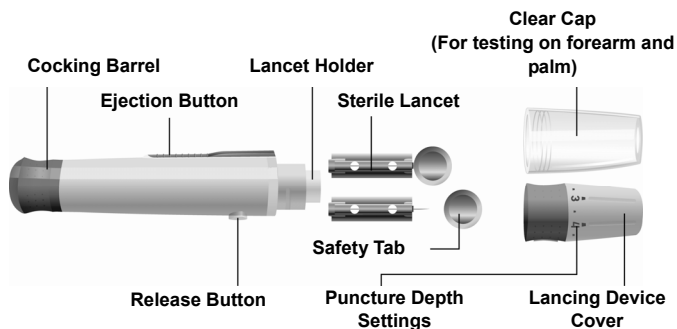

Fingertip Testing

For fingertip sampling, adjust the depth penetration to reduce the discomfort.

1. Unscrew the lancing device cover from the body of the lancing device. Insert a sterile lancet into the lancing device and push it until the lancet comes to a complete stop in the lancing device.

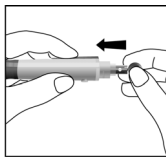
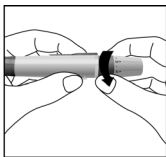

2. Hold the lancet firmly in the lancing device and twist the safety tab of the lancet until it loosens. Then pull the safety tab off the lancet. Save the safety tab for lancet disposal.
3. Carefully screw the cover back onto the lancing device. Avoid contact with the exposed needle. Make sure the cover is fully sealed on the lancing device.

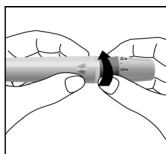
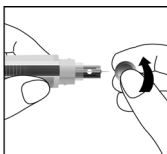

4. Adjust the puncture depth by rotating the lancing device cover. There are a total of 11 puncture depth settings. To reduce the discomfort, use the lowest setting that still produces an adequate drop of blood.

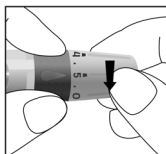
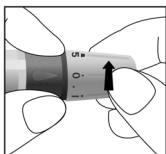

Adjustments:

- 0 - 1.5 for delicate skin
- 2 - 3.5 for normal skin
- 4 - 5 for calloused or thick skin

Note: Greater pressure of the lancing device against the finger will also increase the puncture depth.

5. Pull the cocking barrel back to set the lancing device. You may hear a click while the release button changes to orange to indicate the lancing device is now loaded and ready for obtaining a drop of blood.

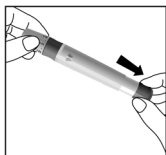

6. Prior to testing, clean your hands with an alcohol wipe or wash your hands with soap. Use warm water to increase blood flow in your fingers if necessary. Then dry your hands thoroughly. Massage the hand from the wrist up to the fingertip a few times to encourage blood flow.

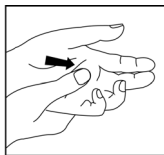
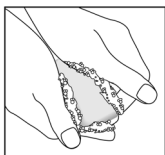

7. Hold the lancing device against the side of the finger to be lanced with the cover resting on the finger. Push the release button to prick your fingertip. You should hear a click as the lancing device activates. Gently massage your finger from the base of the finger to the tip of the finger to obtain the required blood volume. Avoid smearing the drop of blood.

For the greatest reduction in pain, lance on the sides of the fingertips. Rotation of sites is recommended. Repeated punctures in the same spot can make your fingers sore and callused.

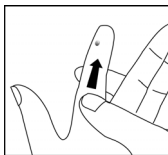
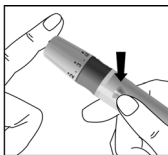

Forearm and Palm Testing

The forearm and palm areas have less nerve endings than the fingertip. You may find that obtaining blood from these sites is less painful than from the fingertip. The procedure for forearm and palm sampling is different. You need the clear cap to draw blood from these sites. The clear cap is not adjustable for puncture depth.

IMPORTANT: There are important differences among forearm, palm and fingertip

samples that you should know. Important Information about forearm and palm glucose testing:

- You should consult your healthcare professional before choosing to perform forearm or palm testing.
- When blood levels are changing rapidly such as after a meal, insulin dose or exercise, blood from the fingertips may show these changes more rapidly than blood from other areas.
- Fingertips should be used if testing is within 2 hours of a meal, insulin dose or exercise and any time you feel glucose levels are changing rapidly.
- You should test with the fingertips anytime there is a concern for hypoglycemia or you suffer from hypoglycemia unawareness.

Please refer to **Fingertip Testing** to insert the lancet and load the lancing device.

1. Screw the clear cap onto the lancing device.

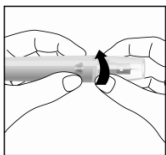

2. Choose a puncture site on the forearm or palm. Select a soft and fleshy area of the forearm and palm that is clean and dry, away from bone, and free of visible veins and hair.

To bring fresh blood to the surface of the puncture site, massage the puncture site vigorously for a few seconds until you feel it getting warm.

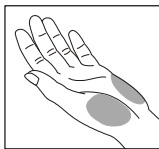
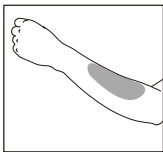

3. Place the lancing device against the puncture site. Press and hold the clear cap against the puncture site for a few seconds. Press the release button of the lancing device, but **do not immediately lift the lancing device** from the puncture site. Continue to hold the lancing device against the puncture site until you can confirm a sufficient blood sample has formed.

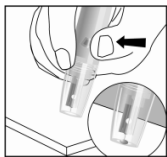

Disposal of the Lancet

1. Unscrew the lancing device cover. Place the safety tab of the lancet on a hard surface. Then carefully insert the lancet needle into the safety tab.
2. Press the release button to make sure that the lancet is in the extended position. Slide the ejection button forward to discard the used lancet. Place the lancing device cover back on the lancing device.

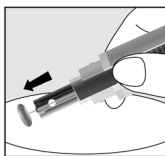
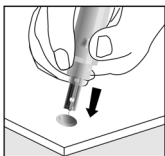

Lancet Precautions

- Do not use the lancet if the safety tab is missing or loose when you take the lancet out of the bag.
- Do not use the lancet if the needle is bent.
- Use with caution whenever the lancet needle is exposed.
- Never share lancets or the lancing device with other people.
- In order to reduce the risk of infection from prior use of the instrument, always use a new, sterile lancet. Do not reuse lancets.
- Avoid getting the lancing device or lancets dirty with hand lotion, oils, dirt or debris.

Step 2 – Testing Blood Glucose

Note: Insertion of a new test strip at any time, except while in the data transfer mode (detailed on page 38) will cause the meter to automatically enter the test mode.

1. Insert a test strip into the strip port, contact bars end first and facing up, to turn on the meter and display all the display segments. If the audio option is on, the meter will beep, signaling the meter is turned on. The display will turn on briefly with all the icons and segments turned on. Check the display to confirm that all the display segments turn on with no missing components.

The display will then show only the date and time, with a dash moving across the display. Check the display to ensure no inappropriate segments or icons are permanently turned on.



NOT READY



NOT READY

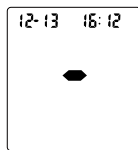

NOT READY

2. Following this display check, the system will enter the test mode. The display will show the date and time and the strip icon with the blood sample icon blinking, to indicate that the test strip is inserted correctly and a drop of blood can be added. If the test strip has been inserted incorrectly, the meter will not turn on. The meter is ready for testing when the blinking blood drop and strip symbol appears. At this time a blood drop can be added.

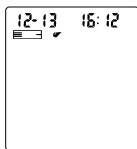

READY TO TEST

3. Touch the blood sample to the sample tip at the end of the test strip. If the audio option is turned on, the meter will also beep to indicate the sample is sufficient and the measurement has started. If you applied a drop of blood, but do not see the starting of the count down, you may reapply a second drop of

blood within 3 seconds.

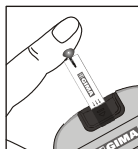
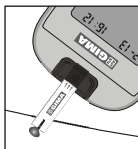

DO NOT:

- Apply sample to the front or back of the test strip.
 - Smear the blood drop onto the test strip.
 - Press your finger against the test strip.
4. The meter will count down from 5 to 1 and then display the measurement results. The meter will also beep to indicate that measurement is complete. Then your blood glucose level will display on the screen, along with the unit measurement, date, and time of the test.

Blood Glucose results are automatically stored in the memory. When the meal marker feature is turned off and a test result is displayed, to mark invalid results and to prevent them from being included in the 7, 14, 30, 60 and 90-day averages, press the ▼ and ▲ button together, when a pound sign (#) appear on the display, then press OK button. A pound sign (#) means that the result will not be included when calculating the 7, 14, 30, 60 and 90-day averages. If a result is marked by accident, press the ▼ and ▲ button together and then press the ▼ or ▲ to unmark the result. After marking the invalid result, run the test again with a new test strip.

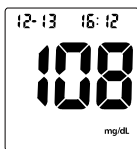
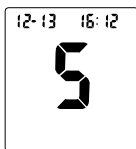

OR



When the meal marker feature is turned on and a test result is displayed, mark the result as “before meal”, “after meal”, or invalid.

- Press the ▼ and ▲ button to display the “before meal marker” symbol, indicating the result was taken before a meal.
- Press the ▼ or ▲ button again to display the “after meal marker” symbol, indicating the result was taken after a meal.

- Press the ▼ or ▲ button again to display the pound sign (#), indicating an invalid result.
- Press the ▼ or ▲ button again then none of the above markers will be displayed for the result.

After deciding the selection, press the **OK** to confirm the selection as either “before meal marker”, “after meal marker”, “invalid result” with pound sign (#) or none of these three symbols. If an invalid result is marked, run the test again with a new test strip.

When the *Bluetooth*® Auto-Sending feature is turned on and the meal marker feature is turned on, the meter allows the user 15 seconds to change the meal marker before going into *Bluetooth*® automatic transmission mode. If the *Bluetooth*® Auto-Sending feature is turned on but the meal marker feature is not, the meter will instantly go into *Bluetooth*® automatic transmission mode after displaying the glucose result.

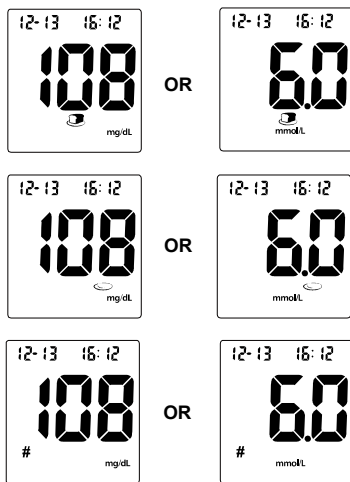

When the meter starts transmitting data, the glucose reading remains on the display and the words “bt” and “to” appear at the top of the display.

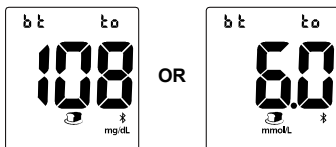

Once the transmission has finished, the words “bt” and “sent” appear at the top of the display.

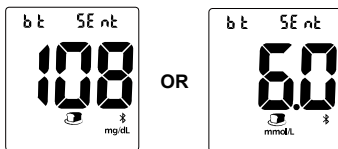

If the transmission was interrupted and the data transfer failed, the words “not” and “sent” appear at the top of the display.

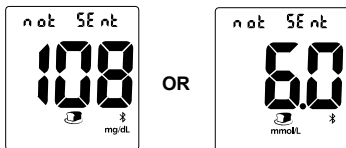

If an error message appears on the display, refer to the **Troubleshooting Guide** on **page 46**. If a “HI” or “LO” error appears on the display, refer to “HI” and “LO” messages below.

- After inspection, record valid results in your logbook with the date and time, and compare them to the target goals set by your diabetes healthcare professional. Refer to **Suggested Testing Times and Target Goals** on **page 44** for more details on your target blood glucose concentration goals.
- Slide forward the strip ejector to discard the used test strip.



Note: Dispose of blood samples and materials carefully. Treat all blood samples as if they are infectious materials. Follow proper precautions and obey all local regulations when disposing of blood samples and materials.

“HI” and “LO” Messages

The meter can accurately measure blood glucose concentrations between 0.6 to 33.3 mmol/L (10 to 600 mg/dL). “HI” and “LO” messages indicate results outside of this range.

If “HI” appears on the display, the measured concentration value is above 33.3 mmol/L (600 mg/dL). The test should be retaken to ensure that no mistake was made in the procedure. If you are certain the meter is functioning properly and no mistakes were made in the procedure, and your blood glucose is still consistently measured as “HI”, it indicates severe hyperglycemia (high blood glucose). You should contact your healthcare professional immediately.

If “LO” appears on the display, the measured concentration value is below 0.6 mmol/L (10 mg/dL). The test should be retaken to ensure that no mistake was made in the procedure. If you are certain the meter is functioning properly and no mistakes were made in the procedure, and your blood glucose is still consistently measured as “LO”, it may indicate severe hypoglycemia (low blood glucose). You should treat yourself for hypoglycemia immediately as recommended by your healthcare professional.

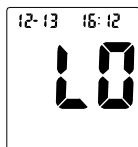
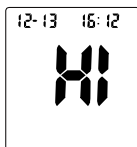

“Hypo” and “Hyper” Messages

If “Hypo” appears on the display, the measured concentration value is below the “Hypo” (low blood sugar) target level that you have set.

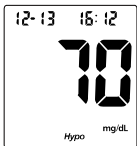

OR



If “Hyper” appears on the display, the measured concentration value is above the “Hyper” (high blood sugar) target level that you have set.

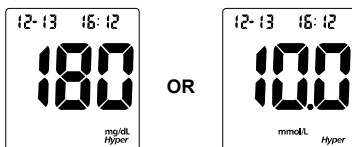

“Ketone” Message

If “Ketone?” appears on the display, the measured concentration value is above 16.7 mmol/L (300 mg/dL). This simply suggests that a ketone test is recommended. Consult your healthcare professional about testing for ketones.

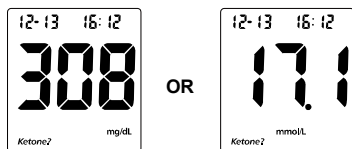

Precautions and Limitations

Please refer to the test strip insert.

Using the Meter Memory

The meter automatically stores up to 1000 test records. Each record includes the test result, time and date. If there are already 1000 records in memory, the oldest record will be erased to make room for a new one.

The meter will also calculate the average values of records from the last 7, 14, 30, 60 and 90 days.

Viewing Stored Records

To view stored records:

1. Press the ▼ button to turn the meter on and enter memory mode. The most recent value and the word “MEM” will appear on the display.

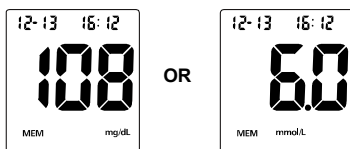

2. If you are using the meter for the very first time, the meter display will show three dashed lines (- - -), the word “MEM” and the unit of measure. This shows that no data have been stored in memory.

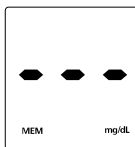

3. The date and time will be displayed together with the results stored in memory. A pound sign (#) indicates records that will be omitted from the 7, 14, 30, 60 and 90-day averages.
4. Press the ▼ or ▲ button to view the previous or next stored records.

Press the **OK** button to view the data averages. The words “DAY AVG” will appear on the screen.

Note: If you do not wish to view your average glucose measurements, you can press the ▼ button to return to see stored records, or press **OK** button again to turn off the display.

5. While in data average mode:

- If the meal marker feature is off, press the ▲ button to switch between the general 7, 14, 30, 60 and 90-day averages.
- If the meal marker feature is on, press the ▲ button to switch between the general, pre-meal and post-meal 7, 14, 30, 60 and 90-day averages.

The meter will calculate the average that you selected. The number of records used in the DAY AVG will also appear in the display.

Note: Only test results that have been marked as “before meal” or “after meal” are included in pre-meal and post-meal averages. All blood glucose results are included in the general 7, 14, 30, 60 and 90-day averages.

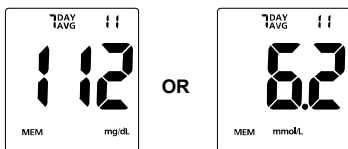

6. If there are fewer than 7, 14, 30, 60 and 90 days in memory, all the readings without the pound (#) sign currently stored in memory will be averaged.
7. If you are using the meter for the very first time, no value will appear on the display. This means that no records have been stored in memory. If you have not marked any results as “before meal” or “after meal”, no value will appear on the display for the pre-meal or post-meal averages. This means that no records have been stored as “before meal” or “after meal” in memory.
8. Press the **OK** button to turn off the display.

Note: Results from quality control tests will not be included in the averages. When viewing results in memory, these values are marked with a pound sign (#) to show that they will not be included in the 7, 14, 30, 60 and 90-day averages.

Clearing the Memory

Take extreme caution when clearing the memory. This is not a reversible operation. To clear the memory:

1. With the meter off, press and hold the ▼ button for two seconds. This will turn on the meter and enter the delete mode.



2. To clear the memory, press and hold both the ▼ and ▲ buttons together for two seconds.
3. The display will show "MEM" and "---", the meter will clear its memory and turn itself off after a moment.

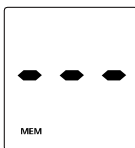

4. If you entered the delete mode but want to exit without deleting the recorded data, press the **OK** button. This will turn the meter off without deleting any data.

Data Transfer Using Data Cable

The meter can transfer stored information to a Windows-based personal computer (PC) using an optional data transfer cable and software package. To make use of this feature, you need the *GIMA* Diabetes Management Software and a data transfer cable from *GIMA*.

1. Install the software to your personal computer (PC) according to the instructions from the *GIMA* Diabetes Management Software Kit.
2. Connect the USB cable to your PC and plug the audio jack of the cable into the meter data port. Meter will automatically turn itself into "PC" mode.



Notes:

- When strip is already inserted into the meter and meter is in the waiting for sample application mode, at this point if data transfer cable is plugged into meter data port then meter gives E-12 error message and does not automatically turn to “PC” mode.
 - When meter is in “PC” mode, meter does not turn to waiting for sample application mode after strip is inserted into meter.
3. Run the *GIMA* Diabetes Management Software, and refer to the instructions from the software for how to transfer records.
 4. During the data transfer, the meter will display “to” and “PC”. This indicates the data is being transferred from the meter to the PC.



5. Once the data transfer is complete, the meter will display “End” and “PC”.

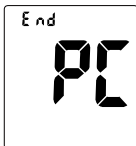

6. After data transfer from meter to PC is completed, press the **OK** button to turn off the meter. If nothing else happens to meter 2 minutes after data transfer from meter to PC is completed, the meter will automatically turn off. In this case, plug the audio jack of the cable into the meter data port to enter “PC” mode again.

Note: Peripheral equipment such as computer which is intended to be connected with meter shall conform to relevant safety standard.

See the package insert included with your *GIMA* Diabetes Management Software Kit for detailed instructions.

Manually Transfer Records via *Bluetooth*[®] wireless technology

Instead of transferring data immediately after complete the blood glucose measurement when auto-sending function is on, the meter can also wirelessly transfer your stored diabetes information manually when you choose to send the data. You will need a mobile application on your mobile device to accept the meter's data. Consult your local distributor for current mobile app compatibility.

1. Turn on *Bluetooth*[®] function to the discoverable state and launch the App in your mobile device to connect to the glucose meter. Press and hold both the ▼ and ▲ buttons for two seconds. The meter will display "bt" mode along with word "to" blinking to indicate the meter is attempting to connect wirelessly to the mobile device. After several seconds, the word "to" will stop blinking, indicating a successful connection to the mobile device.

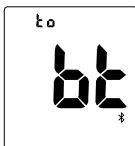

Note: When meter is in "bt" mode, sample application mode cannot be activated after a strip is inserted into the meter. Do not insert test strips and attempt to test blood glucose while the meter is in "bt" mode.

2. Once the data transfer is complete, the meter will display "End" and "bt".

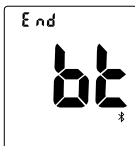

3. After data transfer from meter to your device is complete, press the **OK** button to turn off the meter. If nothing else happens 5 seconds after data transfer is completed, the meter will automatically turn off. In this case press both the ▼ and ▲ buttons to enter "bt" mode again if needed.

Warning: Never break the connection between the meter and mobile device while data transferring is in progress, for example by turning off the meter or removing the battery. Do not put the *GIMA Bluetooth*[®] Meter on a metal surface or in a metal box or enclosure. This may affect its ability to transfer data.

Compliance Information

Bluetooth® Notice

The *Bluetooth®* word mark and logos are registered trademarks owned by the Bluetooth SIG, Inc. and any use of such marks by **GIMA** is under license. Other trademarks and trade names are those of their respective owners.

Maintenance

Proper maintenance is recommended for best results.

Replacing the Battery

Your *GIMA Bluetooth*[®] Meter uses two 3.0 Volt CR 2032 lithium batteries.

When the battery icon () is blinking, it means the battery is running low. You should replace the battery as soon as possible. An “E-6” error message will appear if the battery is too low to perform any more blood glucose tests. The meter will not function until the battery is replaced.

Note: Make sure to replace the used up batteries with two new ones.

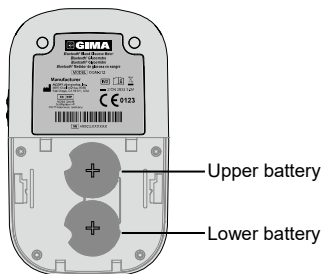

Instructions:

1. Turn the meter off before removing the batteries.
2. Turn the meter over to locate the battery cover. Slide the battery cover in the direction of the arrow to open it.
3. Remove and discard the old batteries. Insert two new CR 2032 3.0 V coin cell batteries in the battery carriers. Make sure the plus (+) side facing up.
4. Close the battery cover and make sure that it snaps shut.
5. Recheck and reset the clock setting after battery replacement, if necessary. To set the meter clock, see **Meter Setup Before Testing** on page 12.

Caring for Your *GIMA Bluetooth*[®] Blood Glucose Monitoring System

Blood Glucose Meter

Your *GIMA Bluetooth*[®] Blood Glucose Meter does not require special maintenance or cleaning. A cloth dampened with water and a mild detergent solution can be used to wipe the outside of the meter. Take care to avoid getting liquids, dirt, blood or control solution into the meter through the strip or data ports. It is recommended that you store the meter in the carrying case after each use.

The *GIMA Bluetooth*[®] Blood Glucose Meter is a precision electronic instrument. Please handle it with care.

Lancing Device

Use mild soap and warm water to clean with a soft cloth as required. Carefully dry the device thoroughly. Do not immerse the lancing device.

Please refer to the lancing device insert for more details.

Suggested Testing Times and Target Goals

Tracking your blood glucose concentration through frequent testing is an important part of proper diabetes care. Your healthcare professional will help you to decide the normal target range for your glucose levels. They will also help you to determine when and how often to test your blood glucose. Some suggested times are:

- When you wake up (fasting level)
- Before breakfast
- 1-2 hours after breakfast
- Before lunch
- 1-2 hours after lunch
- Before or after exercise
- Before dinner
- 1-2 hours after dinner
- Before bedtime
- After a snack
- At 2 or 3 AM, if taking insulin

You may need to test more often whenever¹:

- You add or adjust your medication for diabetes.
- You think your blood glucose levels may be too low or too high.
- You are ill, or feeling uncomfortable over long periods of time.

Expected blood glucose levels for people without diabetes²:

| Time | Range, mg/dL | Range, mmol/L |
|--------------------------|---------------|---------------|
| Fasting and Before Meals | 70 - 100 | 3.9 - 5.6 |
| 2 Hours after Meals | Less than 140 | Less than 7.8 |

Talk to your healthcare professional to set your own daily target ranges.

| Time of Day | Your Target Range |
|---------------------------|-------------------|
| Waking up (Fasting level) | |
| Before meals | |
| 2 hours after meals | |
| Bedtime | |
| 2 AM to 3 AM | |
| Other | |

(Note: 1 mmol/L = 18 mg/dL)

Use the logbook to record your blood glucose measurements and related information. Bring the logbook with you when you visit your doctor so that you can determine how well your blood glucose is being controlled. This can help you and your healthcare professional make the best decisions about your glucose control plan.

1. Jennifer Mayfield and Stephen Havas, "Self-Control: A Physician's Guide to Blood Glucose Monitoring in the Management of Diabetes – An American Family Physician Monograph"
2. ADA, Standards of Medical Care in Diabetes-2021

Comparing Meter and Laboratory Results

Your *GIMA Bluetooth*[®] Blood Glucose System and laboratory results both report the glucose concentration in the serum or plasma component of your blood. However, the results may differ somewhat due to normal variation. The meter results can be affected by factors and conditions that do not affect laboratory results in the same way. See *GIMA* Test Strip package insert for typical accuracy and precision data, and for important information on Limitations.

To ensure a reasonable comparison, follow these guidelines.

Before you go to the lab:

- Bring your meter, test strips and control solution with you to the lab.
- Make sure your meter is clean.
- Perform a quality control test to make sure the meter is working properly.
- Comparisons will be more accurate if you do not eat for at least four hours (preferably eight hours) before testing.

At the lab:

- Wash your hands before obtaining a blood sample.
- Obtain blood samples for a laboratory test and for your meter within 10 minutes of each other. This will ensure an accurate comparison of results.
- Never use your meter with blood that has been placed in test tubes containing fluoride or other anticoagulants. This will cause falsely low results.

Troubleshooting Guide

The meter has built-in messages to alert you of problems. When error messages appear, note the error number, turn off the meter and then follow these instructions.

| Display | Causes | Solution |
|------------------------|---|--|
| Meter fails to turn on | Battery may be damaged or not be charged | Replace battery. |
| | Meter is too cold | If meter has been exposed to or stored in cold conditions, wait 30 minutes to allow the meter to reach room temperature then repeat the test. |
| E-0 | Power On self check error | Remove the batteries for 30 seconds and then put them back and turn meter on again. If the problem persists, please contact your local distributor. |
| E-1 | Internal calibration check error | Turn off meter or remove test strip, and then turn on meter again to retest. If the problem persists, please contact your local distributor. |
| E-2 | Test strip was removed during the test | Repeat the test and ensure test strip remains in place. |
| E-3 | Sample was applied to the test strip too soon | Repeat test and apply sample after blood drop/test strip symbol appears. |
| E-4 | Test strip is contaminated or used | Repeat test with a new test strip. |
| | Sample was applied to the test strip too soon | Repeat test and apply sample after blood drop/test strip symbol appears. |
| E-5 | Insufficient sample | Repeat the test and apply enough sample to fill the test strip check window. |
| | Sample application error due to late sample re-dosing | Repeat the test and apply enough sample to fill the test strip check window within 3 seconds. |

| Display | Causes | Solution |
|------------------|---|---|
| HIT | Temperature has exceeded the operating temperature of the system | Move to a cooler environment and repeat the test. |
| LOt | Temperature is below the operating temperature of the system | Move to a warmer environment and repeat the test. |
| + - | Battery is discharged but has enough power to run 20 more tests | Test results will still be accurate, but replace the two batteries as soon as possible. |
| E-6 ⁻ | Battery is discharged and meter does not allow more tests until replacement with a new battery | Replace the two batteries and repeat the test. |
| E-8 | Meter electronics failure | If the problem persists, please contact your local distributor. |
| E-9 | Damaged test strip or calibration error | Please test again by using a new strip. If the problem persists, please contact your local distributor. |
| E 10 | Communications failure | There is an error in transferring data to the PC. See the package insert included in the <i>GIMA</i> Diabetes Management Software for troubleshooting. |
| E 11 | <ul style="list-style-type: none"> • Strip testing error • Sample Perturbation | Repeat the test and apply enough sample to fill the test strip check window within 3 seconds. When repeat testing, do not touch the strip during meter count down. Please make sure fresh blood sample with intended hematocrit level is used. Please make sure blood sample is not contaminated. If the problem persists, please contact your local distributor. |
| E 12 | Meter data port is plugged in with data transfer cable when meter is in waiting for sample application mode with strip already inserted into the meter strip port | Unplug the data transfer cable from the meter's data port. Then remove the strip. Reinsert the strip into the strip port for testing. If the problem persists, please contact your local distributor. |

Specifications

| Feature | Specification |
|--|---|
| Meter Model Number | OGM-212 |
| Measurement Range | 0.6 - 33.3 mmol/L (10 – 600 mg/dL) |
| Result Calibration | Plasma-equivalent, calibrated by using YSI (Model 2300 STAT PLUS) Glucose Analyzer reference instrument, which is traceable to NIST reference standard. |
| Sample | Capillary, Venous, Arterial, Neonatal blood samples |
| Minimum Sample Size | 0.6 μ L |
| Test Time | 5 seconds |
| On/Off Source | Two (2) CR 2032 3.0 V coin cell batteries |
| Battery Life | 3,000 tests for glucose testing (not considering data transfer) |
| Glucose Units of Measure | The meter is preset to either millimoles per liter (mmol/L) or milligrams per deciliter (mg/dL) depending on the standard of your country. |
| Memory | Up to 1000 records with time and date |
| Automatic shutoff | 2 minutes after last action |
| Meter Size | 90 mm \times 60 mm \times 16 mm |
| Display Size | 43 mm \times 40 mm |
| Weight | 72 g (with batteries installed) |
| Operation Environmental Conditions | Temperature: 5 - 45 $^{\circ}$ C (41 – 113 $^{\circ}$ F); Relative Humidity: 10 - 90% (non-condensing); Altitude: \leq 3048m |
| Meter storage and transportation conditions: | Temperature: -20-50 $^{\circ}$ C (-4 – 122 $^{\circ}$ F) Relative humidity: 10%-93% (non-condensing); Air pressure: 500 hPa ~1060 hPa |
| Hematocrit Range | 10 - 70% |
| Data Port | 9600 baud, 8 data bits, 1 stop bit, no parity |
| Pollution Degree | 2 |
| Means of protection | Class III |
| Marketed Degree of Protection | IPX0 |

Warranty



















Please complete the warranty card that came with this product and mail it to your local distributor to register your purchase.

If the meter fails to work for any reason other than obvious abuse within the first five (5) years from purchase, we will replace it with a new meter free of charge. For your records, also write the purchase date of your product here.

Date of purchase: _____

Note: This warranty applies only to the meter in the original purchase, and does not apply to the battery supplied with the meter.

Index of Symbols

| | |
|---|---|
|  | Consult instructions for use |
|  | <i>In vitro</i> diagnostic medical device |
|  | Temperature limit |
|  | Contains sufficient for <n> tests |
|  | Use by |
|  | Lot Number |
|  | Manufacturer |
|  | Authorized representative in the European Community |
|  | Sterilized using irradiation |
|  | Control Range |
|  | Catalog number |
|  | Serial Number |
|  | Model Number |
|  | Do not dispose along with household waste |
|  | Do not reuse |
|  | Humidity limitation |
|  | Atmospheric pressure limitation |
|  | Direct current |
|  | Data transmission port |

Index

| | |
|--------------------------------------|-----------|
| Averaging Results | 37 |
| Battery, Replacing the | 42 |
| Carrying Case | 1 |
| Clearing the Memory | 38 |
| Data Port | 3, 4 |
| Date Format | 8, 10, 12 |
| Device Pairing | 19 |
| Guidelines | i |
| Hematocrit | 48 |
| Hyperglycemia | 14, 34 |
| Hypoglycemia | 15, 34 |
| Ketones | 14, 35 |
| Lancets | 1, 25 |
| Lancing Device | 1, 25, 43 |
| Maintenance | 6, 42 |
| Measure, Unit of | 5, 22 |
| Meter | 3 |
| "HI" and "LO" Messages..... | 34 |
| ▲ Button..... | 3 |
| ▼ Button..... | 3 |
| Audio feature..... | 14 |
| Cleaning..... | 43 |
| Display..... | 5 |
| Error Messages..... | 46, 47 |
| Memory..... | 36 |
| Meter Setup..... | 12 |
| Meter Use and Precautions...6 | |
| OK Button..... | 3 |
| Set the Clock..... | 12 |
| Specifications..... | 48 |
| Strip ejector..... | 3, 33 |
| Procedure | |
| Precautions and Limitations..... | 35 |
| Testing Your Blood..... | 25 |
| Quality Control Test | 21 |
| Control Solution..... | 9 |
| How to Run..... | 21 |
| Results | |
| Blood Glucose..... | 31 |
| Control Solution..... | 9, 22 |
| Meter vs. Lab Results..... | 45 |
| Target Goals..... | 44 |
| Unit of Measure..... | 22, 44 |
| Suggested Testing Times | 44 |
| Symbols, Index of | 50 |
| Test Strip | 7 |
| Expiration..... | 8 |
| Precautions..... | 9 |
| Testing Your Blood | 25 |
| Get a Drop of Blood..... | 25 |
| Test Blood Glucose..... | 30 |
| Troubleshooting | 46, 47 |
| Viewing Stored Records | 36 |
| Warranty | 2, 49 |

