

seca 761
seca 750/760
seca 762

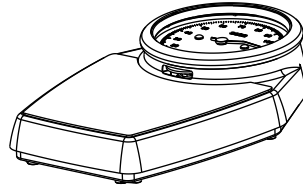
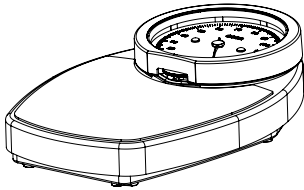

CONTENTS

1. Device description	3
1.1 Intended use	3
1.2 Functional description	3
1.3 User qualification	3
2. Safety information	4
2.1 Safety information in this manual	4
2.2 Basic safety precautions	4
Handling the instrument	4
Avoiding infections	5
Avoiding injury	5
Avoiding damage to the device	6
Handling the measurement results	6
Handling the packaging material	7
3. Overview	8
3.1 Controls/Features	8
3.2 Information on device and on rating plate	8
3.3 Information on the packaging ..	9
4. Before you get started	10
4.1 Removing the locking pin	10
4.2 Removing the transport lock ..	10
4.3 Fitting the wall spacer	10
4.4 Aligning the scale	11
5. Weighing	11
5.1 Adjusting the display	11
5.2 Performing weighing	12
6. Hygienic reprocessing	12
6.1 Cleaning	12
Cleaning housing	12
Cleaning scale ring and scale ..	13
6.2 Desinfection	14
6.3 Sterilisation	14
7. Function check	14
8. What do I do if ...?	15
9. Maintenance/Recalibration	15
9.1 Information on servicing (seca 750/760/762)	15
9.2 Information on recalibration (seca 761)	16
10. Technical data	16
10.1 General technical data	16
10.2 Technical data, weighing	17
10.3 Conversion tool	18
11. Disposal	18
12. Warranty	19
13. Declaration of conformity	19

1. DEVICE DESCRIPTION

1.1 Intended use

The mechanical seca flat dial scale is mainly used in hospitals, medical practices and inpatient care facilities in accordance with national regulations.

The scale is for conventional determination of weight and establishment of general state of nutrition; it assists the physician supervising treatment in making a diagnosis or deciding on a course of treatment.

To make an accurate diagnosis, however, other specific examinations have to be ordered by the physician and their results taken into account, in addition to determining a weight value.

1.2 Functional description

With a mechanical dial scale weight is calculated via a load lever system.

Before weighing takes place, the zero point can be manually reset each time with the adjusting wheel.

Calibrated scales are supplied with a kg scale.

Uncalibrated scales are supplied with a kg, lbs, kg/lbs or a kg/sts scale depending on the model.

1.3 User qualification

The device may only be operated by healthcare professionals.

2. SAFETY INFORMATION

2.1 Safety information in this manual

**DANGER!**

Used to identify an extremely hazardous situation. If you fail to take note of this information, serious irreversible or fatal injuries will occur.

**WARNING!**

Used to identify an extremely hazardous situation. If you fail to take note of this information, serious irreversible or fatal injuries may result.

**CAUTION!**

Used to identify a hazardous situation. If you fail to take note of this information, minor to moderate injuries may result.

NOTICE!

Used to identify possible incorrect usage of the device. If you fail to take note of this information, you may damage the device, or the measured results may be incorrect.

NOTE

Includes additional information about use of the device.

2.2 Basic safety precautions

Handling the instrument

- Please take note of the information in these instructions for use.
- Keep the instructions for use in a safe place. The instructions for use are a component of the device and must be available at all times.

**CAUTION!****Patient hazard, damage to device**

- ▶ Have servicing and subsequent verification carried out regularly as described in the relevant section of this document.
- ▶ Technical modifications may not be made to the device. The device does not contain any parts for servicing by the user. Only have servicing and repairs performed by an authorized

seca service partner. You can find service partners in your area at www.seca.com or by sending an e-mail to service@seca.com.

- ▶ Only use original seca accessories and spare parts, otherwise seca will not grant any warranty.

Avoiding infections



WARNING!

Risk of infection

- ▶ Hygienically reprocess the scale regularly as described in the respective section in this document.
- ▶ Make sure that the patient has no infectious diseases.
- ▶ Make sure that the patient has no open wounds or infectious skin alterations, which may come into contact with the device.

Avoiding injury



WARNING!

Injury from falls

- ▶ Ensure that the device is positioned firmly and level.
- ▶ Support people with restricted mobility when they step onto and off the scale.
- ▶ Only use this scale for patients who are able to stand on their own when being weighed.
- ▶ Make sure that the patient does not step onto and off the weighing platform right at the edges.
- ▶ Make sure that the patient steps onto and off the weighing platform slowly and safely.



WARNING!

Danger of slipping

- ▶ Ensure that the weighing platform is dry before the patient steps onto it.
- ▶ Ensure that the patients feet are dry before he or she steps onto the weighing platform.
- ▶ Make sure that the patient steps onto and off the weighing platform slowly and safely.

Avoiding damage to the device

NOTICE!

Damage to device

- ▶ Make sure not to drop the device.
- ▶ Do not expose the device to any impact or vibration.
- ▶ Perform function controls regularly as described in the relevant section in this document. Do not operate the device if it is damaged or not working properly.
- ▶ Caustic detergents may damage the surfaces. Only use a soft cloth dampened with mild soapsuds to clean the surfaces of the device.
- ▶ Only use disinfectants suitable for sensitive surfaces. Suitable disinfectants are available from specialist dealers.

Handling the measurement results



WARNING!

Patient hazard

This device is **no** diagnostic device. It simply assists the treating physician in establishing a diagnosis.

- ▶ In order to make a precise diagnosis and initiate therapeutic measures, besides determination of the weight, further targeted examinations must be set up by the physician, and their results must be considered.
- ▶ The responsibility for diagnosis and treatment lies with the treating physician.



CAUTION!

Patient hazard

In order to avoid misinterpretations, test results for medical use must be displayed and used in SI units (weight: kilograms, length: metres) only.

- ▶ Use the results exclusively in SI units.
- ▶ The use of measurement results in non-SI units is the sole responsibility of the user.
- ▶ If your scale is unable to display SI units, you can use the conversion tool in this document.

NOTICE!

Inconsistent measuring results

- ▶ Before you save measurement values determined using this device and use them further (e.g. in seca PC software or in a hospital information system), make sure that the measurement values are plausible.
- ▶ If measurement values are transmitted to seca PC software or a hospital information system, make sure prior to further use that the measurement values are plausible and are assigned to the correct patient.

Handling the packaging material



WARNING!

Risk of suffocation

Packaging material made of plastic foil (bags) is a choking hazard.

- ▶ Keep packaging material out of reach of children.
- ▶ In the event that the original packing material may not be available anymore, only use plastic bags with security holes in order to reduce the risk of suffocation. Use recyclable materials if possible.

NOTE

Keep the original packing material for future use (e.g. returning for maintenance service).

3. OVERVIEW

3.1 Controls/Features

seca 750:

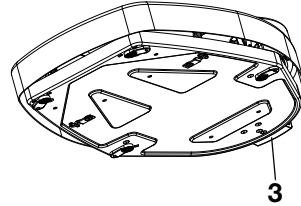
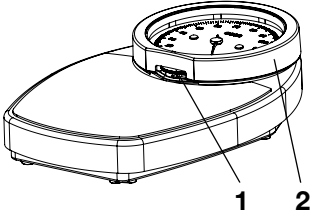



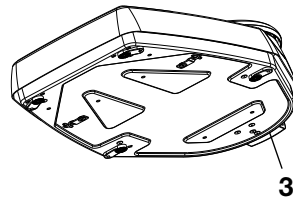
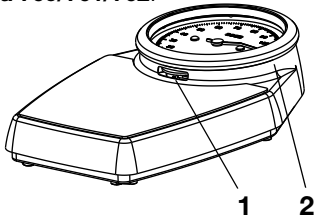

seca 760/761/762:









No.	Control/Feature	Function
1	Adjusting wheel	For adjusting the display.
2	Scale ring	<ul style="list-style-type: none"> Protects the pointer and dial Can be removed for cleaning (not seca 750)
3	Transport lock	<ul style="list-style-type: none"> Prevents any relative movement between the weighing platform and lower section of the housing during transport Can be used as a wall spacer.

3.2 Information on device and on rating plate

Text/Symbol	Meaning
Model	Model number
Ser. no.	Serial number
	Follow instructions for use
e	Value in units of measurement used to classify and calibrate a scale (calibrated models)
d	Value in units of measurement which gives the difference between two consecutive display values
	Class III scale in compliance with directive 2014/31/EU

Text/Symbol	Meaning
	<ul style="list-style-type: none"> • Unit used for scale (here: kg) • Part of scale below the minimum load: For technical reasons no meaningful measured results possible in this range
	<p>Device complies with EC standards and directives.</p> <ul style="list-style-type: none"> • M: Conformity label according to Directive 2014/31/ EU governing non-automatic weighing instruments (verified models) • 16: (Example: 2016) Year in which the declaration of conformity was completed and the CE symbol was applied (verified model) • 0102: Notified body metrology (verified models) • 0123: Notified body medical products

3.3 Information on the packaging

	Protect from moisture
	Arrows indicate top of product. Transport and store in an upright position.
	Fragile Do not throw or drop.
	Permitted min. and max. temperature for transport and storage
	Permitted min. and max. moisture for transport and storage
	Open packaging here
	Packaging material can be disposed of through recycling programs

4. BEFORE YOU GET STARTED ...

4.1 Removing the locking pin

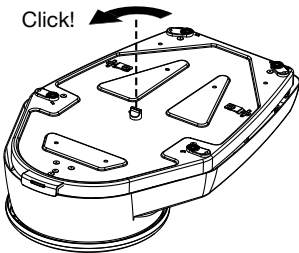

1. Turn the locking pin on the base of the housing a quarter-turn anticlockwise.

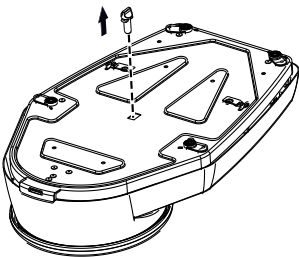

2. Take out the locking pin.

NOTE

Keep the locking pin for transporting the scale at a later date.

4.2 Removing the transport lock

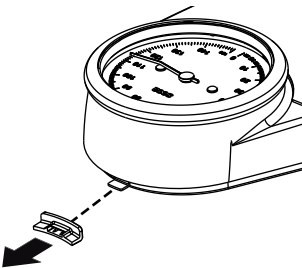

- ▶ Remove the transport lock from the lower section of the housing.

NOTE:

- ▶ Put the transport lock in a safe place for subsequent transport of the scale.
- ▶ You can use the transport lock as a wall spacer (see section “Fitting the wall spacer”).

4.3 Fitting the wall spacer

If you wish to position the scale close to a wall, we recommend using the transport lock (see section “Removing the transport lock”) as a wall spacer. This stops the weighing platform from touching the wall and the measured result from being incorrect.

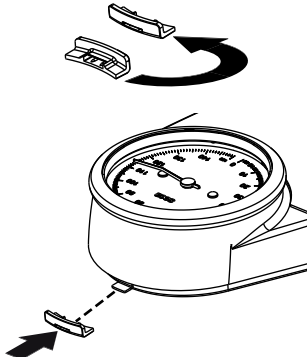

1. Position the transport lock as shown in the adjacent drawing.
2. Attach the transport lock to the lower section of the housing.

4.4 Aligning the scale

ATTENTION!

Incorrect measurement due to force shunts

Soft floor coverings such as carpets may cause weights to be measured incorrectly.

- ▶ Set the scale up so that only its feet are in contact with the floor.
- ▶ Place the scale on a firm, flat surface.

5. WEIGHING



CAUTION!

Bodily injury

Perform a function check before every use as described in the section "Function check" on page 35.

5.1 Adjusting the display

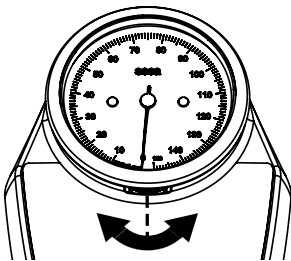

To obtain meaningful measured values you must check before every use that the pointer of the scale reads "0".

1. Ensure that the scale has no load.
2. Check the current position of the pointer.
3. Move the adjusting wheel so that the pointer reads "0".
 - Turn clockwise: Pointer moves counter-clockwise
 - Turn counter-clockwise: Pointer moves clockwise

5.2 Performing weighing

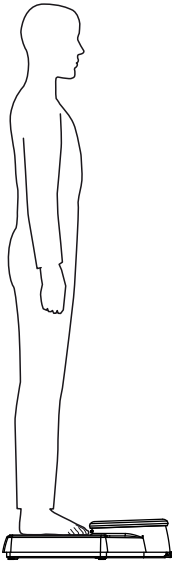

CAUTION!

Patients can be injured if they fall

People with restricted mobility may fall when trying to step on or off the scales.

- ▶ Support people with restricted mobility when they step on and off the scales.
- ▶ Only use this scale for patients who are able to stand on their own when being weighed.

1. Make sure that the pointer reads "0".
2. Ask the patient to step onto the scale and keep still.
3. Read off the measured result.

NOTE:

If your scales only display measurement values in "lbs", you can use the conversion tool on page 39 to convert measurement values to kg values.

4. Ask the patient to step off the scale.

6. HYGIENIC REPROCESSING

NOTICE!

Damage to device

Inappropriate detergents and disinfectants may damage the sensitive surfaces of the device.

- ▶ Use only disinfectants free of chlorine and alcohol which are explicitly suitable for acrylic sheet and other sensitive surfaces (active ingredient: quaternary ammonium compounds, for example).
- ▶ Do not use white spirit or petroleum spirit.
- ▶ Only use disinfectants suitable for sensitive surfaces. Suitable disinfectants are available from specialist dealers.

6.1 Cleaning

- Cleaning housing** ▶ Use a soft cloth dampened with mild soapsuds to clean the surfaces of the device.

Cleaning scale ring and scale

You can take the scale ring off the weighing platform (not **seca 750**) to clean the inside of the scale ring and the scale.

1. Turn the scale ring counter-clockwise.

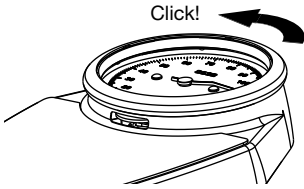

2. Take the scale ring off.

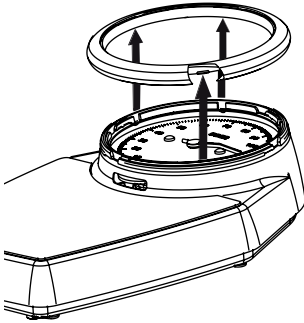

ATTENTION!

Damage to device

When the scale ring has been taken off, the pointer and scale on the device are freely accessible. If these parts are damaged, it will not be possible to obtain meaningful measured results.

- ▶ Check that the pointer and scale have not been damaged during cleaning.
3. Clean the following parts with a soft cloth dampened with a mild soapy solution:
 - Scale
 - Inside of scale ring
 4. Put the scale ring back on the housing.

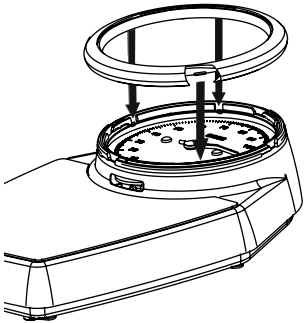

5. Turn the scale ring clockwise to resecure.

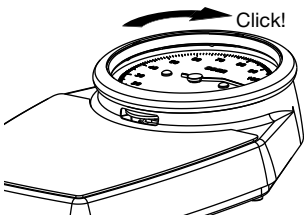

6.2 Desinfection

1. Check that your disinfectant is suitable for sensitive surfaces and acrylic sheet.
2. Follow the instructions on the disinfectant.
3. Disinfect the device at regular intervals using a soft cloth dampened with a suitable disinfectant.

Interval	Component
Prior to every measurement with direct skin contact	Weighing platform
After every measurement with direct skin contact	Weighing platform
If required	Scale ring and viewing window

6.3 Sterilisation

This device may not be sterilised.

7. FUNCTION CHECK

- ▶ Perform functional check prior to each operation.

A complete functional check includes:

- Visual inspection for mechanical damage
- Visual inspection and function check of the display elements
- Function check of all controls shown in the section “Overview”

If you find faults or deviations during the function check, first try to remedy the fault with the aid of the section “What do I do if ...?”.



CAUTION!

Bodily injury

If you find faults or deviations during the function check which you are unable to remedy with the aid of the section "What do I do if ...?", you may not use the device.

- ▶ Have the device repaired by seca service or an authorized service partner.
- ▶ You should also follow the instructions in the section "Maintenance/Recalibration" on page 36.

8. WHAT DO I DO IF ...?

Malfunction	Cause/Remedy
... the scale does not show any weight?	The device is not ready for use - Remove transport lock
... the scale does not show any plausible weight?	<ul style="list-style-type: none">• Before weighing pointer does not read "0" - Adjust display• Force shunt: scale is e.g. touching a wall or patient is supporting his/her weight against the wall. - Move scale away from wall - Use transport lock as wall spacer - Ask patient to stand on the scale unaided

9. MAINTENANCE/RECALIBRATION

9.1 Information on servicing (seca 750/760/762)

The product must be set up carefully and serviced regularly. Depending on how frequently the scale is used, we recommended servicing at intervals of 3 to 5 years.

ATTENTION!

Incorrect measurements as a result of poor servicing

- ▶ Please only have servicing and repairs performed by an authorized service partner.
- ▶ You can find service partners in your area at www.seca.com or by sending an e-mail to service@seca.com.

9.2 Information on recalibration (seca 761)

We recommend having your device serviced prior to subsequent verification.

NOTICE!

Incorrect measurements as a result of poor servicing

- ▶ Please only have servicing and repairs performed by an authorized service partner.
- ▶ You can find service partners in your area at www.seca.com or by sending an e-mail to service@seca.com.

Have an authorized technician perform subsequent verification according to national legal regulations.

Subsequent verification is necessary whenever one or more verification seals are damaged.

10. TECHNICAL DATA

10.1 General technical data

General technical data	
Dimensions seca 750 <ul style="list-style-type: none"> • Depth • Width • Height 	477 mm 317 mm 117 mm
Net weight seca 750	approx. 3.5 kg
Dimensions seca 760/761 <ul style="list-style-type: none"> • Depth • Width • Height 	470 mm 303 mm 118 mm
Dimensions seca 762 <ul style="list-style-type: none"> • Depth • Width • Height 	470 mm 303 mm 118 mm
Net weight seca 760/761/762	approx. 3.5 kg
Temperature range <ul style="list-style-type: none"> • Operation • Storage • Transport 	+10 °C to +40 °C (50 °F to 104 °F) -10 °C to +65 °C (14 °F to 149 °F) -10 °C to +65 °C (14 °F to 149 °F)

General technical data	
Air pressure • Operation • Storage • Transport	700 - 1060 hPa 700 - 1060 hPa 700 - 1060 hPa
Humidity • Operation • Storage • Transport	30 % - 80 % no condensation 0 % - 95 % no condensation 0 % - 95 % no condensation
Medical device in accordance with Directive 93/42/EEC	Class I with measuring function

10.2 Technical data, weighing

Technical data, weighing seca 761	
Calibration in accordance with Directive 2014/31/EU	Class IIII
Maximum load	150 kg
Minimum load	10 kg
Graduations	1 kg
Zero adjustment range	20 kg
Accuracy on initial calibration: • 10 kg to 50 kg • 50 kg to 150 kg	± 0.5 kg ± 1 kg

Technical data, weighing seca 750/760/762	
Maximum load	150 kg / 320 lbs / 23 sts
Minimum load	10 kg / 20 lbs / 1 sts
Graduations seca 750/760	1 kg / 1 lbs / 1 lbs
Graduations seca 762	0,5 kg / 1 lbs / 1 lbs
Zero adjustment range	20 kg / 45 lbs / 3 sts
Accuracy: • 10 kg to 80 kg • 80 kg to 150 kg • 20 lbs to 180 lbs • 180 lbs to 320 lbs • 1 sts to 12 sts • 12 sts to 23 sts	± 1 kg ± 1.25 % ± 2.2 lbs ± 1.25 % ± 0.2 sts ± 1.25 %

10.3 Conversion tool

Some models display measurement values only in "lbs". For these models, use the conversion tool below to convert measurement values to kg values.

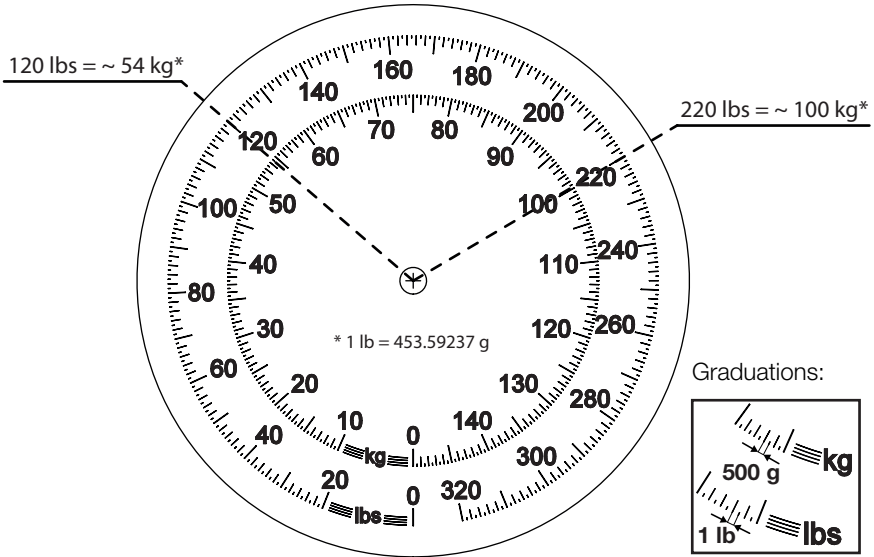

11. DISPOSAL

This device consists of high-quality raw materials which can be recycled. Dispose of the device in accordance with the local laws and regulations applicable in your country.

12. WARRANTY

We offer a two-year warranty from the date of delivery for defects attributable to faulty material or poor workmanship. This excludes all moveable parts such as (rechargeable) batteries, cables, power supply units, etc. Defects which are covered by the warranty shall be rectified free of charge for customers on production of the sales receipt. No further claims can be accepted. The costs of shipment in both directions shall be borne by the customer where the device is not located at the customer's premises. In the event of any damage during shipment warranty claims can only be asserted where the complete original packaging was used for shipment and the scales were secured inside in the same manner as in the original packaging. You should therefore keep all packaging.

The warranty shall become null and void where the device is opened by persons not expressly authorised to do so by seca.

We ask customers based abroad to contact their local sales agent directly in the case of warranty claims.

13. DECLARATION OF CONFORMITY

seca gmbh & co. kg hereby declares that the product meets the terms of the applicable European directives. The unabridged declaration of conformity can be found at: www.seca.com.

Medical Measuring Systems and Scales since 1840

seca gmbh & co. kg
Hammer Steindamm 3–25
22089 Hamburg · Germany
Telephone +49 40 20 00 00 0
Fax +49 40 20 00 00 50
info@seca.com

seca operates worldwide with headquarters
in Germany and branches in:

seca france
seca united kingdom
seca north america
seca schweiz
seca zhong guo
seca nihon
seca mexico
seca austria
seca polska
seca middle east
seca brasil
seca suomi
seca américa latina

and with exclusive partners in
more than 110 countries.

All contact data under www.seca.com

17-10-06-389-100f/04-2016G