

# seca 416

**seca**  
Precision for health

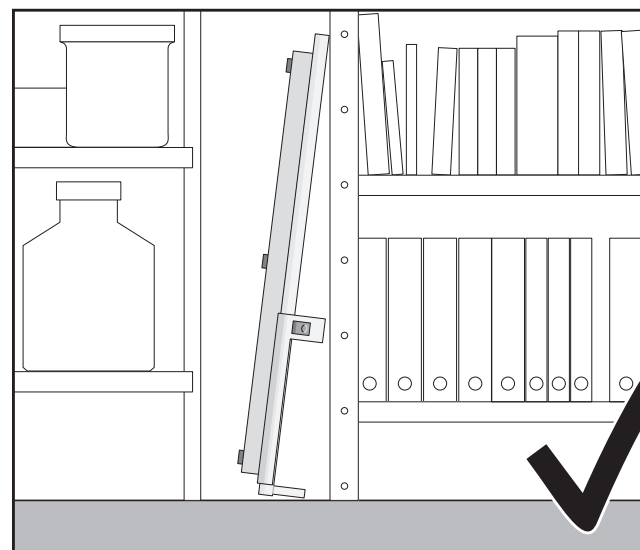
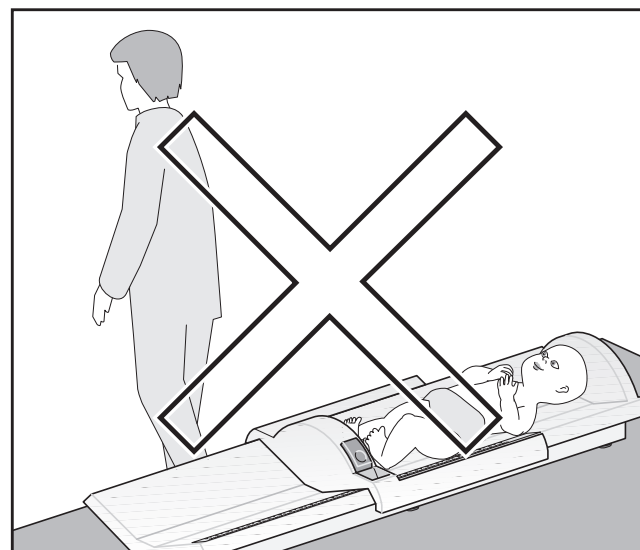
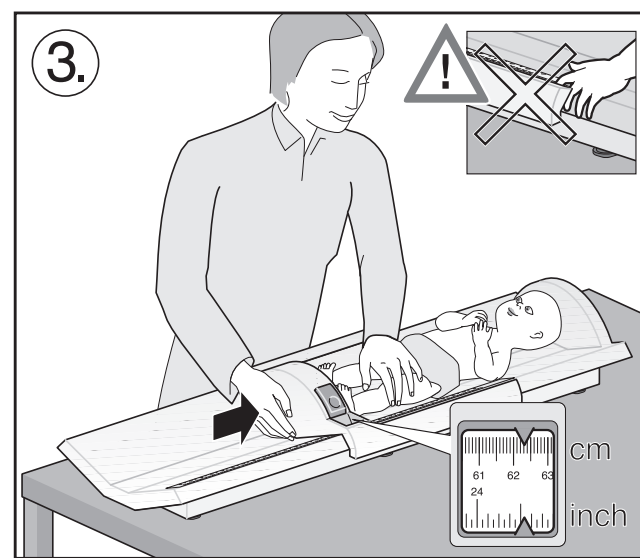
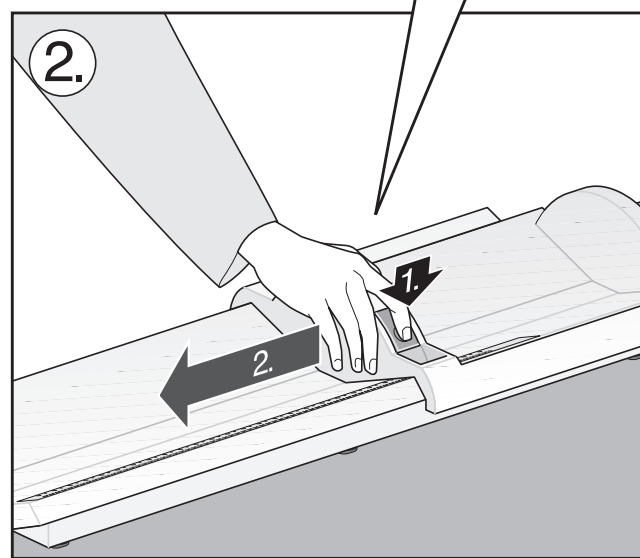
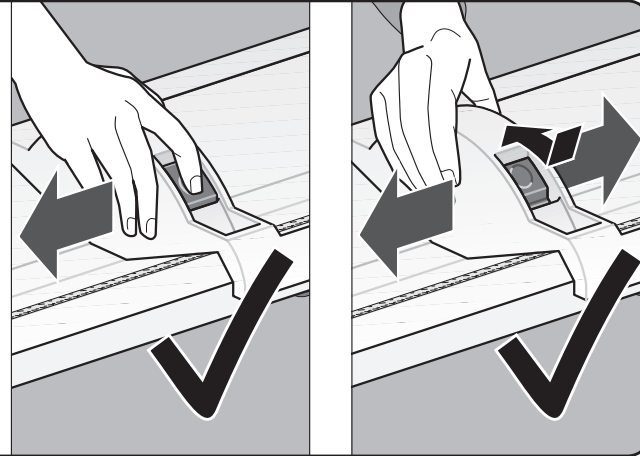
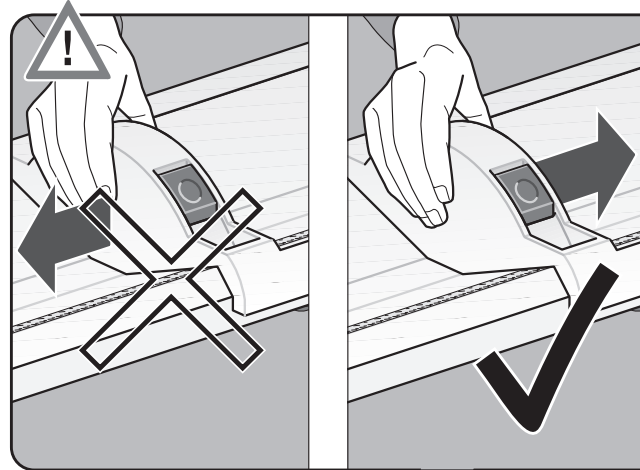
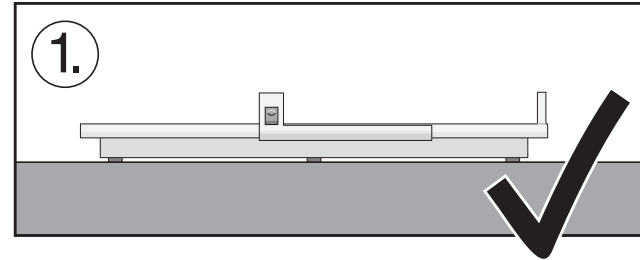
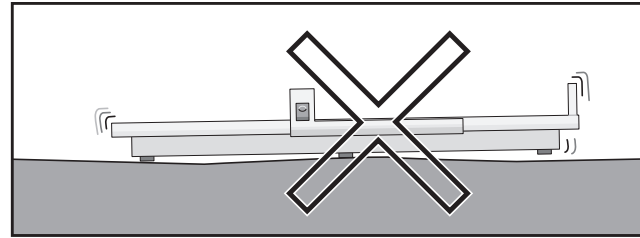

**Technische Daten/Reinigung • Technical data/Cleaning • Fiche technique/Nettoyage • Specifiche tecniche/Pulizia • Datos técnicos/Limpieza • Tekniske data/Rengøring • Tekniske data/Rengöring • Tekniske data/Rengøring • Teknisk tiedot/Puhdistus • Technische gegevens/Reiniging • Datos técnicos/Limpieza • Τεχνικά στοιχεία/Καθάρισμα**

d			a, b, c	kg		
1 mm	33 – 100 cm ±2 mm	+10°C ... +40°C	a = 402 mm	3,2 kg		
1/16 inch	13 – 39 inch ±1/8 inch		b = 1105 mm			
			c = 165 mm			

## GB - Warranty

A two-year warranty from date of delivery applies to defects attributable to poor materials or workmanship. All moveable parts - batteries, cables, mains units, rechargeable batteries etc. - are excluded. Defects which come under warranty will be made good for the customer at no charge on production of the receipt. No further claims can be entertained. The costs of transport in both directions will be borne by the customer should the equipment be located anywhere other than the customer's premises. In the event of transport damage, claims under warranty can be honoured only if the complete original packaging was used for any transport and the merchandise secured and attached in that packaging just as it was when originally packed. All the packaging should therefore be retained. A claim under warranty will not be honoured if the equipment is opened by persons not expressly authorised by seca to do so. We would ask our customers abroad to contact their local sales agent in the event of a warranty matter.



## GB Declaration of conformity

seca gmbh & co. kg hereby declares that the product meets the terms of the applicable European directives. The unabridged declaration of conformity can be found at: [www.seca.com](http://www.seca.com).

Medical Measuring  
Systems and Scales  
since 1840

seca gmbh & co. kg  
Hammer Steindamm 3-25  
22089 Hamburg • Germany

Telephone +49 40 20 00 00 0

Fax +49 40 20 00 00 50

info@seca.com

All contact data under [www.seca.com](http://www.seca.com)

**seca**  
group

seca deutschland    seca nihon    seca suomi  
seca france    seca mexico    seca américa latina  
seca united kingdom    seca austria    seca asia pacific  
seca north america    seca polska  
seca schweiz    seca middle east  
seca zhong guo    seca brasil