

LETTINI VISITA
EXAMINATION COUCHES
LITS D'EXAMEN
CAMILLAS DE VISITA
MARQUESAS PARA VISITA
UNTERSUCHUNGSBETTEN
BESÖKSSÄNGEN

- È necessario segnalare qualsiasi incidente grave verificatosi in relazione al dispositivo medico da noi fornito al fabbricante e all'autorità competente dello Stato membro in cui si ha sede.
- All serious accidents concerning the medical device supplied by us must be reported to the manufacturer and competent authority of the member state where your registered office is located.
- Il est nécessaire de signaler tout accident grave survenu et lié au dispositif médical que nous avons livré au fabricant et à l'autorité compétente de l'état membre où on a le siège social.
- Es necesario informar al fabricante y a la autoridad competente del Estado miembro en el que se encuentra la sede sobre cualquier incidente grave que haya ocurrido en relación con el producto sanitario que le hemos suministrado.
- É necessário notificar ao fabricante e às autoridades competentes do Estado-membro onde ele está sediado qualquer acidente grave verificado em relação ao dispositivo médico fornecido por nós.
- Jeder schwere Unfall im Zusammenhang mit dem von uns gelieferten medizinischen Gerät muss unbedingt dem Hersteller und der zuständigen Behörde des Mitgliedsstaats, in dem das Gerät verwendet wird, gemeldet werden.
- Det är nödvändigt att meddela tillverkaren och de behöriga myndigheterna i den berörda medlemsstaten, om alla allvarliga olyckor som inträffat i samband med den medicintekniska utrustning som levererats av oss.



27401 - 27402 - 27444



Gima S.p.A.
Via Marconi, 1 - 20060 Gessate (MI) Italy
gima@gimaitaly.com - export@gimaitaly.com
www.gimaitaly.com
Made in Italy



INTRODUCTION

In accord with Regulation (EU) 2017/745, this product is part of the CLASS I MEDICAL DEVICES. You should carefully read this manual before using this medical device.

DESCRIPTION

The examination couch is small in size, particularly suitable for medical practices / surgeries. The mattress, washable and fireproof, is composed of two parts, a first part fixed, a second part reclining in different positions. Depending on the model, the structure can be painted or chromed. On request: sheet holder.

COMPONENTS:	Sacchetto con materiale di montaggio:
<ul style="list-style-type: none"> • n.2 Legs • n.1 Crosspiece with backrest ▲ • n.5 Crosspieces ☆ • Back padding • Seat padding 	<ul style="list-style-type: none"> • n.14 SCREWS TBE 8x50 • n. 16 WASHERS M8 • n. 6 CHIPBOARD SCREWS TPS 4,5x45 (to fix the mat to the frame) • Allen key 5 mm

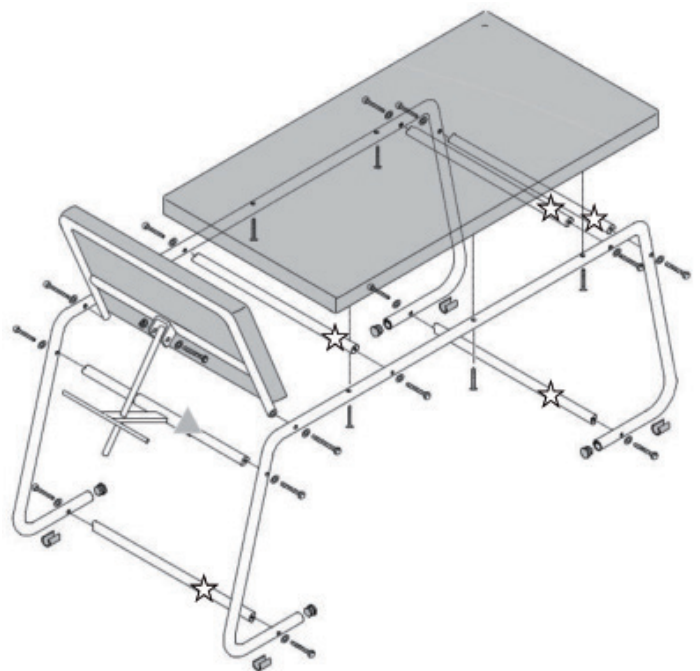

The couch is completely disassembled.

Follow the assembly procedures shown on the drawing.

1. Take the legs of the couch and assemble them with the 5 crossbeams using the screws and washers.
2. Fix the crosspiece to the structure with the head support rod already mounted to the padding of the backrest using an hexagonal screw and his nut.
3. Finally fix the pads to the frame using screws.

ASSEMBLY INSTRUCTIONS

TECHNICAL DATA

Measurement	cm.193 x 62 x h73 * box 173x16x74h
Weight	26,4 kg (29,5 kg with box)
Max capacity	120 kg

* The paddings are not assembled by manufacturer but must be positioned during assembly by purchaser/user. Consequently, the overall dimensions measurements may differ slightly from those given in the data sheet.

WARNINGS!

- Check the locking nuts are tightened.
- Observe the maximum flow rates indicated in the data sheets.
- Avoid direct contact with open wounds.
- Not for use in open environments.
- When adjusting the height of the couch and the back, make sure that no one inserts hands, legs or anything into the movement area: CRUSHING RISK!
- Move the bed without lifting it from the floor.











- Before moving the bed, unlock the wheels.

MAINTENANCE AND CLEANING

- Use only original spare parts.
- Periodically check all fixing points.
- To preserve at best, it is recommended to avoid prolonged exposure to sunlight, to contact and deposit in saline and very humid environments.
- Wash the stainless steel surfaces with soapy water and use appropriate disinfectants.
- Rinse with a damp cloth and dry thoroughly.
- Do not spill on the surface cleaners containing chlorine or ammonia, fatty and oily substances.
- Do not use cleaning utensils containing iron. If necessary disinfection only use suitable non- corrosive products.

Cleaning rules for coating:

Clean with damp soapy cloth and rinse well with clean water. Do not use solvents, bleaches, synthetic detergents, polishes or aerosol spray. **Attention:** Normally synthetic leather light colours should not come in contact with no fixed cloured clothes (such as jeans and similar) not to cause stains and rings that cannot be cleaned up.

	Keep away from sunlight		Medical Device compliant with Regulation (EU) 2017/745		Keep in a cool, dry place
	Product code		Consult instructions for use		Manufacturer
	Date of manufacture		Lot number		Medical Device
	Caution: read instructions (warnings) carefully		Unique device identifier		

GIMA WARRANTY TERMS

The Gima 12-month standard B2B warranty applies.