

UnionTher

LH1XX rev.001

Treatment and examination couches for use in physical therapy
Letini da visita e manipolazioni per terapia fisica

USE AND MAINTENANCE MANUAL / MANUALE D'USO E MANUTENZIONE



ENGLISH VERSION..... 4

1 GENERAL INFORMATIONS..... 4

1.1 PURPOSE, CONTENT AND TARGET AUDIENCE..... 4

1.2 MANUFACTURER 4

1.3 INTENDED USE AND EQUIPMENT DESCRIPTION 4

1.4 APPLICATION ENVIRONMENT 4

1.5 PRODUCTS INSIGHTS 4

1.6 STORAGE 4

1.7 SYMBOLS..... 4

2 SPECIAL WARNINGS AND USE RESTRICTIONS..... 5

2.1 COLLATERAL EFFECTS AND CONTRAINDICATIONS 6

3 CONFIGURATED ITEM CODE 6

4 USE..... 6

4.1 UNPACKING 6

4.2 STARTING 6

4.3 HEIGHT ADJUSTMENT 7

4.3.1 Configuration A (electric with foot switch). 7

4.3.2 Configuration B (electric, with foot rail)..... 7

4.3.3 Configuration C (hydraulic, pedal-operated). 7

4.3.4 Configuration D (electric with hand control) 7

4.3.5 Configurartion G (ergonomic control multi-purpose)..... 7

4.4 EQUIPMENT 7

4.4.1 With wheel kit 7

4.5 ADJUSTING THE COUCH PANEL SECTIONS 7

5 MAINTENANCE..... 9

5.1 ROUTINE MAINTENANCE 9

5.2 NON ROUTINE MAINTENANCE..... 9

5.3 SPARE PARTS 9

6 TROUBLESHOOTING 10

7 CLEANING AND DISINFECTION 11

7.1 WASHING..... 11

7.2 DISINFECTION 11

7.2.1 Surface disinfection 11

8 REUSE OF THE PRODUCT 11

9 TECHNICAL SHEET 12

10 ELECTRIC DIAGRAM..... 13

11 RELATED ITEMS AND ACCESSORIES..... 13

12 WARRANTY 15

13 DISPOSAL OF WASTE ELECTRICAL OR ELECTRONIC EQUIPMENT AND PACKAGING 15

14 MAINTENANCE RECORD SHEET 16

ENGLISH VERSION

1 GENERAL INFORMATIONS

1.1 Purpose, content and target audience

This manual is intended to provide the necessary information to permit a proper use of the equipment and to be able to use it independently and safely.

This manual contains information relating to the technical, operation, maintenance, spare parts and safety. This book is also intended to technicians in charge of maintenance equipment.

This Instruction Booklet should always follow the equipment and must be carefully preserved in order not to compromise its readability.

In case of transfer to third parties this manual has to be transmitted with other documents as required by European Directive 93/42 EEC.

1.2 Manufacturer

CHINESPORT S.P.A, Via Croazia, 2-33100 Udine - Italy

tel. +39 0432621621–fax+39 0432621620 – website: www.chinesport.com.

The company produces according a quality system by standard UNI EN ISO 13485:2012.

1.3 Intended use and equipment description

Tables for use in static therapy for supine standing by gradually tilting the board. Movement assisted by a low voltage electric motor or gas springs, depending on the version chosen.

The equipment comes complete with padded board, postural adjustments and accessories for patient comfort and support. All models are easy to handle thanks to the swivel wheels, full brake and directional lock provided for rectilinear movements.

1.4 Application Environment

Medical devices covered by this manual are in conformity according to attached VII of the directive 93/42/EEC amended by 2007/47/CE

In particular according to UNI CEI EN 60601-2-52:

ENVIRONMENT OF APPLICATION 5 - outpatient care administered in a hospital or other medical center under medical supervision, in which the EM devices are provided for the needs of sick people who have suffered injuries or are carriers of disability, for the treatment, diagnosis and monitoring.

1.5 Products insights

Further documentation can be found on our website www.chinesport.com.

Specially, you can reading the QR code on the cover of this manual to quickly connect to the website.

Where provided QR code can also be found on the product.

You can download declaration of conformity and other product documents in their latest version and in color format directly from website.



1.6 Storage

The following environmental conditions must be ensured when the equipment is to be stored:





1. relative humidity 10% / 90 %;
2. temperature -10°C / +50°C.

1.7 Symbols

The symbols found in this manual and on the machine are used to draw the user's attention to important safety warnings and useful information. Observe all warning, caution and danger messages.

	<p>WARNING This symbol identifies operating/maintenance instructions or procedures which, if not observed, could result in injury or danger to the user.</p>
	<p>ELECTRIC SHOCK HAZARD This symbol identifies operating/maintenance instructions or procedures which, if not observed, could result in a risk of electric shock.</p>
	<p>CAUTION This symbol is used to warn the user that not to observe a certain operating or maintenance procedure, general rule or condition, could result in damage to the equipment.</p>

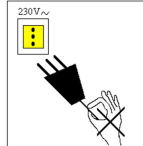
2 SPECIAL WARNINGS AND USE RESTRICTIONS

	<p>This equipment must not be used:</p> <ul style="list-style-type: none"> • By inadequately trained operators. • When having been tampered with and/or if the original product has undergone changes. • On unstable and/or uneven surfaces (e.g.: stairway, steps, etc.). • With a patient inadequately secured to the supporting straps and footboards. • With loads greater than those declared to be safe by the manufacturer. • In an improper configuration or when it is thought to be harmful for the patient. • In association with other devices that may interfere with the equipment. • In an explosive and/or corrosive atmosphere or exposed weather conditions. <p>In addition:</p> <ul style="list-style-type: none"> • Keep body parts away from moving parts and/or adjustments. These areas are marked by labels. • Three, four or more people are required to carry the equipment. • Set the bed in its lower and horizontal position when it is not supervised.
	<ul style="list-style-type: none"> • Do not connect to an electric system that does not comply with the current safety regulations. • Do not spill liquids on the product. • Disconnect power supply before moving and carrying out any service on the equipment circuits. • Do not damage electrical cables: preventing crushing; not disconnect the connections pulling on the cable directly, etc. 
	<ul style="list-style-type: none"> • Do not use the lifting system continuously, comply with the duty-cycle indicated in chapter "Technical sheet". • The foam rubber and plastic parts of the equipment can catch fire if brought into contact with naked flames. • The retractable wheels can be used to move the couch without any added weight. • Radiating therapy lamps can damage the upholstery. • Corrosive and/or abrasive detergents can damage the upholstery. • Make sure that the patient cannot accidentally operate the controls. • Make sure that during equipment operation any moving parts do not knock against adjacent masses. • Keep a proper distance from moving mechanical parts. • Before operating the release levers of the sections, make sure their weight can be supported. • Do not let the equipment come in touch with open flames. • Protect the padding in treatments involving heat sources. • Periodically disinfect the table's leatherette. • Record any significant safety-related intervention/defect/damage in the attached form.

	<ul style="list-style-type: none"> For operations not covered in the maintenance list, please contact Chinesport Service Centre. Only the manufacturer can repair the actuators, gearcases, controls and battery chargers, which on no account must be opened or tampered with. Otherwise the manufacturer will be no longer responsible for the equipment, whose warranty will cease to be valid. When safety is clearly in danger, immediately switch off the equipment and do not use it until the danger has been eliminated.
---	--

2.1 Collateral effects and contraindications

There is no collateral effects or contraindications during proper use, is recommended knowledge of this instruction manual.

3 CONFIGURATED ITEM CODE

Product code		L	H	1	*	*	*	*	*	*
Variable code position		1	2	3	4	5	6	7	8	9
Position	Meaning variable code	Possible values								
1-2-3		Fixed value								
4-5	SECTIONS TYPE	11 – 2 sections of which 1 is movable – Ther 1 21 - 2 sections of which 1 is movable with armrests – Ther 1 Plus 12 - 3 sections of which 2 are movable – Ther 2 22 – 3 sections of which 2 are movable (1 with armrests) – Ther 2 Plus 13 – 3 sections of which 2 are movable (section with caudal narrowing) – Ther NAR 23 – 3 sections of which 2 are movable (1 with armrests and section with caudal narrowing) – Ther Plus NAR 14 – 4 sections of which 3 are movable – Ther Flexion 24 – 4 sections of which 3 are movable (1 with armrests) – Ther Plus Flexion 18 – 3 sections of which 2 are movable – with holder thighs – Ther Gyn 17 – 3 sections of which 3 are movable – Ther Modular 27 – 3 sections of which 3 are movable (1 with armrests) – Ther Plus Modular 09 – 1 single section – Ther Osteo D 35 – 2 sections of which 1 is movable – Ther Osteo 26 – 2 sections of which 1 is movable – 2 pair of arms – Ther Plus Global								
6	ADJUSTMENT HEGHT TYPE	A Electric adjustment with foot pedal B Electric adjustment with perimeter bar C Hydraulic adjustment D Electric with hand control G Ergonomic command multi-purpose								
7	OPTIONS	1 Model without options 2 Model with wheel kit								
8-9	TYPE AND COLOR COATING	REFERENCE TO CATALOGUE								

4 USE

4.1 Unpacking

The product is consigned already assembled. And then simply remove it from the package and proceed as provided in the following paragraphs.

4.2 Starting

The bed is delivered packaged to protect it from possible damage that may occur during transport. Never use cutters to open box to prevent padding damages

After unpacking, remove the protective packaging materials. See chapter “Disposal of waste electrical or electronic equipment and packaging” for disposal instructions.

The carrier and the supplier must be immediately notified of any damage that may have occurred during transport. Damaged equipment cannot be used.

4.3 Height adjustment

Depending on the configuration chosen, the couch may have the following types of up-down controls.

4.3.1 Configuration A (electric with foot switch).

To raise the couch, press your foot on the side of the foot switch marked by the “up” arrow. Release at desired height. To lower, press the other side.

4.3.2 Configuration B (electric, with foot rail).

Using your foot, press one of the lateral rails to raise; release at desired height. To lower, lift one of the lateral rails.

4.3.3 Configuration C (hydraulic, pedal-operated).

Press either of the two pedals to pump and raise the couch up to desired height; to lower, lift the pedal with the back of your foot.

4.3.4 Configuration D (electric with hand control)

Press the button with the arrow pointing upwards to climb and the button with the arrow pointing down to get down.

4.3.5 Configurartion G (ergonomic control multi-purpose)

Press your foot or hand at + to increase the height or - to decrease.



4.4 Equipment

4.4.1 With wheel kit

To lower the retractable wheels, push the device's lower **PEDAL** all the way to the stop with the sole of your foot. To raise the wheels, lift the upper bar on the pedal with the upper side of your foot. The retractable wheels allow the couch to be moved, only without any additional load.

⚠ WARNING ⚠



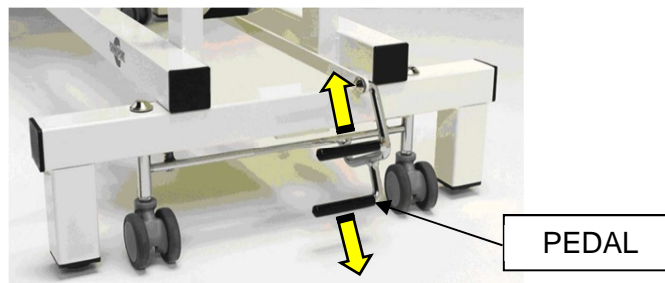

WHILE MAKING UP/DOWN ADJUSTMENT, PREVENT PANELS FROM TOUCHING THE FLOOR OR ADJACENT OBSTACLES



4.5 Adjusting the couch panel sections

You can adjust the sections of the headboard, footboard / backrest, foot flexion, foot trend. For adjustment of the specific command press the lever of the gas spring and adjust the section in the desired angle; release the lever to maintain the position. Loosen the knob that adjusts the position of the arm; tighten the knob to the desired position.

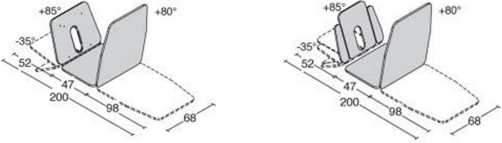
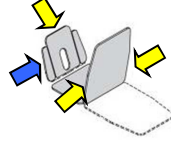
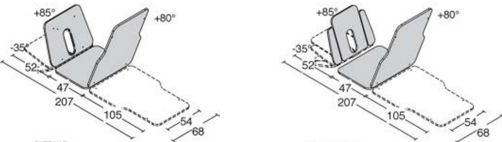
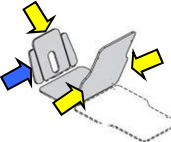
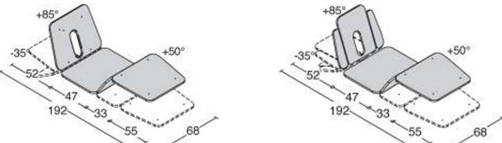
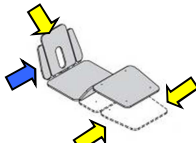
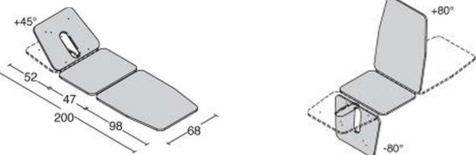
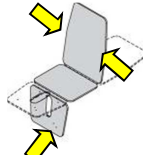
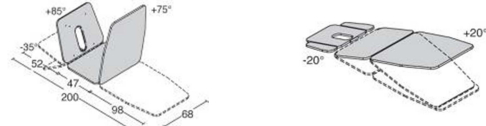
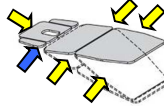
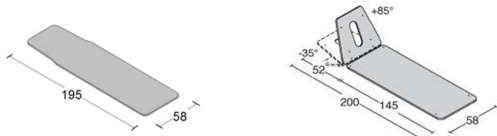
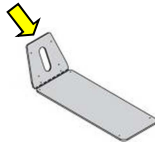
MODELS	DIMENSIONS OF INDIVIDUAL PANELS AND POSTURES	ADJUSTMENT ACTIVATION GAS SPRING CONTROL LEVER ARMREST ADJUSTMENT HANDWHEEL	OTHER DEVICES
LH111 LH121			

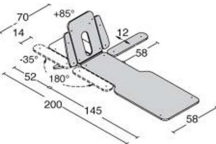
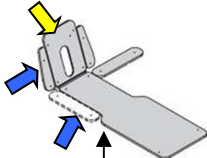
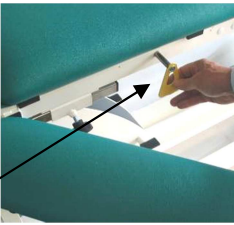
MODELS	DIMENSIONS OF INDIVIDUAL PANELS AND POSTURES	ADJUSTMENT ACTIVATION  GAS SPRING CONTROL LEVER  ARMREST ADJUSTMENT HANDWHEEL	OTHER DEVICES
LH112 LH122			
LH113 LH123			
LH114 LH124			
LH118			
LH117 LH127			
LH109 LH135			<p>AC0019 FRONT ARM-REST</p> 
LH126	 <p>Side arm-rests supplied: Can gradually rotate 180° and shift 12 cm lengthwise, adjustable by means of a locking handwheel. When the armrest is brought close to the couch, it can be fixed in position to provide a wider foot panel: pull the RETENTION HANDLE all the way out, lift the armrest slightly, and hook it to the device.</p>	 <p>RETENTION HANDLE</p>	

 **WARNING** 
 IT IS ESSENTIAL TO INSERT THE LOCKING HANDLE TO ENSURE THE ARMREST CAN BEAR WEIGHTS

⚠ WARNING ⚠

- DO NOT SIT AND DO NOT CONCENTRATE LOAD ON THE COUCH TERMINAL ENDS
- MAKE SURE TO SUPPORT THE ENTIRE LOAD AS YOU OPERATE THE ADJUSTMENT LEVERS WHILE THE PATIENT IS ON THE COUCH
- MOVEMENT OF THE ADJUSTABLE SECTIONS CAN CAUSE PINCHING IN THE VICINITY OF THE HINGES

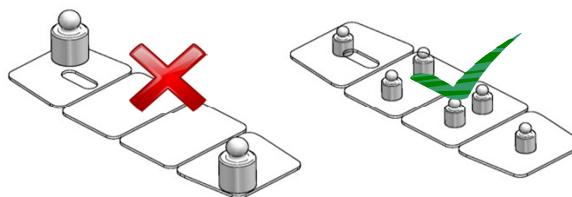

5 MAINTENANCE

Only qualified personnel may carry out maintenance on the equipment. Technicians must be familiar with the model, use and maintenance of the equipment.

Check the equipment whenever it has undergone a "rough treatment" (e.g.: fall, liquid spill, etc.) and whenever any doubts arise concerning its safety.

5.1 Routine maintenance

Routine maintenance must be carried out at least once every 12 months, following the table below:

⚠ WARNING ⚠

- WHEN SAFETY IS AT RISK, IMMEDIATELY TURN OFF THE EQUIPMENT AND DO NOT USE IT UNTIL THE DANGER HAS BEEN ELIMINATED
- ANY SIGNIFICANT WORK CARRIED OUT TO ENSURE THE COUCH IS SAFE FOR USE MUST BE RECORDED IN THE RELEVANT FORM (ATTACHED)

FREQUENCY	OPERATION
yearly	General clean of the equipment
	Visual and functional inspection of the equipment
	Frame and mechanical parts: check screws and bolts to ensure they are tight; pin and bushing clearance; check for any damage or deformation
	Check that the adjustable sections are stable and do not collapse when the control lever is released
	Check spring control cables and respective sheaths
	Check the wheels are firmly secured and free to rotate; clean the tread
	Check control box, actuators and controls to see if connectors are fully plugged in (electric versions)
	Check insulation o electrical cables for damage (electric versions)
Make sure that during electric operation no unusual vibrations or sounds are produced that may signal defects in the actuators and/ or mechanisms.	
AFTER THE ABOVE OPERATIONS, COMPLETE INSPECTION BY CARRYING OUT A FULL LIFTING CYCLE USING THE MAXIMUM SAFETY WORKING LOAD.	

⚠ WARNING ⚠

- FOR OPERATIONS NOT COVERED IN THE MAINTENANCE LIST, PLEASE CONTACT CHINESPORT SERVICE CENTRE
- ONLY THE MANUFACTURER CAN REPAIR THE ACTUATORS, GEARCASES, CONTROLS AND BATTERY CHARGERS, WHICH ON NO ACCOUNT MUST BE OPENED OR TAMPERED WITH. OTHERWISE THE MANUFACTURER WILL BE NO LONGER RESPONSIBLE FOR THE EQUIPMENT, WHOSE WARRANTY WILL CEASE TO BE VALID

5.2 Non routine maintenance

Contact Chinesport service for all operations not mentioned in the maintenance list.

5.3 Spare parts

Only use original spare parts. Contact CHINESPORT S.p.a. for a spare parts list.

6 TROUBLESHOOTING

The equipment has undergone heavy-duty tests; no significant breaks and/or failures were reported. If the equipment does not work, refer to the troubleshooting table below.

Problem	Cause	Solution
ELECTRICAL HEIGHT ADJUSTMENT		
Lifting does not work	Connectors not connected or not fully inserted	Check connections
	Overload	Do not exceed maximum load
	Power supply not available.	Check connection to mains power
	Main fuse burned out	Contact the assistance centre
	Lift actuator, control or control box is broken	Contact the assistance centre
HYDRAULIC HEIGHT ADJUSTMENT - ADJUSTMENT OF SECTIONS		
Lifting does not work	Hydraulic piston faulty.	Contact our service department.
The section adjustment does not work	Gas spring faulty or incorrectly set.	Contact our service department.
	Transmission cable interrupted.	

In case of troubleshooting table not solve your fail, you can open a service ticket means website www.chinesport.com customer service section.

ATTENTION:

Before calling our technical support, be sure to have your **SERIAL NUMBER** or the “Codice” and “Articolo” to hand: you can find it on the product label located on the equipment (as shown in the facsimile above); or the transport document / invoice number. This identification number helps reduce waiting times and improves service quality.

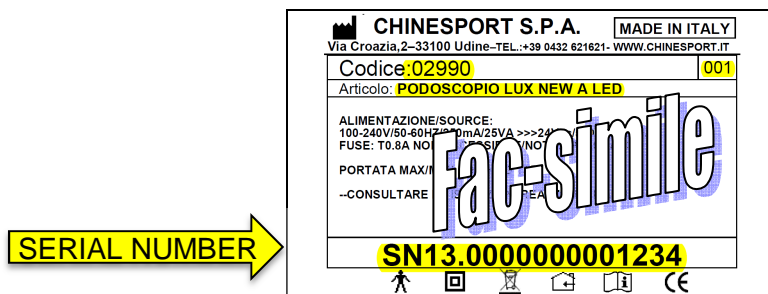

NOTE:

The equipment in need of repair at Chinesport premises must carry the “AUTHORIZATION NUMBER” on the package. This identification number, to be required from the Technical Assistance Service, helps reduce waiting times and improves service quality. Alternatively, you can contact the technical support by email (assistenza@chinesport.it), for users without internet connection it’s possible to send a fax (0432 621 698) or phone (0432 621 699), but the timing of response could be longer.

7 CLEANING AND DISINFECTION

Electrical equipment must be disconnected from mains power before cleaning.

Sky is the flame retardant fabric made for residential and contract upholstery. Its resistant structure and the easy cleaning make sky particularly suitable for hospitals, nursing homes, spas, rehabilitation centers and gyms. Sky has a leather-effect surface with a brilliant finishing, in a wide range of colors all available on stock. Sky contains Vinyzene, an anti-microbial agent added in the first steps of production process. This creates a defensive barrier against mites, bacteria and fungus, avoiding smells and allergies.

7.1 Washing

Dust gently and in case of light stains pass the surface with a damp cloth or a neutral detergent, rinse with water without squeezing. Let the fabric dry avoiding direct exposure to the sunlight. The following instructions are recommended for small located and more obstinate stains (oil, fat, cosmetics, ink, coffee, liquor, chewing-gum etc.): dissolve immediately with clear ethylic alcohol diluted in water to 20%, dab and then treat with a neutral detergent solution. Rinse abundantly.



7.2 Disinfection

7.2.1 Surface disinfection

For the disinfection of surfaces such as chassis, sky, hand control, etc. we recommend the use of disinfectants such as AMUCHINA® 10% or equivalent disinfectant with sodium hypochlorite 0.1% at the following spectrum of action:

- bactericidal in the presence of interfering substances according to EN 1276:1997;
- fungicide in the presence of interfering substances according to EN 1650:1997;
- bactericidal test according EN 13697:2001;
- fungicide test according EN 13697:2001;
- active on Salmonella typhimurium according EN 13697:2001;
- active on HIV, HAV - HBV, HCV;
- virucidal according EN14476:2005;
- virucidal influenza H1N1 according EN14476:2005.

Before use is recommended to read specific flyer.



WARNING

- REGULARLY DISINFECT THE SYNTHETIC LEATHER AND USE DISPOSABLE PAPER ROLL TO KEEP THE COUCH CLEAN
- AGGRESSIVE PRODUCTS CAN DAMAGE SURFACES
- BEFORE USING THE EQUIPMENT CHECK THAT ALL COMPONENTS ARE COMPLETELY DRY
- TO AVOID PERMANENT STAINS, THE LIGHTER COLORS OF THE ARTICLE SHOULD NOT BE BROUGHT INTO CONTACT WITH TEXTILES AND CLOTHING COLORED WITH UNFIXED DYES. WE CANNOT GUARANTEE THE ABILITY TO REMOVE UNKNOWN DYES FROM LIGHT COLORED PRODUCT

8 REUSE OF THE PRODUCT

These products have been designed so as to be suitable for reuse by another user after execution of some works and the overcoming of controls for its release.

To prepare the products at re-use by another user must be done the following:

- cleaning and disinfection carefully with adequate means;
- maintenance according to the maintenance plan and control;
- granting permission for reuse, which must accompany the product.

The above transactions must be carried out by the manufacturer or authorized dealer.

9 TECHNICAL SHEET





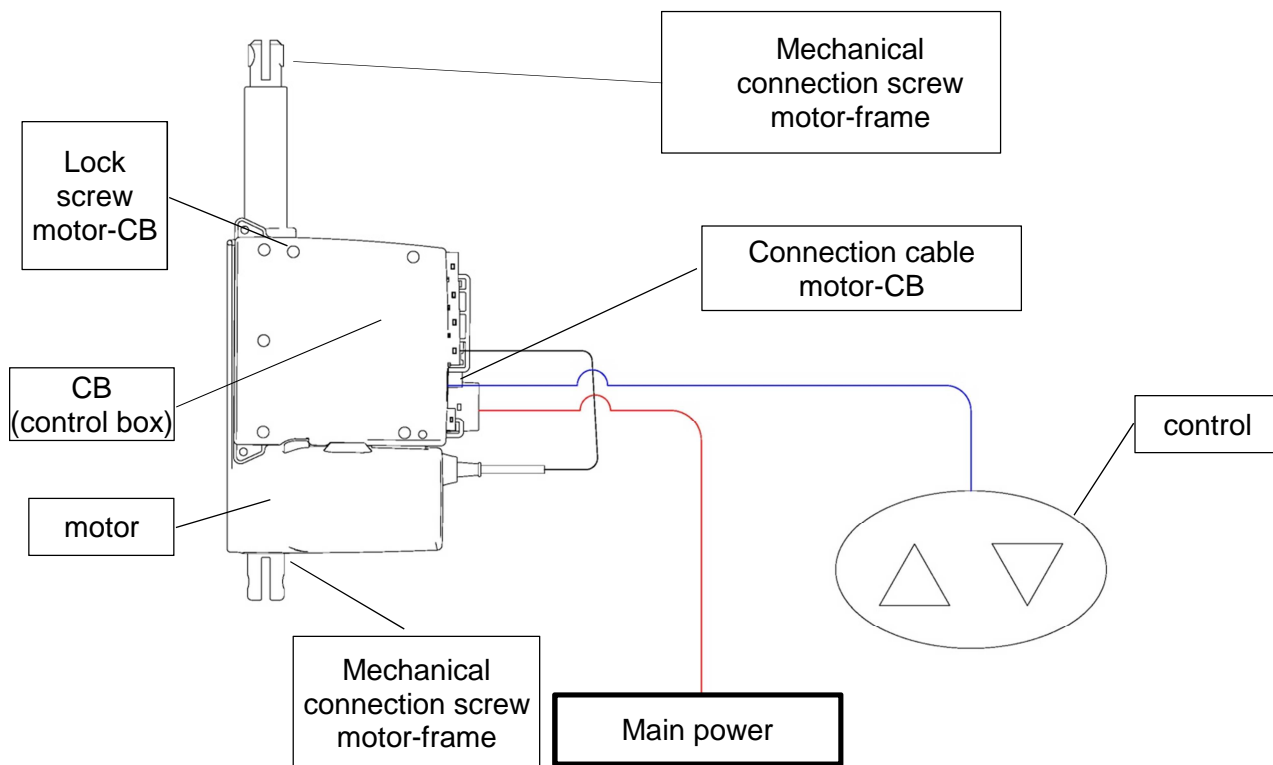

CODE	LH1xx
Safe working load (kg)	200
Max patient weight	180
Height adjustment (cm)	47 – 97
Min/max height adjustment time (sec) (electric models)	23
Work surface dimensions (cm)	207 x 68 LH113 – LH123 200 x 68 LH111 – LH112 – LH117 – LH118 – LH121 – LH122 – LH127 200 x 58 LH126 – LH135 195 x 58 LH109 192 x 68 LH114 – LH124
Electrical safety (electric models)	Class 2 - Part applied – type B
Use (electric models)	Temporary: 10% - min. USE 2 / min. PAUSE 18
Power supply (electric models)	220V 50Hz / 24V 70VA
Fuses (electric models)	Internal – not accessible
IP protection (electric models)	IP54
Equipment weight (kg)	From 76 to 83, depending on model
Adjustable sections (n°) (gas for panels – armrests, manual)	1 LH111 – LH135 2 LH112 – LH113 – LH118 3 LH114 – LH117 – LH121 4 LH122 – LH123 5 LH124 – LH126 – LH127
Upholstery fabric	Class 1IM
Padding	Foam rubber 40 mm / density 30kg/m ³ : all models except LH135 – LH126 Foam rubber 40 mm / density 50kg/m ³ : models LH135 – LH126
CND (National classification medical devices – Italy)	V0801 - LETTI PER PAZIENTI (NON ORTOPEDICI)
GMDN Code and Term	34870 - A MAINS ELECTRICITY (AC-POWERED) BED DESIGNED TO BE USED AS A GENERAL-PURPOSE PATIENT BED IN, E.G., HOSPITAL WARDS, AND WHICH IS MOTORIZED PROVIDING THE PATIENT/NURSING STAFF WITH TOUCH BUTTON ADJUSTMENT POSSIBILITIES..

10 ELECTRIC DIAGRAM



11 RELATED ITEMS AND ACCESSORIES

AC0017 – AUXILIARY BATTERY	AC0021 – AUCTION HEAD	AC0024 – CUSHION FACE
Battery to ensure the use in case of power failure	Adjustable in height, the auction head is equipped with rope and ankle	Cushion Face which allows a comfortable posture of the face
AC0031 – SHEET HOLDER	AC0032 – OVERTURNABLE SHEET HOLDER	AC0033 – VERTICAL SHEET HOLDER
Sheet holder adaptable to different roll widths	Overturnable sheet holder, with attachment to the base	Support for large rolls
AC003A – SHEET 2 VEILS	AC0035 – BIG SHEET	AC0036 – PROTECTIVE COVER

	Big sheet, roll m 0,90 x m 100	Protective cover in synthetic fabric with elasticized edges
AC0037 – ADDITIONAL FOOT SWITCH 1 ENGINE	AC0290 – PROTECTION SHEET	AC0018 – ARMS SIDE
		
Command for height adjustment from both sides	Protection sheet for cylinder heads with breathing hole	Side armrests, padded folding, which increase the lateral surface
AC0019 – TRANSVERSAL ARMREST	AC0083 – ADDITIONAL ENGINE CONTROL	AC0578 - SAFETY DEVICE + DOUBLE-SIDED TAPE
		
Accessory specific bed Osteo to allow the discharge of the arms. Removable and adjustable in two heights.	For use with hand and foot, with magnetic holder and ergonomic	Device for the complete blockage of the movement controls.

12 WARRANTY

GENERAL AFTER-SALES SERVICE CONDITIONS FOR CHINESPORT ITEMS

The warranty shall be valid for a period of 36 months from the date of delivery.

The warranty does not cover consumable items, rechargeable batteries, and generally all the material subject to wear, breakdowns caused by knocks, falls, misuse or improper use, accidental events and transport damage. This warranty shall be automatically invalidated if the equipment is tampered with. Repair of the equipment will be carried out in relation to the breakdown stated.

An estimate must be specifically requested.

Payment is cash on delivery, unless other agreements are made.

Any dispute will be dealt with solely by the Court of UDINE.

WARRANTY REPAIRS

Repairs under warranty must be specifically requested.

Repairs under warranty shall be carried out at our workshop and upon authorization, complete with the return authorization number.

The return shipment for products sent in their original package will be made free of carriage charges.

A fiscal document (bill of sale, purchase invoice or cash receipt) is required to make a warranty claim; the purchase date indicated must fall within the warranty time period.

If the product is found to be in good working order without defect, the fault-finding service shall be charged to the customer.

OUT-OF-WARRANTY REPAIRS

For out-of-warranty repairs carried out at our workshops upon authorization, transportation charges shall be paid by the customer.

The warranty of the parts replaced during the repair operations is 12 months from the moment the equipment is collected.

If the product is found to be in good working order without defect, the fault-finding service shall be charged to the customer.

REPAIRS MADE AT HOME

In the event repairs are made at the customer's home, a written request is required indicating the complete details of the person making the request, the type of machine and the breakdown.

The cost per kilometer for on-site technician visits will be agreed upon in relation to the urgency of the customer.

In the event the machine is under warranty, the customer will have to pay only the expenses incurred for the technician to reach the customer's house.

Time is calculated from the moment the technician leaves our workshop until he/she returns. The time of his/her return will be estimated based on the time required to get there.

SALE OF SPARE PARTS AND CONSUMABLE ITEMS

The orders must be in writing and specify the customer, the item and the shipping method as well as the precise fiscal data of the customer.

The order processing time can vary depending on the availability of the material.

Returned spare parts will not be accepted.

Payment will be cash on delivery, unless other agreements are made.

13 DISPOSAL OF WASTE ELECTRICAL OR ELECTRONIC EQUIPMENT AND PACKAGING

The symbol found on the equipment indicates that the waste must be "collected separately".

Therefore, the user shall take the waste to the separate waste collection points arranged by local authorities, or deliver it to the sales dealer against purchase of equivalent equipment (only in Europe). The separate collection of waste and the subsequent treatment, recovery and disposal operations promote the production of equipment using recycled materials and reduce the negative effects on the environment and health that improper waste management can cause.

Fraudulent disposal of the product will result in an administrative fine being imposed to the user by Authorities according to local Law.



