

CALDARA

FIXED FLATBED STRETCHER

INSTRUCTIONS FOR INSTALLATION,
USE AND MAINTENANCE

OW3XL



INDEX:

- EC declaration of conformity	1
- Warranty certificate.	2
- General provisions	3
<i>Presentation of the manual</i>	
<i>Customer support service</i>	
<i>Conventions</i>	
- Safety	4
<i>General provisions</i>	
- Introduction	5
<i>Technical presentation</i>	
<i>Identification</i>	6
- General description	7
<i>Name of the parts</i>	
<i>Technical features</i>	8
<i>Materials used</i>	9
<i>Functional check</i>	10
<i>Disinfection</i>	
<i>Assembly</i>	11
- Installation	12
<i>Transport and handling</i>	
<i>Functional check</i>	
<i>Operation and use</i>	13
- Maintenance	14
<i>Periodic verification</i>	
<i>Provision and storage</i>	15
<i>Scrapping</i>	

EC declaration of conformity

Released by:

CALDARA SRL
VIA TRIESTE 31 / B
22036 ERBA, COMO
ITALY
PH. +39 031.640896
info@caldarasrl.it

A - I declare under the sole responsibility of the company that the following products are safe in the conditions of common use in compliance with the instructions and that measures have been taken to ensure the conformity of all the products that have been put on the market with the basic requirements of the directives related to paragraph "B".

Product name: FIXED FLATBED STRETCHER
Code: OW3XL

B - The characteristics of this product are in compliance with the technical parameters related to them and indicated in the DDM 93/42 / CEE which establishes the technical parameters of the health products and the CE labelling requests.

Compliance was assessed with the procedure described in DDM 93/42 / EEC, Annex VII.

NOTE - This CE declaration of conformity also applies to all applicable accessories approved by the manufacturer.

Date and place of release: Erba, 02/01/2020

Claudio Febbi
CEO Caldara s.r.l.

CALDARA s.r.l.

Warranty certificate

This certificate must be kept until the expiry date.

It must be presented every time a technical intervention is necessary, accompanied by the invoice, tax receipt, delivery note or any supporting document showing the name of the retailer and the date of purchase.

The user who is unable to produce these documents will lose all the warranty rights.

The warranty starts from the date of purchase shown on the invoice, receipt or delivery note and it is valid for 24 months for the moving and electric parts, 36 months for the product structure.

The guarantee refers to the replacement or free repair, within the established terms, of the components of the appliance which, at the discretion of the manufacturer, were found to be defective at the origin due to manufacturing defects. This warranty does not cover:

- _ transport faults (dents, scratches and similars);
- _ damage due to falls;
- _ damage caused by carelessness, negligence, inability to use the product, tampering and repairs carried out by unauthorized personnel;
- _ damages due to incorrect installation; if this is carried out by the user or by unauthorized personnel;
- _ damages caused by insufficiency or inadequacy of the electrical system or alterations deriving from environmental, climatic or other conditions, as well as damage caused by phenomena that do not depend on the normal operation of the appliance;
- _ technical interventions concerning the installation of the appliance and the connection to the power supply systems;
- _ home repairs for convenience checks or alleged defects. If requested, the user will have to pay to the person in charge a contribution previously estimated in advance with the intervention;
- _ ordinary maintenance;
- _ whatever may be normal decay for use.

However, product replacement is excluded.

The warranty intervention can be refused when the product has been modified or transformed in any way. The restoration of the appliance will be carried out within the time limits compatible with the organizational requirements, by authorized technicians, upon request by the user to the retailer or directly to the manufacturer.

In the event of home intervention, the user is required to pay the fixed fee for transfer fees.

If the appliance is repaired at the retailer or at the manufacturer, the transport costs and the relative risks will be charged to the user.

Warranty repairs do not result in an extension of the warranty itself.

Parts replaced under warranty remain property of the manufacturer.

No one is authorized to change the terms and conditions of the warranty or to issue other verbal or written ones. The manufacturer declines all responsibility for any damage, of any nature, that may directly or indirectly derive from persons, animals or things resulting from failure to comply with all the instructions contained in this manual concerning, in particular, the installation warnings, use and maintenance of the appliance or in any case improper use.

The manufacturer is also not responsible for any damage caused to people, animals or things due to breakdown or forced suspension of use of the equipment. The Court of Como has jurisdiction for any dispute.

General provisions

Presentation of the manual:

This manual is an integral part of the article.

Carefully read the warnings and instructions contained in this manual as they provide important information regarding SAFETY OF USE AND MAINTENANCE.

The descriptions and illustrations provided in this publication are not binding.

CALDARA S.R.L. reserves the right to make changes that it deems appropriate for the purpose of improvement, without committing to update this documentation.

The illustrations and images contained in this manual are intended as examples only and may differ from practical situations.

The manufacturer assumes no responsibility for direct or indirect damages, including loss of profits, or for any other damage of a commercial nature that may result from the use of the product that does not comply with what is described in this manual.

Customer assistance service:

Customer support and product support are important aspects of our corporate structure.

We are at your complete disposal for further information on the use and maintenance of this product. (info@caldarasrl.it)

Conventions:

The following graphic symbols have been used in this manual:



WARNING! It is placed before certain procedures. Failure to comply may damage the item.



WARNING! It is placed before certain procedures. Failure to comply may damage the operator, the patient or the article.

Safety

General provisions:



WARNING! Improper use and maintenance can cause damage to people and property.



WARNING! NOTICE FOR BLOOD DISEASES: to reduce the risk of exposure during the use of the stretcher, follow the maintenance instructions given in this manual, in addition to the provisions on the safety of personnel prepared by the head of the Emergency Medical Service.

Operators must carefully read this manual, follow the instructions it contains and become familiar with the correct procedures for using and maintaining the product.

Use and maintain the item only as prescribed in this manual and use only spare parts and assistance CALDARA S.R.L.

Keep this manual for consultation and in support of staff training.

Transfer it with the product in case of sale or transfer to new users.

Introduction

Technical presentation:

Fixed top structure with remarkable performance characteristics. The innovative design makes the stretcher absolutely solid and comfortable allowing operators to comfortably perform manoeuvres to the patient. The side rails can be folded down quickly and easily. The upper surface mesh can be removed to ensure better sanitization. The structure is equipped with push handles, 4 bumpers at the corners and a universal cylinder holder. The cushion can be reclined by means of a rack that can be easily operated thanks to the comfortable handle. The wheels are \varnothing 200 two of which with total brake.

The entire structure is painted with grey and white epoxy powders. Thanks to its essential line it is easily washable and easy to sanitise. Very solid product, simple and intuitive assembly.

Reference standards

The article was designed and built by CALDARA S.R.L. in compliance with the safety requisites foreseen by the directive 93/42 / CEE of 14.06.93 (class I) and s.m.i. (Directive 2007/47 / EEC) concerning medical devices.

Intended use

_Type of device: examination bed electrically height adjustable for examinations and therapeutic treatments in ambulatory and hospital environment. INDOOR USE.

_Environmental setting: hospitals and clinics in application environments 2 and 5. The room must be equipped with an electrical system in compliance with the regulations in force.

_ Staff assigned to use the product: specialized operators and doctors.

_ Supervision and responsibility: the bed must be used under the supervision of a doctor.

_Warning: the bed cannot be used in a potentially explosive atmosphere.

_Use limitations: the bed can only be used as described in this manual.

Environmental limits of use

The environmental conditions of use of the chair must follow these indications:

_Temperature: (0 to 50) C °

_Humidity: 10% -90% (not condensed)

Expected life

The bed has been designed to work without danger or risk to things or people, within the limits and conditions defined in this manual for a period of 10 years, after which replacement is recommended.

Correct functioning is guaranteed only by contacting the manufacturer or retailer whenever a fault occurs and in accordance with the instructions contained in this manual.

Manufacturer

The article described in this manual is produced by:

The logo for CALDARA S.R.L. features the word "CALDARA" in a light grey, sans-serif font. A small blue checkmark is positioned below the letter "A".

CALDARA S.R.L. Via Trieste 31/B 22036 Erba (CO) Italy PH +39 031 640896 info@caldarasrl.it
www.caldarasrl.it

Identification:



WARNING! it is forbidden to remove for any reason whatsoever label on the product.

The article can be identified by the label placed on the product where they are the following data are reported:

- _ Name and address of the manufacturer
- _ CE mark
- _ Article Model
- _ Serial number



General description

Component names:

- 1_base
- 2_pedal to lock / unlock wheels
- 3_wheel diam. 200 mm. Anti-trace
- 4_side bumpers
- 5_foot side push handle
- 6_head side push handle
- 7_back section
- 8_foldable side rail
- 9_O₂ cylinder holder



Technical features:

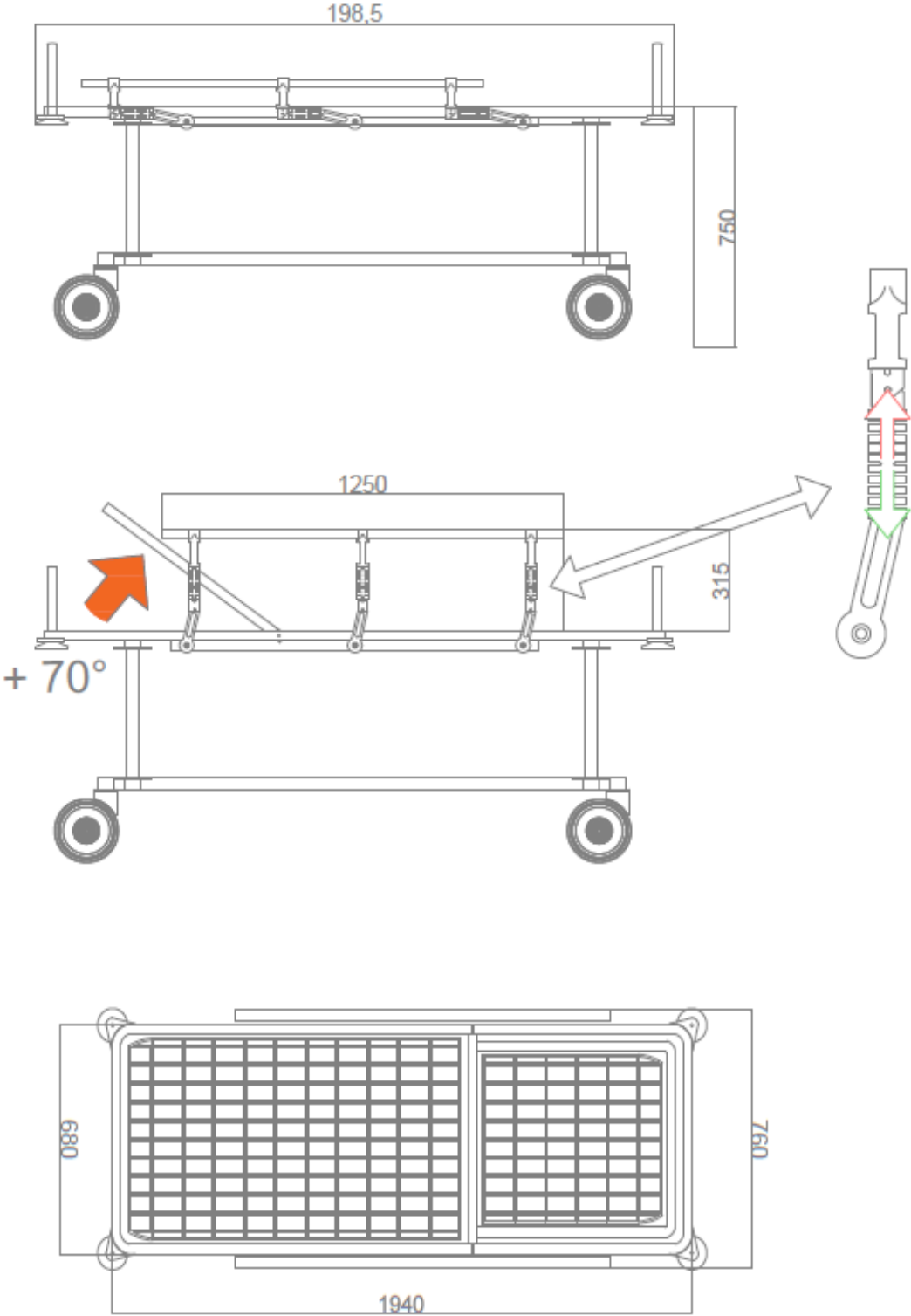

Materials used:

- _ Fe360 steel for the metal structure;
- _ synthetic material, non-marking plastic for the wheels;
- _ plastic material with fiberglass for the side bumper supports;
- _ hydraulic pump for height adjustment of the upper surface;
- _ galvanized metal racks for backrest adjustment;
- _ galvanized steel screws and bolts.

Functional verification:



WARNING! This check must be repeated periodically to verify the efficiency of the product.

Before using the product:
perform the "periodic check" provided in the Maintenance chapter.

Sanitising:



WARNING! Use neutral non-corrosive products available on the market. Sanitising agents can be corrosive.

Carefully read the instructions provided by the manufacturer of the sanitising agent for the specific application.

It is very important to follow the specifications concerning concentration, temperature and reaction times; changing one of these characteristics can cause damage to the product and alter its characteristics. Depending on how the chair is used, the user will establish useful sanitation intervals.

Assembly:

1_ place the push handles as shown in the figure using the two separate ones (A) for the head side and (B) on the foot side. For locking use the handwheels, bumpers and washers in the sequence shown (threaded handwheel, bumpers, washers).

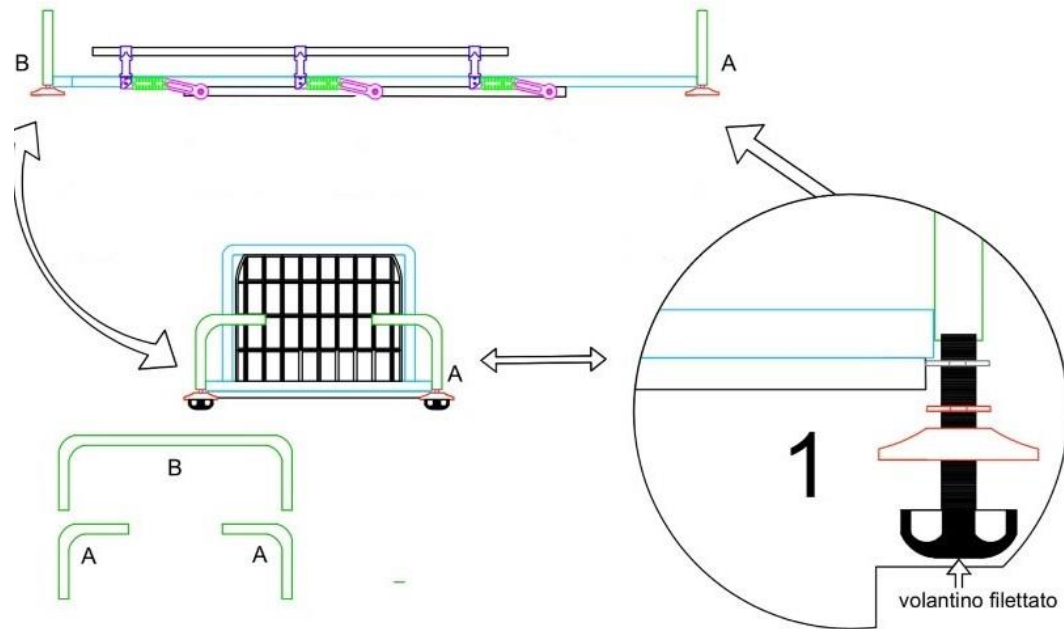

OPT1.OW (IV pole, if included):

1_ mount the stand in a corner of your choice. To mount the IV pole support plate, use the accessories shown above in the following order: threaded handwheel, bumper, washers and IV pole fixing plate. Insert the height-adjustable IV pole.

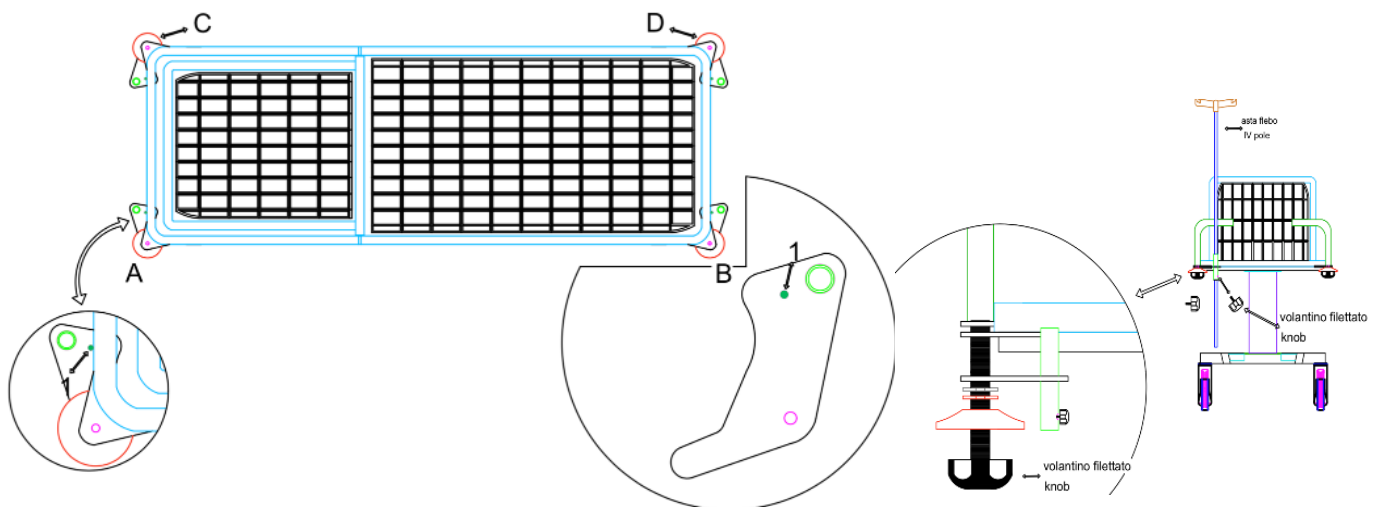

Installation

Transport and handling:



WARNING! The lifting and handling operations must be carried out by specialized personnel trained in this type of operation.

It is necessary to use means suitable for the transport and handling of this product such as manual or self-propelled forklift trucks, taking care to respect the precautions and rules for safety at work.

The product must be installed and used in environments suitable for its use, away from any atmospheric agents capable of compromising its correct use and functioning.

At the time of delivery or collection it is necessary to check that the contents are intact and that the equipment made for its use is also complete; only after carrying out these checks is it possible to eliminate the packaging in disposal and collection places of the recycled material.

If the item is damaged during transport, retain the packaging and contact the carrier within 48 hours of delivery.

Functional verification:



WARNING! This check must be repeated periodically to verify the efficiency of the product.

Before using the product:

perform the "periodic check" provided in the Maintenance chapter.

If the check fails, contact your dealer or CALDARA SRL and take the chair out of service; in case of a positive result, use the product after observing the points described above.

Operation and use:

- 1_ stretcher made for indoor use.
- 2_ use the stretcher on a stable floor.

 **WARNING!** Always, before seating the patient, check that the wheels are locked and adjust the height suitable for your need.

 **WARNING!** Always, before moving the stretcher with the patient, unlock the wheels after making sure that the side rails are raised and locked in order to contain the patient correctly.

- 3_ make the patient sit with the upper surface in a horizontal position and not in the tr / atr position.
- 4_ lock the side rail.

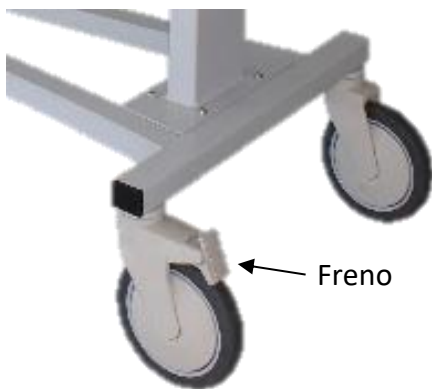
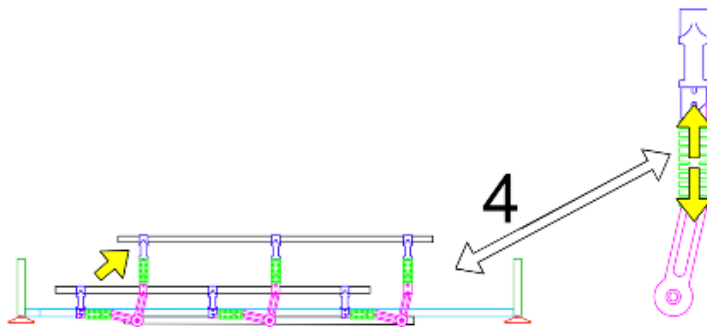

Maintenance

Periodic check:

It is necessary to inspect the product at least once a year.

An inspection means a visual search for any damage that could compromise the integrity and proper functioning of the article. You must check:

- _ integrity of the power cord and plugs;
- _ correct power cable connection;
- _ tightening of screws;
- _ correct functionality;
- _ correct insertion of any accessories.



WARNING! If damage is detected, immediately place the product out of service until it is repaired and put back into service.



WARNING! Any repairs and efficiency improvements are advised to be carried out by specialized technical personnel of the sales or assistance service.

Cleaning:

we recommend an accurate and periodic general cleaning of the product for a longer and better duration.



WARNING! It is recommended NOT to use: thinners, alcohol or petrol, aggressive and abrasive detergents.

Use water and neutral soap, rinse with a damp cloth and dry completely. This is an operation to be performed when necessary or at least every 15 days.

Shelving or storage:

In the event of provision or storage, the following instructions must be followed:

- _pack the product;
- _position it on a flat and safe surface;
- _must be in a dry place and away from the sun;
- _grease the moving parts which could be damaged in case of drying;
- _do not overlap any other item to the one set aside or stored.

Scrapping:

In case you decide not to use this product anymore, you need to:

- _make it inoperative;
- _make any parts that could cause dangers harmless.

In the event that this product is to be scrapped, it is necessary:

- _evaluate the classification of the asset according to the degree of disposal;
- _separate the various components and place them in the appropriate collection centres;
- _if considered special waste, dispose of according to the laws in force.



web link to www.caldarasrl.it

