

INSTRUCTION MANUAL
FOR
Combo Electrotherapy Device
Model: R-C4A

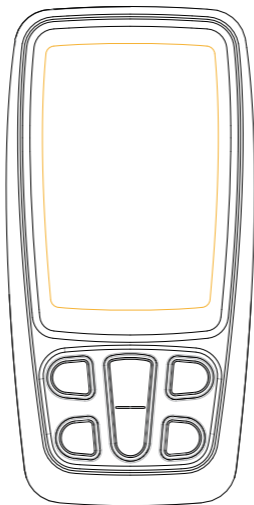

Shenzhen Roundwhale Technology Co., Ltd.
This manual is valid for the R-C4A Stimulator

Be sure to read this instruction manual before operating and
keep it where safe.

This user manual is published by Shenzhen Roundwhale
Technology Co., LTD.

Shenzhen Roundwhale Technology Co., Ltd. does not guarantee its contents and reserves the right to improve and amend it at any time without prior notice. However, Amendments will be published in a new edition of this manual.

All Rights Reserved.

R-C4A Rev.V1.0© 2020, printed in Feb. 24, 2020.

Declaration of conformity:

Shenzhen Roundwhale Technology Co., Ltd. declares that the device complies with following normative documents:

IEC60601-1, IEC60601-1-2, IEC60601-1-11, IEC60601-2-10, IEC62304,

ISO10993-5, ISO10993-10, ISO10993-1, ISO14971

TABLE OF CONTENTS

1. FOREWORD	4
2. SAFETY INFORMATION	6
3. GETTING TO KNOW YOUR DEVICE	11
4. SPECIFICATION	14
5. OPERATING INSTRUCTION	15
6. INSTRUCTIONS FOR USE	21
7. CLEANING AND MAINTENANCE	30
8. TROUBLESHOOTING	32
9. STORAGE	33
10. DISPOSAL	34
11. ELECTROMAGNETIC COMPATIBILITY (EMC) TABLES	34
12. NORMALIZED SYMBOLS	40
13. WARRANTY	41

1. FOREWORD

Introduction

The device R-C4A is a dual channel output TENS, EMS and MASSAGE stimulator. Before using, please read all the instructions in this user manual carefully and keep it safe for future use.

The COMBO stimulator belongs to the group of electrical stimulation systems. It has three basic functions– TENS (Transcutaneous Electrical Nerve Stimulation), EMS (Electronic Muscle Stimulation) and MASSAGE.

Function of the COMBO stimulator: The device has 60 programs (30 TENS programs, 27 EMS programs and 3 MASSAGE programs) and applies electric currents in the low-frequency range for therapy. Each program controls the generated electric impulses, their intensity, frequency and pulse width.

Based on simulating the body's natural pulses, the mechanism of electrical stimulation equipment is to create electric impulses that are transcutaneous transmitted to nerves or muscle fibers through the electrode. The intensity of the dual channel can be adjusted independently and applied individually to one body part. This dual channel device can be used with four pieces of electrodes, which allow you to stimulate one muscle groups simultaneously with a wide selection of standard programs. The electrical pulse is firstly transmitted to the tissue, then it affects the transmission of stimulation in nerves as well as muscle tissues in the body parts.

1.2 Medical background

1.2.1 ABOUT PAIN

Pain is an important signal in the human body warning system. It reminds us that something is wrong, without which, abnormal conditions may go undetected, causing damage or injury to vital parts of our bodies. Even though pain is a necessary warning signal of trauma or malfunction in the body, nature may have gone too far in its design.

Aside from its function in diagnosis, long-lasting persistent pain serves useless purpose.

Pain does not occur until encoded message travels to the brain where it is decoded, analyzed, and reacted to, from the injured area along the small nerves leading to the spinal cord. There the message is transmitted to different nerves that travel up the spinal cord to the brain. Then the pain message is interpreted, referred to and pain is felt.

1.2.2 WHAT IS TENS ?

TENS (Transcutaneous Electrical Nerve Stimulation) is effective in relief of pain. It is daily used and clinically proven by physiotherapists, caregivers and top athletes around the world. High-frequency TENS currents activates the pain-inhibiting mechanisms of the nervous system. Electrical impulses from electrodes, placed on the skin over or near the pain area, stimulate the nerves to block the pain signals to the brain, causing the pain go unperceived. Low-frequency TENS currents facilitate the release of endorphins, the body's natural painkillers.

1.2.3 WHAT IS EMS ?

Electrical Muscle Stimulation is an internationally accepted and proven way of treating muscular injuries. It works by sending electronic pulses to the muscle needing treatment that causes the muscle to exercise passively. It is a product deriving from the square waveform, originally invented by John Faraday in 1831. Through the square wave pattern it

is able to work directly on muscle motor neurons. The EMS System has low frequency and this in conjunction with the square wave pattern allows direct work on muscle groupings.

1.2.4 WHAT IS MASSAGE ?

The massage function is non-medical function. The Massage stimulation program provides relaxing muscle vibration to loosen tight muscles.

2. SAFETY INFORMATION

2.1 Intended use

TENS mode

It is used for temporary relief of pain associated with sore and aching muscles in the neck, shoulder, back, joint, hip, hand, abdomen, foot, upper extremities (arm) and lower extremities (leg) due to strain from exercise or normal household work activities.

It is also intended for symptomatic relief and management of chronic, intractable pain and relief of pain associated with arthritis.

EMS mode

1. Relaxation of muscle spasms
2. Prevention or retardation of disuse atrophy
3. Increasing local blood circulation
4. Muscle re-education
5. Immediate post-surgical stimulation of calf muscles to prevent venous thrombosis
6. Maintaining or increasing range of motion

The device can be used in the home or hospital, using the object (patient) must be 18 years or older of adults.



2.2 Important Safety Precautions and Warnings



It is important that you read all the warnings and precautions included in this manual because they are intended to keep you safe, prevent risk of injury and avoid a situation that could result in damage to the device.

SAFETY SYMBOLS USED IN THIS MANUAL



2.2.1 Contraindication

- 1) Do not use this device if you are using a cardiac pacemaker, implanted defibrillator, or other implanted metallic or electronic devices. Such use could cause electric shock, burns, electrical interference, or death. 
- 2) The device should not be used when cancerous lesions or other lesions are present in the treatment area.
- 3) Stimulation should not be applied over swollen, infected, inflamed areas or skin eruptions (e.g. phlebitis, thrombophlebitis, varicose veins, etc.).
- 4) Electrode placements must be avoided in the carotid sinus area (anterior neck) or transcranially (through the head). 
- 5) This device should not be used in overly enervated areas. 
- 6) Inguinal hernia.
- 7) Do not use on scarred areas following a surgery for at least 10 months after the operation.
- 8) Do not use with serious arterial circulatory problems in the lower limbs.

2.2.2 WARNING

- 1) If you have had medical or physical treatment for your

- pain, consult with your physician before use.
- 2) If your pain is not subdued, which becomes more than mild, or lasts for more than five days, stop using the device and consult with your physician.
 - 3) Do not apply stimulation over your neck because this could cause severe muscle spasms resulting in closure of your airway, difficulty in breathing, or adverse effects on heart rhythm or blood pressure.
 - 4) Do not apply stimulation across your chest because the introduction of electrical current into the chest may cause rhythm disturbances to your heart, which could be lethal.
 - 5) Do not apply stimulation over, or in proximity to, cancerous lesions.
 - 6) Do not apply stimulation in the presence of electronic monitoring equipment (e.g., cardiac monitors, ECG alarms), which may not operate properly when electrical stimulation device is in use.
 - 7) Do not apply stimulation when in bath or shower.
 - 8) Do not apply stimulation while sleeping.
 - 9) Do not apply stimulation while driving, operating machinery, or during any activity when electrical stimulation can put you at risk of injury.
 - 10) Apply stimulation only to normal, intact, clean, healthy skin.
 - 11) The long-term effects of electrical stimulation are unknown. Electrical stimulation device cannot replace drugs.
 - 12) Stimulation should not take place while the user is connected to high-frequency surgical equipment, which may cause burn injuries on the skin under the electrodes, as well as problems with the stimulator.

- 13) Do not use the stimulator in the vicinity of shortwave or microwave therapy equipment, since this may affect the output power of the stimulator.
- 14) Never use it near the cardiac area. Stimulation electrodes should never be placed anywhere on the front of the thorax (marked by ribs and breastbone), but above all not on the two large pectoral muscles. There it can increase the risk of ventricular fibrillation and lead to cardiac arrest. 
- 15) Never use it on the eye, head and face area. 
- 16) Never use it near the genitals.
- 17) Never use it on the areas of the skin which lack normal sensation
- 18) Keep electrodes separate during treatment. It could result in improper stimulation or skin burns if electrodes are in contact with each other.
- 19) Keep the stimulator out of reach of children.
- 20) Consult your doctor if you are in any doubt whatsoever.
- 21) Discontinue it and do not increase the intensity level if you feel discomfort during use.

2.2.3 Precautions

- 1) TENS is not effective for pain of central origin including headache.
- 2) TENS is not a substitute for pain medications and other pain management therapies.
- 3) TENS is a symptomatic treatment and, as such, suppresses the sensation of pain that would otherwise serve as a protective mechanism.
- 4) Effectiveness is highly dependent upon patient selection by a practitioner qualified in the management of

pain patients.

- 5) Since the effects of stimulation of the brain are unknown, stimulation should not be applied across your head, and electrodes should not be placed on opposite sides of your head.
- 6) The safety of electrical stimulation during pregnancy has not been established.
- 7) You may experience skin irritation or hypersensitivity due to the electrical stimulation or electrical conductive medium (silica gel).
- 8) If you have suspected or diagnosed heart disease or epilepsy, you should follow precautions recommended by your physician.
- 9) Caution if you have a tendency to bleed internally, e.g. following an injury of fracture.
- 10) Consult with your physician prior to use the device after a recent surgical procedure, because stimulation may disrupt the healing process.
- 11) Caution if stimulation is intended to be applied over the menstruation or pregnant uterus.
- 12) For single patient use only.
- 13) This stimulator should not be used by patients who is noncompliant and emotionally disturbed including whom with dementia or low IQ.
- 14) The instruction of use is listed and should be obeyed; any improper use may be dangerous.
- 15) Rare cases of skin irritation may occur at the site of the electrode placement following long-term application.
- 16) Do not use this device in the presence of other equipment which sends electrical pulses to your body.
- 17) Do not use sharp objects such as a pencil or ballpoint tip to operate the buttons on the control panel.

- 18) Check the electrode connections before each use.
- 19) Electrical stimulators should be used only with the electrodes recommended for use by the manufacturer.

2.2.4 Adverse Reactions

- 1) Possible skin irritation or electrode burn under the electrodes may occur.
- 2) On very rare occasions, first-time users of EMS report feeling light-headed or faint. We recommend that you use the product while seated until you become accustomed to the sensation.
- 3) If the stimulation makes you uncomfortable, reduce the stimulation intensity to a comfortable level and contact your physician if problems continue.

3. GETTING TO KNOW YOUR DEVICE

3.1 Accessories

No.	Description	QTY
1	The Combo Stimulator	1pc
2	Electrode pad (50mm×50mm)	4pcs
3	Electrode wires	2pcs
4	USB cable	1pc
5	User manual	1pc

3.2 LCD display

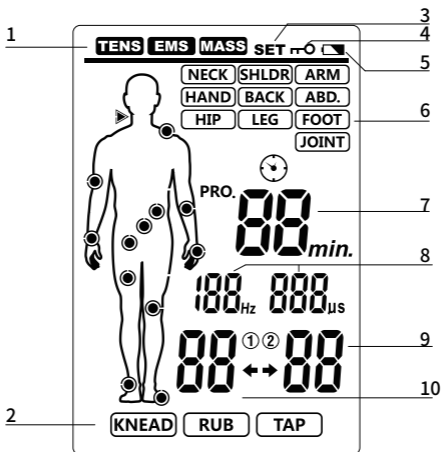

No.	Function description	No.	Function description
1	Treatment mode	6	Treatment body part
2	Massage type	7	Program NO. or Treatment time
3	SET symbol.	8	Pulse rate and width
4	Key locking symbol	9	Intensity for Channel B
5	Low battery symbol	10	Intensity for Channel A

3.3 Device illustration

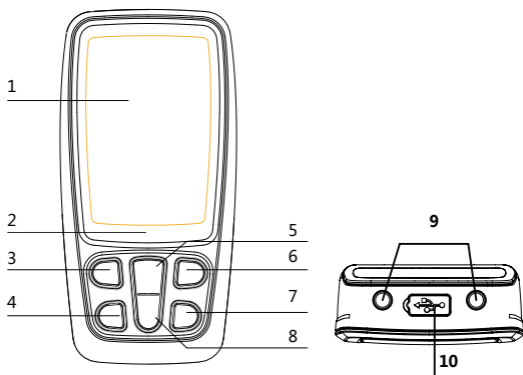

No.	Description
1	LCD display
2	Charger indicator: When the device is charging, the indicator light will be yellow. When charging is completed, the indicator light will be green.
3	[ON/OFF/M] button: At power saving mode, press the [ON/OFF/M] button to turn on the device; At standby mode, press the [ON/OFF/M] button to select the treatment mode; press and hold the [ON/OFF/M] button to turn off the device; At treating mode, press the [ON/OFF/M] button to stop the treatment.
4	[P] button: At standby mode, press the [P] button to select the treatment program. At standby mode, press and hold button to enter the setting treatment time status. At setting mode, press [P] button to select pulse rate, pulse width or treatment time
5	[+] button: At standby or treating mode, press the [+] button to increase the intensity of CH1 and CH2, CH1 or CH2 ; At setting mode, press the [+] button to increase the corresponding data for the pulse rate, pulse width and treatment time.

6	[B] button: At standby mode, press the [B] button to select the treatment body part. At treating mode, press and hold [B] button turn on/off lock function.
7	[CH] button: At standby mode or treating mode, press the [CH] button to select the treatment channel.
8	[-] button: At treating mode, press the [-] button to decrease the intensity of CH1 and CH2 , CH1 or CH2. At setting treatment time status, press the [-] button to decrease the treatment time.
9	Output socket
10	USB socket

4. SPECIFICATION

4.1 Technical information

Device name	Combo Electrotherapy Device
Model/type	R-C4A
Power sources	3.7 V Li-ion battery
Power supply	Input: 100-240V AC, 50/60Hz,0.2A; Output: 5V DC, 300mA
Output channel	Dual channel
Waveform	Bi-phase square-wave pulse
Output current	Max. 120mA (at 500ohm load)
Output intensity	0 to 40 levels, adjustable
Treatment mode:	TENS, EMS and MASSAGE mode
Operating condition	5° C to 40° C with a relative humidity of 15%-93%, atmospheric pressure from 700 hPa to 1060 hPa
Storage condition	-10° C to 55° C with a relative humidity of 10%-95%, atmospheric pressure from 700 hPa to 1060 hPa
Dimension	109*54.5*23mm (L x W x T)
Weight	About 82g
Automatic shutoff	1 minute
Classification	BF type applied part, internal power equipment, IP22

Electrode detection function	The electric current level will be reset to 0 mA, when the amplitude level is 1 or greater and an open circuit at either channel is detected.
Size of electrodes pad	50x50mm, square
Output precision	±20% error is allowed for all the output parameters

TENS mode

Number of programs	30 programs(10 treatment body parts)
P.W. (pulse width)	55-300 μ s
P.R. (Frequency)	2-120Hz (Hz=vibration per second)
Treatment time	5-90 minutes (adjustable)

EMS mode

Number of programs	27 programs (9 treatment body parts)
P.W. (pulse width)	100-300 μ s
P.R. (Frequency)	4-100Hz (Hz=vibration per second)
Treatment time	5-90 minutes (adjustable)

MASSAGE mode

Number of programs	3 programs
P.W. (Pulse width)	100-250 μ s
P.R. (Pulse Rate)	25-100Hz (Hz=vibration per second)
Treatment time	30 minutes

5. OPERATING INSTRUCTION

5.1 Connect electrode pads to electrode wires

Insert the electrode wires connector into electrode connector. Make sure they are properly connected to ensure the good performance. Please refer to the picture.

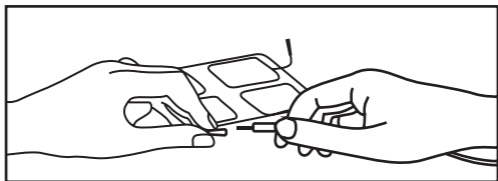

⚠ Caution

Always use the electrode pads which comply with the requirements of the IEC/EN60601-1, ISO10993-1/-5/-10 and IEC/ EN60601-1-2, as well as CE and FDA 510(K) regulation.

5.2 Connect electrode pads to electrode wires

Before proceeding to this step, ensure that the device is completely switched OFF. Hold the insulated portion of the electrode wire connector, and insert the plug into the receptacle on the top of the main device.

Ensure the electrode wires are inserted correctly. The device has two output receptacles controlled by Channel A and Channel B at the top of the unit. You may choose to use one channel with one pair of electrode wires or both channels with two pairs of electrode wires.

Using both channels gives the user the advantage of stimulating two different areas at the same time.

⚠ Caution

Do not insert the plug of the electrode wires into any AC power supply socket.

5.3 Electrode

5.3.1 Electrode options

The electrodes should be routinely replaced when they start to lose their adhesiveness. If you are unsure of your electrode adhesive properties, please order new replacement electrodes. Replacing electrodes should be re-ordered under the advice of your physician or the device manufacturer to ensure proper quality. Follow application procedures outlined on electrode packing when using the new replacement electrodes to maintain optimal stimulation and to prevent skin irritation.

5.3.2 Place electrodes on skin

Place the electrode on the body part in need of treatment, according to the instruction of this user manual. Please make the skin clean before use and ensure the skin and electrode connect well.

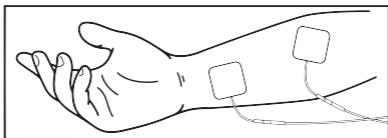

Caution







1. Always remove the electrodes from the skin with a moderate pull in order to avoid injury in the event of highly sensitive skin.
2. Before applying the self-adhesive electrodes, it is recommended to wash and degrease the skin, and then dry it.
3. Do not turn on the device when the self-adhesive electrodes are not positioned on the body.
4. To remove or move the electrodes, switch off the device or the appropriate channel first in order to avoid unwanted irritation.
5. It is recommended that, at minimum, 1.97" x 1.97" self-ad-

- hesive square electrodes are used at the treatment area.
6. Never remove the self-adhesive electrodes from the skin while the device is still on.

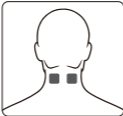
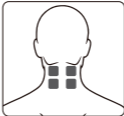
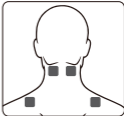
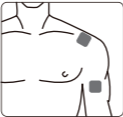
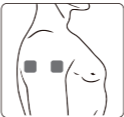
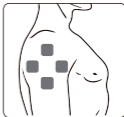
5.3.3 Electrode placement

R-C4A is a kind of OTC stimulator, suitable for home use. You only have to use according to the user manual, place the electrode on the position where you feel pain. Conduct exercise, treatment and adjustment based on your own feeling.

Position of electrode placement under TENS programs



Neck				
Shoulder				
Arm				
Hand				

Back				
Abdomen				
Hip				
Leg				
Foot				
Joint (knee)				
Joint (elbow)				

Joint (ankle)			
Joint (wrist)			

Position of electrode placement under EMS programs

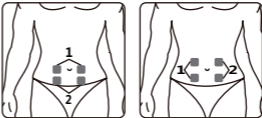
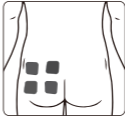
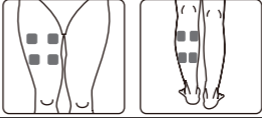
Neck				
Shoulder				
Arm				
Hand				
Back				

Abdomen	
Hip	
Leg	
Foot	

6. INSTRUCTIONS FOR USE

6.1 Turn on

Press the [ON/OFF/M] button to turn on the device, the LCD will be lit. And then it goes into the standby mode as the picture shown below.

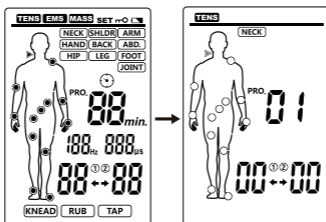

6.2 Select treatment mode

Press the [ON/OFF/M] button to select which treatment mode (TENS – MASS - EMS) you will use. The LCD displays as follows:

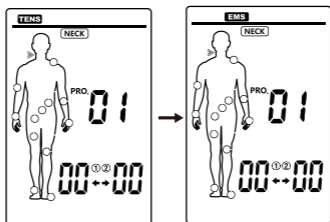

6.3 Select treatment body part

Based on your need, Press the [B] button to select the current treatment body part. The LCD displays as follows:

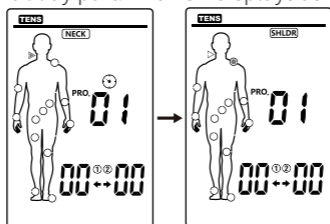

6.4 Select treatment program

Based on your need, press [P] button to select the treatment program. The LCD displays as follows:

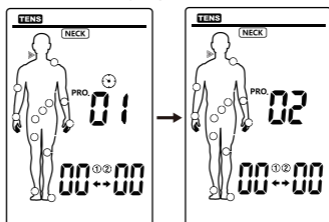

6.5 Select treatment channel

Press the [CH] button to select the treatment channel. The LCD displays as follows:

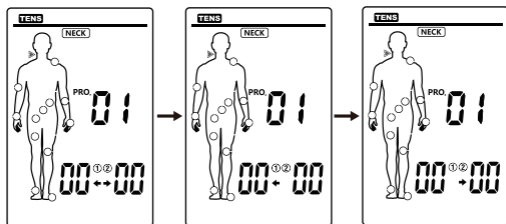

6.6 Set program parameter

Press and hold [P] button to enter the setting mode.

1) In the program p1 and p2, Press [+] / [-] button to adjust treatment time.

The LCD displays as follows:

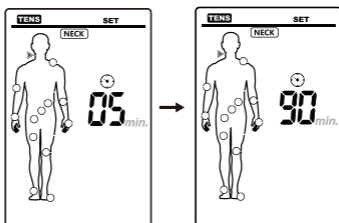

2) In the program u1, press [P] button to adjust pulse rate -> pulse width -> treatment time by setting the parameter. Press [+] / [-] button to adjust corresponding data.

The LCD displays as follows:

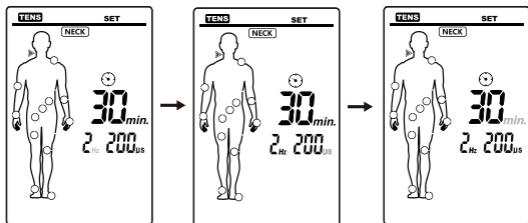

3). Press [ON/OFF/M] button to return to the standby mode.

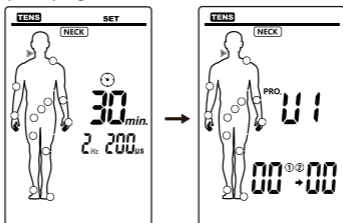

6.7 Start treatment

Press the [+] button to increase the intensity of the selected treatment channel. The LCD displays as follows:

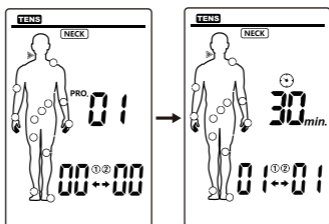

6.8 Adjust the output intensity

Press the [+] button to increase output intensity. It will be

increased to a higher level after each press. The device has totally 40 levels of output intensity. Please adjust the intensity to the condition that you feel comfortable. The level of output intensity will be shown on the LCD:

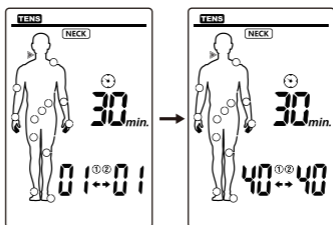

At treating status, press and hold [B] button to turn on lock function. The indicator '⌘O' will display on the LCD. This is a safety feature to prevent accidental changes to your settings and to prevent accidentally increasing the output intensity level. Press and hold [B] button to unlock.

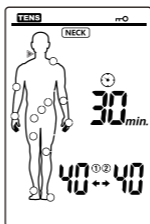

If you feel it too strong, you can press [-] button to decrease the intensity to a lower level each time. When the output intensity of both channels decrease to zero, the stimulator will return to the standby mode. The LCD displays as follows:

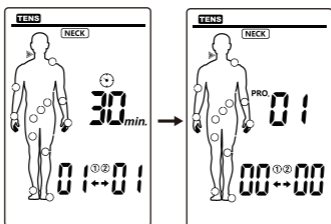

Caution:

If you feel or become uncomfortable, reduce the stimulation intensity to a more comfortable level and consult with your medical practitioner if problems insist.

6.9 Stop the treatment and turn off the device

Press the [ON/OFF/M] button to stop treatment during the treating mode. Press the [ON/OFF/M] button again to turn off the stimulator, and the LCD will be blank.

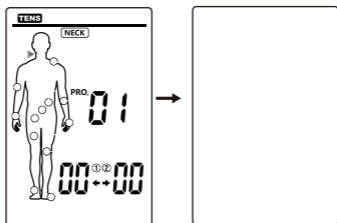

6.10 Load detection

It will automatically detect the load if the intensity is above level 5. If it hasn't detected the load or the electrode contacts the skin not well enough, the intensity will automatically return to level 0 and the symbol '①' or '②' twinkles. And the stimulator returns to the standby mode.

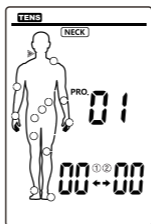

6.11 Low battery detection

When the battery is low, the  icon will twinkle to indicate it, stop the device and charge the battery.

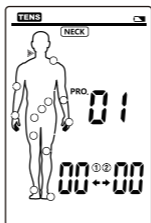

Charging the Battery:

Proceed as follows to recharge the battery:

- This device cannot be used while charging.
- Make sure that the device is no longer connected to the patient (the output cables and electrodes must be disconnected).
- Connect the USB cable to the charging port on the device.
- Connect the USB cable to the charger.
- When the device is charging, the indicator light will be yellow.
- It could take up to 2 hours to reach a full charge.

- When charging is completed, the indicator light will be green.

The life of a rechargeable battery depends on the number of recharging/run-down cycles it undergoes and how these cycles are performed.

The following suggestions will help prolong the life of the battery:

- Whenever the device is not used frequently, charge the battery once a month.
- For longer battery life, discharge the battery as much as possible.

6.12 Usage of electrode pads

1. The electrode may only be connected with the COMBO stimulator. Make sure that the device is turned off when attaching or removing the electrode pads.
2. If you want to reposition the electrode during the application, turn the device off first.
3. The usage of electrode may lead to skin irritations. If you experience such skin irritations, e.g. redness, blistering or itching, discontinue using them. Do not use the COMBO stimulator permanently on the same body part, as this may also lead to skin irritations.
4. Electrode pads are private and intended for single person use. Please avoid using them by different persons.
5. The electrode must connect entirely to the skin surface to prevent hot spots, which may lead to skin burns.
6. Do not use the electrode pads for more than approx. 10 times, as connection between the electrodes and the skin deteriorates over time.
7. The adhesive force of the electrodes depends on the skin properties, storage condition, and the number of

applications. If your electrode pads no longer fully stick to the skin's surface, replace them with new ones. Stick the electrode pads back onto the protective foil after use and store them in the storage bag to prevent them from drying out. This retains the adhesive force for a longer period.

Caution:

- 1) Before applying the electrode, it is recommended for users to wash and degrease the skin, and then dry it.
- 2) Never remove the electrode from the skin while the device is still on.
- 3) Only use the electrode pads provided by the manufacturer. Usage of other companies' products could result in injuries to the user.

6.13 Where do I attach electrode pads?

1. Each person reacts differently to electric nerve stimulation. Therefore, the placement of the electrodes may deviate from the standard. If application is not successful, contact your physician to find out which placement techniques are best for you.
2. Do not use any adhesive electrodes with a size smaller than those the original manufacturer attached. Otherwise the current density may be too high and cause injuries.
3. The size of the adhesive pads may not be changed, e.g. by clipping off parts of them.
4. Make sure that the region radiating the pain is enclosed by the electrodes. In case of painful muscle groups, attach the electrodes in such a way that the affected muscles are also enclosed by the electrodes.

Usage advice for TENS:

- 1) If you feel the output intensity too strong, you can press [-] button to decrease it;
- 2) If you don't feel any discomfort during the treatment, we advise you to use the device until the session ends. Normally, the pain relief occurs after 5~10 mins treatment;
- 3) Normally, we advise 1~2 treatments per day and one week as a period of treatment;
- 4) After a period of treatment, if the pain relief is not achieved or the pain gets even worse, please consult your doctor.

Usage advice for EMS:

- 1) Place the electrodes on the body part you want to treat referring to the picture on Section 5.3.3;
- 2) 1~2 treatment per day, about one week as a period of treatment;
- 3) We advise you to use the device for one session per time. If you feel discomfort during treatment, you can either pause the session or decrease the intensity of the output.

7. CLEANING AND MAINTENANCE

Fully comply with the following necessary daily maintenance requirements to make sure the device is intact and guarantee its long-term performance and safety.

7.1 Cleaning and care for the device

- 7.1.1 Pull the electrodes out of the stimulator, clean the device with a soft, slightly damp cloth. In case of heavier dirt build-up, you may also apply a mild detergent.

- 7.1.2 Do not expose the COMBO stimulator to moisture or dampness. And do not hold the COMBO stimulator under running water, nor submerge it in water or other liquids.
- 7.1.3 The COMBO stimulator is sensitive to heat and may not be exposed to direct sunlight. And do not place it on hot surfaces.
- 7.1.4 Clean the surface of the electrode pads carefully with a damp cloth. Make sure the device is turn off!
- 7.1.5 For reasons of hygiene, each user should use his/her own set of electrodes.
- 7.1.6 Do not use any chemical cleaners or abrasive agents for cleaning.
- 7.1.7 Ensure that no water penetrates into the machine. Should this happen, use the device again only when it is completely dry.
- 7.1.8 Do not clean the device during treatment. Be sure that the device is turned off and the battery is unloaded before cleaning.

7.2 Maintenance

- 7.2.1 The manufacturer didn't authorize any maintenance agencies abroad. If your device has any problems, please contact the distributor. The manufacturer will not be responsible for the results of maintenance or repairs by unauthorized persons.
- 7.3.2 The user must not attempt any repairs to the device or any of its accessories. Please contact the retailer for repair.
- 7.3.3 Opening of the equipment by unauthorized agencies is not allowed and will terminate any claim to warranty.

Each product in manufacturing has been inspected through

systematic validation. The performance is stable and does not need to undertake calibration and validation.

If your product can't reach the expected performance and the basic function has changed in normal use, please contact the retailer.

8. TROUBLESHOOTING

Should any malfunction occur while using the device, check whether the parameters are set appropriately for therapy, and adjust the control correctly. Please see the following table:

Malfunction	Common reasons	Countermeasure
No display	The battery is exhausted	Charge in time
No sensation of stimulation or weak stimulation	<ol style="list-style-type: none">1. The electrode does not connect well to the skin.2. If the connection between electrode connects well to the stimulator.3. The battery is used up.4. The skin is too dry.	<ol style="list-style-type: none">1. Check and re-paste it on skin.2. Check the connection.3. Charge.4. Wipe the electrode and the skin with a wet cotton cloth.
Automatic halt in the treatment	<ol style="list-style-type: none">1. The electrode loses connection with the skin.2. If the battery is used up.	<ol style="list-style-type: none">1. Check and place the electrode properly on the skin.2. Charge

<p>Rash or tickle on the skin occurs in the treatment</p>	<ol style="list-style-type: none"> 1. The treatment time lasts too long. 2. The electrode does not stick well to the skin. 3. The interface of the electrodes is dirty or dry. 4. The skin is sensitive to the electrode. 	<ol style="list-style-type: none"> 1. Do the treatment once a day and shorten the treatment time. 2. Check and stick the electrode well. 3. Wipe the electrode with a wet cotton cloth before use. 4. Check your allergic history. Please change the sticking place or shorten the treatment time. If your skin is over-sensitive, you should stop the treatment or go to see a doctor.
-----------------------------------------------------------	---------------------------------------------------------------------------------------------------------------------------------------------------------------------------------------------------------------------------------------------------------------------	-----------------------------------------------------------------------------------------------------------------------------------------------------------------------------------------------------------------------------------------------------------------------------------------------------------------------------------------------------------------------------------------------------------------------------------

9. STORAGE

9.1 Storing the Electrode Pads and Lead Wires

1. Turn the device off and remove the lead wires from the unit.
2. Remove the electrodes from your body and disconnect the lead wires from the electrodes.
3. Place the electrodes onto the plastic film and then store into the sealed package.
4. Wrap the lead wires and store into the sealed package.

9.2 Storing the Unit

1. Place the unit, electrodes, lead wires and manual back

into the gift box. Store the box in a cool, dry place, -10°C ~ 55°C ; 10% ~ 90% relative humidity.

2. Do not keep in places that can be easily reached by children

10. DISPOSAL



Spent batteries do not belong to the household wastes. Disposal of the battery according to the current regulations. As a consumer, you have the obligation to dispose of batteries correctly.

Consult your municipal authority or your dealer for information about disposal.

At the end of the product lifecycle, do not throw this product into the normal household garbage, but bring it to a collection point for the recycling of electronic equipment.

Obsolete electrical and electronic equipment may have potentially harmful effects on the environment. Incorrect disposal can cause toxins to build up in the air, water and soil and jeopardize human health.

11. ELECTROMAGNETIC COMPATIBILITY (EMC) TABLES

Guidance and manufacture's declaration - electromagnetic emissions

The device is intended for use in the electromagnetic environment specified below. The customer or the user has to assure that it is used in such environment.

Emissions test	Compliance	Electromagnetic environment - guidance
----------------	------------	----------------------------------------

RF emissions CISPR11	Group 1	The device uses RF energy only for its internal function. Therefore, its RF emissions are very low and are not likely to cause any interference in nearby electronic equipment.
RF emissions CISPR11	Class B	The device is suitable for use in all establishments including those directly connected to the public low-voltage power supply network that supplies to buildings power used for domestic purposes
Harmonic emissions IEC 61000-3-2	Not applicable	
Voltage fluctuations/ Flicker emissions IEC 61000-3-3	Not applicable	

Guidance and manufacturer's declaration – electromagnetic immunity

The device is intended for use in the electromagnetic environment specified below. The customer or the user of the device should assure that it is used in such environment.

Immunity test	IEC 60601 Test level	Compliance level	Electromagnetic environment-guidance
Electrostatic discharge (ESD) IEC 61000-4-2	± 8 kV direct & indirect contact; ± 15 kV air discharge	± 8 kV direct & indirect contact; ± 15 kV air discharge	Floors should be wood, concrete or ceramic tile. If floors are covered with synthetic material, the relative humidity should be at least 30%
Electrical fast transient/burst IEC 61000-4-4	± 2 kV for power supply lines	not applica- ble	not applicable (for INTERNALLY POWERED ME EQUIPMENT)
Surge IEC 61000-4-5	± 1 kV line(s) to line(s)	not applica- ble	not applicable (for INTERNALLY POWERED ME EQUIPMENT)

<p>Voltage dips, short interruptions and voltage variations on power supply input lines IEC 61000-4-11</p>	<p><5% U_T (>95% dip in U_T) for 0.5 cycle</p> <p>40% U_T (60% dip in U_T) for 5 cycles</p> <p>70% U_T (30% dip in U_T) for 25 cycles</p> <p><5% U_T (>95% dip in U_T) for 5 sec</p>	<p>not applicable</p>	<p>not applicable (For INTERNALLY POWERED ME EQUIPMENT</p>
<p>Power frequency (50Hz/60Hz) magnetic field IEC 61000-4-8</p>	<p>10V/m</p>	<p>10V/m</p>	<p>Power frequency magnetic fields should be at levels characteristic of a typical location in typical commercial or hospital environment.</p>

NOTE U_T is the a.c. mains voltage prior to application of the test level.

Guidance and manufacture's declaration – electromagnetic immunity

The device is intended for use in the electromagnetic environment specified below. The customer or the user of device should assure that it is used in such environment.

<p>Immunity test</p>	<p>IEC 60601 test level</p>	<p>Compliance level</p>	<p>Electromagnetic environment - guidance</p>
----------------------	-----------------------------	-------------------------	-----------------------------------------------

Radiated RF IEC 61000-4-3	10V/m & table 9	10V/m & table 9	<p>Portable and mobile RF communications equipment should be used not closer to any part of the device, including cables, than the recommended separation distance calculated from the equation applicable to the frequency of the transmitter.</p> <p>Recommended separation distance</p> <p>$d = 1.167\sqrt{P}$ 80 MHz to 800 MHz</p> <p>$d = 2.333\sqrt{P}$ 800 MHz to 2.5 GHz</p> <p>Where P is the maximum output power rating of the transmitter in watts (W) according to the transmitter manufacturer and d is the recommended separation distance in metres (m).</p> <p>Field strengths from fixed RF transmitters, as determined by an electromagnetic site survey,^a should be less than the compliance level in each frequency range.^b</p> <p>Interference may occur in the vicinity of equipment marked with the following symbol: </p>
NOTE 1	At 80 MHz and 800 MHz, the higher frequency range applies.		
NOTE 2	These guidelines may not apply in all situations. Electromagnetic propagation is affected by absorption and reflection from structures, objects and people.		

- a Field strengths from fixed transmitters, such as base stations for radio (cellular/cordless) telephones and land mobile radios, amateur radio, AM and FM radio broadcast and TV broadcast cannot be predicted theoretically with accuracy. To assess the electromagnetic environment due to fixed RF transmitters, an electromagnetic site survey should be considered. If the measured field strength in the location in which the device is used exceeds the applicable RF compliance level above, the device should be observed to verify normal operation. If abnormal performance is observed, additional measures may be necessary, such as reorienting or relocating the device.
- b Over the frequency range 150 kHz to 80 MHz, field strengths should be less than $[V_i]$ V/m.

Test specifications for ENCLOSURE PORT IMMUNITY to RF wireless communications equipment (Table 9)









Test frequency (MHz)	Band ^{a)} (MHz)	Service ^{a)}	Modulation ^{b)}	Maximum power (W)	Distance (m)	Immunity Test Level (V/m)
385	380-390	TETRA 400	Pulse modulation ^{b)} 18Hz	1.8	0.3	27
450	430-470	GMRS 460, FRS 460	FM ^{c)} ± 5 kHz deviation 1kHz sine	2	0.3	28
710	704-787	LTE Band 13, 17	Pulse modulation ^{b)} 217Hz	0.2	0.3	9
745						
780						
810	800-960	GSM800/900, TETRA 800, iDEN 820, CDMA 850, LTE Band 5	Pulse modulation ^{b)} 18Hz	2	0.3	28
870						
930						

1720	1700-1990	GSM1800; CDMA 1900; GSM 1900; DECT; LTE Band 1,3, 4,25; UMTS	Pulse modu- lation ^{b)} 217Hz	2	0.3	28
1845						
1970						
2450	2400-2570	Bluetooth, WLAN, 802.11 b/g/ n, RFID 2450, LTE Band 7	Pulse modu- lation ^{b)} 217Hz	2	0.3	28
5240	5100-5800	WLAN 802.11 a/n	Pulse modu- lation ^{b)} 217Hz	0.2	0.3	9
5500						
5785						

NOTE If it is necessary to achieve the IMMUNITY TEST LEVEL, the distance between the transmitting antenna and the ME EQUIPMENT or ME SYSTEM may be reduced to 1 m. The 1 m test distance is permitted by IEC 61000-4-3.

- a) For some services, only the uplink frequencies are included.
- b) The carrier shall be modulated using a 50 % duty cycle square wave signal.
- c) As an alternative to FM modulation, 50 % pulse modulation at 18 Hz may be used because it does not represent actual modulation. It would be worst case.

13. Normalized symbols

	WEEE disposal
	Type BF applied part
	Follow instructions for use
IP22	Covering Protection rate
	Lot number
	Manufacturer
	Date of manufacture
	Authorized representative in the European community
	Serial number
	Medical Device complies with Directive 93/42/EEC

13. WARRANTY

Please contact your dealer or the device center in case of a claim under the warranty. If you have to return the unit, enclosing a copy of your receipt with clear statement of defect description.

The warranty terms are as below:

1. The warranty period for this device is 1 year from date of purchase. In case of a warranty claim, the date of purchase has to be proven by means of the sales receipt or invoice.
2. Repairs under warranty should be in the warranty period either for the device or for the replacement parts.
3. The following cases are excluded under the warranty
 - All damages that arise due to improper operation, e.g. nonobservance of the user instruction.
 - All damages due to repairs or tampering by the customer or unauthorized third parties.
 - Damage which has arisen during transport from the manufacturer to the consumer or the service centre.
 - Accessories which are subject to normal wear and tear.
 - Device damages due to privately disassembling devices.
4. Liability for direct or indirect consequential losses caused by the unit is excluded even if the damage to the unit is accepted as a warranty claim

REF R-C4A (**GIMA 28405**)

CE 2460



Shenzhen Roundwhale Technology Co., Ltd.
202, 2/F, Building 27, Dafa Industrial Park, Longxi Community,
Longgang Street, Longgang District, Shenzhen, China.
MADE IN CHINA

EC **REP**

Shanghai International Holding Corp. GmbH (Europe)
Eiffestrasse 80, 20537 Hamburg, Germany



Imported by: Gima S.p.A.

Via Marconi, 1 - 20060 Gessate (MI) Italy
gima@gimaitaly.com - export@gimaitaly.com
www.gimaitaly.com

