

Operative manual for diagnosis lamp SOLESUD



Via Marconi, 1 – 20060 GESSATE (MI) ITALIA

Tel. +39 02 953854209 Fax +39 02 95381167

<http://www.gimaitaly.com> e-mail: gima@gimaitaly.com

Introduction

	Pag.
1. General information	2
1.1 Qualification of operators.	3
1.2 Packaging, Transport, Storage, and Characteristic of the installation site	3
1.3 Graphic symbols used on the Product and packaging	3
1.4 CE declaration of Conformity of the Manufacturer.	4
1.5 Warranty Certificate.	5
2. Product Installation	6
2.1 Installation mobile version	6
2.2 Installation wall version (S/12MED fixing)	6
2.3 Installation wall version (rail bar fixing)	6
2.4 Installation table version (S11 fixing)	6
2.5 First starting.	6
2.6 Installation verification and Product testing operations before use	6
3. Importance of personal safety	7
3.1 Intended use.	7
3.2 Environmental conditions.	7
3.3 Other secondary conditions (secondary effects)	7
4. Description of the operations	7
5. Cleaning and disinfection	7
5.1 Cleaning the Product.	7
5.2 Disinfecting	8
6. Adjustments	8
6.1 Yearly inspections by the operator	8
6.2 Repairs	8
6.3 Adjustments	8
6.4 Troubleshooting.	8
6.5 Bulb substitution	8
6.6 Routine maintenance	9
7. Technical data	9
8. Electrical diagram	10
9. EMC declaration	11

Introduction

Dear user You are kindly invited to read this manual carefully before proceeding to use the Product in order to safeguard yourself and other people from any injuries.

This appliance is a Class 1 medical device pursuant to European Directives on medical devices (MDD) 93/42/EEC, Annex IX, and 2007/47/EC.

The manufacturer declares that this product is in compliance with Annex I (essential requirements of Directive 93/42/EEC and certifies such conformity by affixing the CE mark.

This operator's manual refers to the product **SOLESUD**.

The customer service is at your disposal in case of Product details, information concerning its use, identification of spare parts being required and for any other queries you might have concerning the appliance, for ordering spares and for matters relating to assistance and warranty.

GIMA TECHNICAL ASSISTANCE OFFICE FOR CLIENTS

Via Marconi, 1 – 20060 GESSATE (MI) ITALY

Tel. +39 02 953854209 Fax +39 02 95381167

<http://www.gimaitaly.com> e-mail: gima@gimaitaly.com

The contents of this Manual may be amended by GIMA, without prior notice or any further obligations, in order to make changes and improvements. The reproduction, including partial, or translation of any part of this manual is forbidden without the written permission of GIMA.

GIMA reserves the right to change, cancel or otherwise amend the data contained in this document at any time and for any reason without prior notice inasmuch as GIMA is constantly seeking new solutions which lead to product evolution. GIMA therefore reserves the right to make changes to the supplied Product in terms of shape, fittings, technology and performances.

With regard to translations into languages other than Italian, reference shall always be made to the Italian edition of this operator's manual.



1. General information

The ME (Medical-Electrical) EQUIPMENT to which this manual refers is a LAMP for diagnosis or observation. For easier description such ME EQUIPMENT will be indicated in this manual with the name of "Product".

This manual is an integral part of the Product as required by European directive 93/42/EEC and 2007/47/EC. Always keep this installation manual close to the Product.

The Product is not suitable for use in explosion-risk areas

- The Product is not suitable for use in the presence of inflammable mixtures of anaesthetics with air, oxygen or NO₂ (laughing gas)

GIMA disclaims all liability for any injuries to persons or damage to things caused by the installation, maintenance or use of the Product by unqualified operators. By qualified operator is meant whosoever has attended a course relating to the installation, maintenance and use of the product organised by GIMA or, alternatively, whosoever has carefully read this installation manual.

The only party responsible for Product installation is the buyer's customer itself; no cost or responsibility relating to installation and/or commissioning of the Product shall therefore be traced back and/or in any case attributed to GIMA.

The masonry works involving the preparation of the ceiling or wall, for Products to be installed on the ceiling or wall respectively, and the electric works for preparing the power supply system for the Product shall be of a sturdy and safe nature and completed in a workmanlike manner by suitably trained personnel.

By way of example only, without limitation, the following professional figures are deemed adequately trained:

⇒ Building Engineer, Draughtsman, Building firm duly registered in the professional Register (for masonry works)

⇒ Electro-technician qualified to exercise the profession of electrician (for the electrical works)

The Product is a ME EQUIPMENT and consequently falls within the field of application of the EN:62353 standard.

Consequently, any operation performed on the Product must be carried out in compliance with the EN:62353 standard, where applicable.

1.1 Qualification of operators

This paragraph describes the requirements and qualifications which the operators involved in the various stages of Product life and use must possess.

Installation	Qualified Installer and/or Technician
Use	Professional medical personnel
Routine maintenance (about every year)	Qualified technician in possession of professional technical requirements
Special maintenance (in case of necessity)	Qualified technician in possession of professional technical requirements
Assistance	GIMA or authorized dealer
Cleaning	Properly trained medical and paramedical personnel
Demolition	In compliance with the national directives applicable to waste disposal.

1.2 Packaging, transport, Storage and characteristic of the installation site

Boxes containing the whole structure, with installation manual and user manual.

Transport is carried out by any road haulage contractor as long as they respect the following characteristics:

Temperature (°C): -15 / +60; Humidity: 10 / 75 %; Atmospheric pressure (h/Pa): 500 / 1060.

The devices packaged must be stored (warehoused) in a dry place and at the following temperature:











Temperature (°C): +10 / +40; Humidity: 10 / 75 %; Atmospheric pressure (h/Pa): 500 / 1060.

The site appointed for the installation of the equipment must have the following characteristics:

Temperature (°C): +10 / +40; Humidity: 30 / 75 %; Atmospheric pressure (h/Pa): 700 / 1060.

1.3 Graphic symbols used on the Product and packaging

Description symbols present on labels, on product, and manual:

	Graphic symbol proving the CE marking of the product		RECYCLING! Product must be recycled separately
	Symbol indicating the manufacture date (month and year)		B-Type device. Indicates the level of protection against direct and indirect contact
	Consult accompanying document		Attention
	Address of the Manufacturer		Maximum number of packages stackable
	Maximum number of packages stackable		Breakable package

1.4 **CE** Declaration of Conformity of the Manufacturer

The company:

RIMSA P. LONGONI S.r.l. Via Monterosa, 18/20/22 - 20831 SEREGNO (MB) - ITALY

Declares under its own responsibility that the Product (Medical lighting device for surgical and diagnosis use):

SOLESUD
APPLICARE ETICHETTA

made by RIMSA P.LONGONI S.r.l., complies with Annex VII of Directive 93/42/EEC dated 14/05/1993, and subsequent amendments (including Directive 2007/47/EC dated 05/09/2007) and the following standards:

- IEC 60601-1 (Part 1: General requirements for basic safety and essential performance)
- IEC 60601-2-41 (Part 2: Particular requirements for basic safety and essential performance of surgical luminaires and luminaires for diagnosis)
- IEC 60601-1-2 (Part 1: General requirements for basic safety and essential performance – Collateral standard: Electromagnetic compatibility – Requirements and tests)

Classification with reference to article 9 and Annex IX of Directives 93/42/EEC and 2007/47/EC

DURATION: Short term (Par.1 “Definitions”, art.1, sub-section 1.1, annex IX)
DESCRIPTION: Non-invasive medical device (Par.1 “Definitions”, art.1, sub-section 1.2, annex IX)
Active medical device (Par.1 “Definitions”, art.1, sub-section 1.4, annex IX)
CLASS: I (Par.3 “Classification”, art.1, sub-section 1.1 Rule 1, annex IX)

- Reference to technical file Code RIM-FT010.
- The conformity assessment is developed with reference to article 11 of Directive 93/42/EEC and 2007/47/EC.
- The RIMSA Quality System complies with UNI EN ISO 9001 and UNI CEI EN ISO 13485 standards and is certified by CSQ (CSQ certificate no. 9120.RMS1 and 9124.RMS2).
- The Medical Device to illuminate the body of the patient locally is supplied in **NOT STERILIZED** form.

Name: Paolo Longoni
Position: Managing Director



RIMSA P. LONGONI S.r.l.

1.5 Warranty Certificate

1. The appliance is covered by an 18-month warranty, including electrical parts.
2. The warranty begins on the date of product shipment from the GIMA warehouse to the buyer.
3. In case of disputes, the date indicated on the “transport document” attached to the goods shall be deemed valid.
4. The warranty only covers the sending of Product spare parts to the buyer or, in the event of GIMA considering the replacement of spare parts not feasible, the replacement of the entire product, after fabrication faults have been properly ascertained at the undisputable judgement of GIMA. The warranty does not therefore cover any other costs or expenses (including, by way of example but without limitation, labour costs, packaging costs and transport costs, etc.).
5. The guarantee does not include the components subject to normal wear, such as halogen bulbs, LEDs, fuses, relays, ball bearings, etc.
6. The warranty does not cover:
 - malfunctions due to failure to comply with the instruction manuals;
 - malfunctions due to installation and/or maintenance errors;
 - malfunctions or faults caused by carelessness, negligence, incorrect use or other causes not attributable to GIMA;
 - malfunctions or faults due to the fact that the electrical system of the premises where the machine is installed is not in compliance with International or local standards for electrical systems in premises used for medical purposes and similar standards.
7. GIMA shall repay direct damages suffered by the buyer and which are documented as attributable to its product, caused within the warranty period, for an amount not above 40% of the net value of the product as indicated on the buyer’s invoice. GIMA’s liability is expressly ruled out for indirect damages or consequential damages (including cases of the lamp not being used) deriving from the supply.
8. This warranty certificate replaces legal warranties for faults and non-conformities and rules out any other possible liability of GIMA originating from the supplied products.
9. The payment of any damages to persons or things due to product malfunction or faults shall be limited to the maximum amount of GIMA’s insurance coverage for civil liability.
10. The warranty shall be automatically invalidated in the event of:
 - the product having been tampered with or modified by the buyer or third parties;
 - the product having been repaired by the buyer or third parties, without following the instructions in the instruction manuals;
 - the product serial number having been cancelled, defaced or removed;
 - the buyer not being up to date with payments.
11. For jobs to be done under warranty, the buyer shall contact GIMA only.
12. The component parts replaced under warranty must only be returned to GIMA, if so requested by GIMA, carriage free and suitably packed.
13. In case of failure to return a part requested by GIMA, the cost of the component part will be charged.
14. GIMA cannot accept returns from end users or in any case from parties other than the buyer.
15. Products returned to GIMA must be complete with documentation authorising such return and another document describing the malfunction.
16. For everything not indicated on this warranty certificate, reference shall be made to the laws of Italy.
17. For all disputes deriving from or related to the orders to which this warranty certificate applies and which cannot be amicably settled between the parties, the only competent law court shall be that of Milan.

2. Product Installation

Before installing the Product, make sure that all the packages are present and in good condition, without any transport-related damage, and that the contents correspond to what is specified above.

Claims will be considered only if the seller or the forwarder are informed immediately. Each claim must be in writing. Goods are always carried at the buyer's risk.

Keep the original package in case the lamp must be sent back.

2.1 Installation mobile version

1. Insert the lamp into the upper hole of the pipe.
2. Screw down the knob, taking care of the thread
3. Connect the power cable plug to the network line (please check that the network line is equipped with the ground cable).



2.2 Installation wall version (S/12 MED fixing)

1. Fix the clamp S/12 MED on the wall using 3 expansion screws.
2. Insert the lamp into the upper hole of the wall clamp S/12MED.
3. Follow points 2 and 3 of paragraph 2.1.

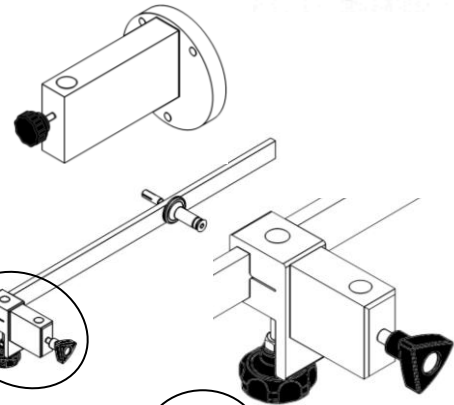

2.3 Installation wall version (rail bar fixing)

1. Fix the rail bar supports using 2 expansion screws.
2. Put the clamp on the bar and tighten the handle.
3. Insert the lamp into the upper hole of the rail clamp
4. Follow points 2 and 3 of paragraph 2.1.

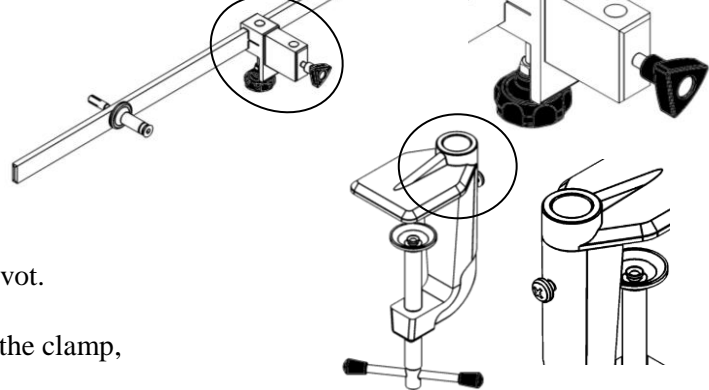

2.4 Installation table version (S11 fixing)

1. Fix the clamp S/11 to the table tighten the screwed pivot.
2. Insert the lamp into the upper hole of the table clamp
3. Screw, using a screwdriver, the screw on the back of the clamp,
4. Follow point 3 of paragraph 2.1.

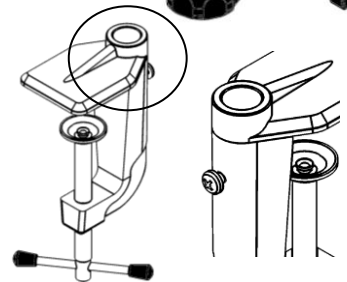

2.5 First starting.

At this point is possible to power the Product to check its correct functioning.

Follow the steps below:

- 1- Press the green switch of the base;

2.6 Installation verification and Product testing operations before use

The following prescriptions are to be considered compulsory during verification of the installation, since they prove the correct execution of all the points set out. For such reason it is necessary to tick each point when it is treated.

1. Check the suitability of the wall to the installation of the Product.
2. Check the right installation of the pivot into the clamp/stem
3. Make sure the movement mechanism works perfectly. Check the mechanical operation of the Product by directing and rotating
4. After turning on the Product, it must emit light from the reflector

Seal and signature of the installer:

	<h1>Operative Manual</h1>	MO082-IT	15/06/12
		Rev.0	Pag. 7 di 12

3. Importance of personal safety

3.1 Intended use

The Product is made to light up the area occupied by the patient undergoing diagnostic or observation, and has been designed for use in medical surgeries.

The Product correctly lights up the field of work from a minimum distance of 40cm to a maximum distance of 70cm from the point of light emission.

The Product, in compliance with the standard IEC 60601-2-41, is assessed as luminaire for diagnosis:

- Luminaire to illuminate the body of the patient locally in order to support diagnosis or treatment which could be interrupted without any hazard for the patient in case of failure of the light. (Is not intended to be used in operating rooms)

3.2 Environmental conditions.

- The Product is not suitable for use in explosion-risk areas.
- The Product is not suitable for use in the presence of inflammable mixtures of anaesthetics with air, oxygen or NO₂ (laughing gas).
- During operation, the ambient temperature must be between 10°C and 40°C.
- Relative humidity must be between 30% and 75%.
- Atmospheric pressure must be between 700 and 1060hPa.

3.3 Other secondary conditions (secondary effects)

- Do not direct the light source into the patient's and/or operator's eyes.
- Obligation to adequately protect the patient's eyes.
Failure to follow such precautions could cause glare and potential damage to the retina.
- Never place and/or hang anything on the Product.
Unless this precaution is taken, positioning will not be reliable and the danger exists of such objects falling in the operating area.
- Never hang on the Product with the body weight of a person.
Unless this precaution is taken, mechanical parts of the Product could be damaged.
- Never cover the head of the Product during operation.
Failure to comply could prevent heat exchange with the environment and the Product could overheat.
- Avoid knocking the rocker arms and Product head.
A violent knock could damage the Product and pieces of paint could chip off and fall onto the operating field in the patient area.

4. Description of the operations

The Product requires no keyboard for its functioning. The turning on is controlled by the switch "I-O" situated on the base of the Product.

5. Cleaning and disinfection

5.1 Cleaning the Product

Switch the Product off by means of the removing of plug, and make sure it cannot be switched back on.

Protect the Product against water spray and do not clean it/disinfect it with liquids.

Leave the lamp body to cool down. Only clean the lamp body when it is cold.

Clean with appropriate detergent with low alkaline content and chlorine free.

Do not use abrasive products, petrol, paint thinners, alkaline detergents, acids, containing alcohol or aldehydes;

Dose the detergents so no liquids penetrate into the lamp bodies and into the support arm system.

Clean the Product with a damp but not wet cloth.

5.2 Disinfecting

Switch the Product off by means of the removing of plug and make sure it cannot be switched back on.

Protect the Product against water spray and do not clean it/disinfect it with liquids.

Leave the lamp body to cool down. Only disinfect the lamp body when it is cold.

Disinfectants can contain substances which are harmful for the health: only use disinfectants in accordance with the rules on hygiene established by the hospital.

The Product operator must comply with the rules established by the national commission for hygiene and disinfection.

To prevent damaging parts in stainless steel or aluminum, only use disinfectants which are chlorine and halogen free.

To prevent the plastic parts becoming fragile, use only disinfectants with low alcohol content.

Dose the disinfectants so no liquids penetrate inside the lamp bodies and into the support arm system.

Disinfect the Product with a damp but not wet cloth.

Each Product, over time, is subject to a certain amount of wear. Product safety and operation must therefore be checked during inspection and maintenance intervals.

6. Adjustments

6.1 Yearly inspections by the operator

Keep to the yearly inspection schedules and inspect the product according to IEC 62353 standard.

6.2 Repairs

The Product must only be opened and repaired by a technician who has attended a course on the Product organized by the manufacturer or by a qualified technician in possession of the necessary technical skills.

6.3 Adjustments

The Product is sold already balanced and does not require further adjustment. In the event of the Product becoming stiff or loose over time, contact the service center.

6.4 Troubleshooting

n	Problem	Solution
1	The Product does not switch on	Check the voltage at input and output of power supply. Substitute the bulb if there is presence of tension.
2	The Product does not remain in position	Contact the service center.
3	The light flickers	Check the bulbs
4	The light beam is not on focus	Contact the service center.

6.5 Bulb substitution

After checking that the lamp is switched off, unplugged with cooled bulb and protection screen, it is possible to unscrew the 6 screws settled under the reflector. In this way you can change the bulbs (2x20W-12V GU5,3).

Reassemble all the parts as per original state.

6.6 Routine maintenance

n	Period	Job
1	Once a year	Inspect all the lamp joints and make sure they are not hard to move. If Product does not maintain the position or is hard in movements, contact the service center.
2	Once a year	Make sure the retention screws are tightened properly. If these are not properly fastened, adequately tighten.
3	Once a year	Check the condition of the Product paint. Make sure there are no paint pieces that could fall on the operating field.

7. Technical data

Technical data	SOLESUD
Illumination Ec at a distance of 50cm [Lux] $\pm 10\%$	40.000
Data on electrical connection	
Primary alternating voltage [Volt ac]	230-240
Frequency [Hz]	50-60
Absorbed power [W]	40
Light source	N°2 Lamp. 2X20W 12V GU 5.3 10°
Light source duration [h] (this datum can vary according to voltage peaks and the frequency of use)	5.000
General data	
Color	RAL 9003
Directive	2007/47/CE
Standard	EN 60601-1 e EN 60601-2-41
Electrical safety class	Class I
Protection against direct and indirect contacts	B-type device
Dimensions	
Overall dimension [mm]	1000x350x150
Lamp weight [Kg]	3
Certificate	
	Complying with directive 93/42/EEC (included 2007/47/EC)

All lighting values are subject to a tolerance of $\pm 6\%$ due to manufacturing and metrological reasons.

8. Electrical diagram

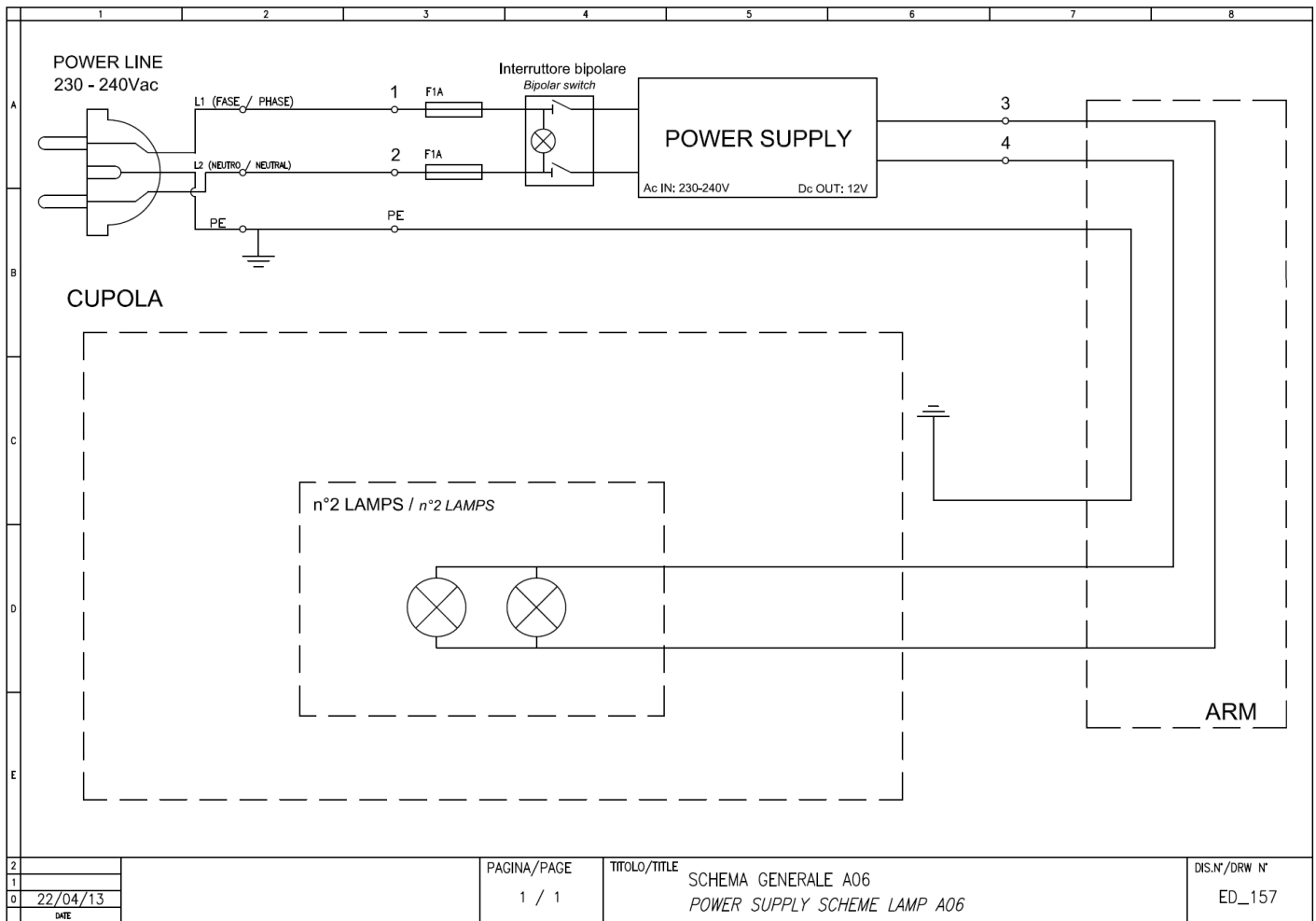

9. EMC declaration

The Product has been tested in accordance to EN60601-1-2 to ensure proper electromagnetic compatibility. Portable and mobile RF-communications equipment can affect the Product. Other products used in the vicinity of Product should also comply with this standard.

The Product is intended for use in the electromagnetic environment specified below. The customer or the user of the Product should assure that these are used in such an environment.

Emissions test	Compliance	Electromagnetic environment-guidance
RF emissions CISPR 11	Group 1	The Product uses RF energy only for its internal function. Therefore, its RF emissions are very low and are not likely to cause any interference in nearby electronic equipment.
RF emissions CISPR 11	Class A	The Product is suitable for use in all establishments other than domestic, and may be used in domestic establishments and those directly connected to the public low-voltage power supply network that supplies buildings used for domestic purposes, provided the following warning is heeded: Warning: This equipment/system is intended for use by healthcare professionals only. This equipment/system may cause radio interference or may disrupt the operation of nearby equipment. It may be necessary to take mitigation measures, such as re-orienting or relocating the Product or shielding the location
Harmonic emissions IEC 61000-3-2	Class A	
Voltage fluctuations/ flicker emissions IEC 61000-3-3	Compliance	

Immunity test	IEC 60601-1-2 test level	Compliance level	Electromagnetic environment-guidance
Electrostatic discharge (ESD) IEC 61000-4-2	+/- 6 kV contact +/- 8 kV air	+/- 6 kV contact +/- 8 kV air	Floors should be wood, concrete or ceramic tile. If floors are covered with synthetic material, the relative humidity should be at least 30%
Electrical fast transient / burst IEC 61000-4-4	+/- 2 kV for power supply unit +/- 1 kV for input/output lines	+/- 2 kV for power supply lines +/- 1 kV for input/output lines	Mains power quality should be that of a typical commercial or residential environment.
Surge IEC 61000-4-5	+/- 1 kV differential mode +/- 2 kV common mode	+/- 1 kV differential mode +/- 2 kV common mode	Mains power quality should be that of a typical commercial or hospital environment.
Voltage dips, short interruptions and voltage variations on power supply input lines IEC 61000-4-11	<5% U_T (>95% dip in U_T) For 0,5 cycle 40% of U_T (60% dip in U_T) For 5 cycles 70% of U_T (30% dip in U_T) For 25 cycles <5% U_T (>95% dip in U_T) For 5 sec	<5% U_T (>95% dip in U_T) For 0,5 cycle 40% of U_T (60% dip in U_T) For 5 cycles 70% of U_T (30% dip in U_T) For 25 cycles <5% U_T (>95% dip in U_T) For 5 sec	Mains power quality should be that of a typical commercial or hospital environment. If the user of the Product requires continued operation during power mains interruptions, it is recommended that the Product be powered from an uninterruptible power supply or battery.
Power frequency (50/60Hz) magnetic field IEC 61000-4-8	3 A/m	3 A/m	Power frequency magnetic fields should be at levels characteristic of a typical location in a typical commercial or hospital environment.

NOTE U_T is the a.c. main voltage prior to application of the test level.

Immunity test	IEC 60601 test level	Compliance level	Electromagnetic environment-guidance
Conducted RF IEC 61000-4-6	3 Vrms 150 kHz to 80 MHz	3 Vrms	<p>Portable and mobile RF communications equipment should be used no closer to any part of the Product, included cables, than the recommended separation distance calculated from the equation applicable to the frequency of the transmitter.</p> <p>Recommended separation distance</p> $d = 1,2\sqrt{P} \quad 150 \text{ KHz to } 80 \text{ MHz}$ $d = 1,2\sqrt{P} \quad 80 \text{ MHz to } 800 \text{ MHz}$ $d = 2,3\sqrt{P} \quad 80 \text{ MHz to } 2,5 \text{ GHz}$ <p>where P is the maximum output power rating of the transmitter in watts (W) according to the transmitter manufacture and <i>d</i> is the recommended separation distance in meters (m). Field strengths from fixed transmitters, as determined by an electromagnetic site survey, should be less than the compliance leave in each frequency range. Interference may occur in the vicinity of equipment marked with the following symbol.</p> 
Radiated RF IEC 61000-4-3	3 V/m 80 MHz to 2,5GHz	3 V/m	

Recommended separation distance between portable an mobile RF communications equipment and the Product

The Product is intended for use in an electromagnetic environment in which radiated RF disturbances are controlled. The customer or the user of the Product can help prevent electromagnetic interference by maintaining a minimum distance between portable and mobile RF communications equipment (transmitters) and the Product as recommended below, according to the maximum output power of the communications equipment.

Rated maximum output power of transmitter W	Separation distance according to frequency of transmitter m		
	150 kHz to 80 MHz $d = 1,2\sqrt{P}$	80 MHz to 800 MHz $d = 1,2\sqrt{P}$	800 MHz to 2,5 GHz $d = 2,3\sqrt{P}$
0.01	0.12	0.12	0.24
0.1	0.38	0.38	0.73
1	1.2	1.2	2.3
10	3.8	3.8	7.3
100	12	12	23

For transmitters rated at a maximum output power not listed above, the recommended separation distance *d* in meters (m) can be estimated using the equation applicable to the frequency of the transmitter, where *P* is the maximum output power rating of the transmitter in watts (W) according to the transmitter manufacturer.

Note 1: at 80 MHz and 800 MHz, the separation distance for the higher frequency range applies.

Note 2: These guidelines may not apply in all situations. Electromagnetic propagation is affected by absorption and reflection from structures, objects an people.