

**MD**

USER MANUAL

# LUXIFLEX

## EXAMINATION LAMP

LUXIFLEX LED  
LUXIFLEX LED PLUS

LUXIFLEX SENSOR  
LUXIFLEX SENSOR PLUS

LUXIFLEX HAL

**mimsal**

F3P31  
Rev. 01  
20.06.2022

Dear user, we encourage you to read this manual carefully before using the product.

The manufacturer states that this product complies with Annex I (General safety and performance requirements) of (EU) REGULATION 2017/745 on medical devices, amended and integrated.

This manual's content may be modified in part or in whole by MIMSAL without prior notice in order to make changes and improvements.

MIMSAL has a Customer Support service available.

Your team:

**MIMSAL**

MIMSAL TRADE S.L.

C/ Mollet, 17

Polígono Industrial Palou Nord

08401 – Granollers (Barcelona) SPAIN

Tel. +34 930 139 860













[mimsal@mimsal.com](mailto:mimsal@mimsal.com)

[www.mimsal.com](http://www.mimsal.com)





# TABLE OF CONTENTS

1. Safety instructions	5
2. Brief description	6
3. Installation and supports	7
3.1 Trolley Stand	8
3.2 AH Table Clamp	9
3.3 Wall B Support	10
3.4 Rail Plus Bracket	11
3.5 Extension arm	12
4. Operation of the lighting unit	13
4.1 Check before each use	13
4.2 Operation of the lighting unit head	13
4.3 Flexible arm measurement details	13
5. Safety functions	14
5.1 Voltage drop	14
5.2 Power cuts	14
5.3 Electrical malfunction	14
6. Cleaning/Disinfection	14
6.1 General safety instructions	14
6.2 Cleaning	14
6.3 Disinfection	15
7. Maintenance	15
7.1 Lighting unit support arms	15
7.2 Lighting unit head	16
7.3 Repairs	16
7.4 Adjustments	16
7.5 Troubleshooting	16
8. Recycling	16
9. Technical data	17
10. Electromagnetic Emissions	18
11. Warranty	20
12. Industrial and Intellectual Property	21
13. Confidentiality	21
14. Declaration of Conformity	22
15. Certificate ISO 9001	23
16. Certificate ISO 13485	24

## SYMBOLS

	<b>INSTRUCTIONS</b>
	<b>DECLARATION OF CONFORMITY</b>
	<b>MEDICAL DEVICE</b>
	<b>ITEM CODE</b>
	<b>BATCH NUMBER</b>
	<b>MANUFACTURING DATE</b>
	<b>NAME AND ADDRESS OF THE MANUFACTURER</b>
	<b>ELECTRONIC WASTE RECYCLING</b>
	<b>ELECTRICAL INSULATION CLASS</b> Class II
	<b>MINIMUM DISTANCE TO THE ILLUMINATED OBJECT</b>
	<b>AMBIENT TEMPERATURE</b> Shows the permitted ambient temperature of between -25°C and 70°C for transportation and storage.
	<b>HUMIDITY</b> Shows the permitted humidity values of between 10% and 75% for transportation and storage.

## SAFETY RULES

	<b>WARNING</b> Not doing so could result in serious or even fatal injuries.
	<b>CAUTION</b> Not doing so could result in minor to moderate injuries or damage.
	<b>NOTE   INFORMATION</b> Provides application tips and useful information.
	<b>FALLING OF THE LIGHTING UNIT</b> Warns about the sudden collapse of the support arm system if the maximum useful load is exceeded.
	<b>TIPPING HAZARD</b> The brackets are only designed to support the weight of the head. If additional weight is added, the unit may tip over, which could cause damage of varying degrees.

## REFERENCE AND MODEL

REF	MODEL	UDI-DI
I0104NL	LUXIFLEX LED PLUS	8436562860356
I0104AOLED	LUXIFLEX LED	8436562860011
I0104NLSR	LUXIFLEX SENSOR PLUS	8436562860417
I0104AOLEDSR	LUXIFLEX SENSOR	8436562860400
I0104AO	LUXIFLEX HAL	8436562860004

## 1. SAFETY INSTRUCTIONS



Check the operating instructions when handling the device.

This lighting unit is a Class I medical device according to (EU) Regulation 2017/745 on medical devices.

### ENVIRONMENT

1. This device is not designed to be operated in potentially explosive areas!
2. Do not use it in oxygen-enriched areas!
3. Do not use it near flammable anesthetic gases!
4. Do not place it close to strong magnetic fields! e.g. Magnetic resonance systems.
5. Do not cover the top of the lamp head! Risk of overheating!

### ELECTRONIC SAFETY

1. Only use the built-in power source unit!
2. The lighting unit does not include a fail-safe power source or an emergency battery!
3. In the event of a power cut, the lighting unit will shut off completely!
4. Short black-outs are possible in the event of external EMC interference!
5. To switch off the lamp completely, the power plug must be removed from the outlet or the live outlet must be disabled using a separate switch.

### MAINTENANCE AND RESPONSABILITY

1. Installation and electrical maintenance work must only be carried out by qualified personnel!
2. The manufacturer is not responsible for any damage caused by improper use!
3. The final user is responsible for the product's installation and MIMSAL accepts no responsibility.
4. The manufacturer is responsible for the safety of the lamp only if repairs and modifications are carried out by the manufacturer itself or by a company that ensures compliance with safety rules, using original replacement parts!

Prior to each use, make sure that the lamp is in perfect technical condition.

## 2. BRIEF DESCRIPTION

### INTENDED USERS

These operating instructions are intended for the health professionals who use, clean, and disinfect MISMAL lighting units.

### INTENDED USE

This lighting unit is intended for carrying out very meticulous work that requires a high level of precision. It is suitable for use in hospitals, medical research, laboratories, clinics, etc.

### INDICATION

The light is only intended to provide optimal visibility of the surface being examined and has no diagnostic or therapeutic effect. The light is external to the body and the device never enters into contact with patients.

### CONTRAINDICATION

The products must not be used close to strong magnetic fields.

The device must not be used in oxygen-enriched environments or in close to flammable anesthetic gases.

### RESIDUAL RISKS – RISK IN THE EVENT OF DAMAGE TO THE LIGHTING UNIT

Protect the lighting unit from knocks. Collision with other objects could result in the failure of the device and/or damage to the cover and the support arm system, causing parts to fall off.

The lighting unit does not include a fail-safe power source. A power cut will cause the device to switch off.

Do not aim the light source directly at the eyes of the patient and/or operator.

Always properly protect the patient's eyes.

Failing to comply with these precautions could cause blinding and damage to the retina.

Never place and/or hang any object on the lighting unit. If this precaution is not taken, the unit's position will be unstable and these objects could fall onto the work area.

Never hang the body weight of a person from the lighting unit. Failing to comply with this precaution could damage the structure of the device.

### INCIDENTS AND REPORTS

The user and/or the patient must notify MISMAL and the competent authority in the country if any serious incident occurs whilst using the device.

In accordance with the Medical Devices Regulation (MDR), the competent authority must be notified immediately.

### 3. INSTALLATION AND SUPPORTS

Before starting to install the device, check that the content is in good condition and that it has not been damaged or degraded during transportation.

Claims will only be accepted if the vendor or the carrier is notified immediately. All claims must be made in writing.

The goods always travel under the buyer's responsibility and at the buyer's risk.

Keep the original packaging in the event the product needs to be returned.

#### TYPES OF SUPPORT

The lighting unit may come with several different types of brackets, allowing the most suitable one to be selected for its use.

All accessories must be assembled by an authorized installer.

Do not make any modifications to the product, other than those mentioned in this user manual.

MODEL	SUPPORT
TROLLEY STAND	Rolling base with 5 wheels
AH TABLE CLAMP	Table clamp
WALL B SUPPORT	Reinforced wall B bracket
RAIL PLUS BRACKET	Bracket for mounting on an ICU rail
EXTENSION ARM	Extension arm + Reinforced wall B bracket

### 3.1 TROLLEY STAND

REF	MODEL	DESCRIPTION
09655	TROLLEY STAND 4 Kg	4 Kg rolling base
09651	TROLLEY STAND 8,8 Kg	8.8 Kg rolling base



Install the accessory without the lighting unit installed on it.

It is the customer's responsibility to ensure that the surface that it is attached to is secure and sufficiently strong.



Check regularly that the unit is still stable in order to avoid the possibility of the lighting unit falling down.



The rolling base is only designed to support the weight of the lighting unit. If additional weight is added, the unit may tip over and cause damage to the lighting unit and/or injury to the user.

#### 1. Installation and assembly

- Insert piece (2) totally into the base (3) and press down.
- Insert the legs with the wheels (4) through the base slot (3) until it completely fits, and if necessary helping with a nylon hammer.
- Fit piece 5 into the interior leg slots (4) by pressing down.
- Put the screw (7) through the washer (6) and insert the screw into piece 5 to connect the set.
- Join the pole (1) directly with the screw (7) without tightening the pole (1) with the piece (2) so as not to damage the paint.
- Hold the pole (1) firmly and turn the screw (7) with a wrench or a scanner until the whole set is tight.
- Luminaries fixation system (8). Allen number 2.

#### 2. Technical characteristics

- Length of pole: 75 cm
- Total length: 92 cm
- Base diameter: 60 cm
- Wheel diameter: 50 mm
- Number of wheels: 5
- Number of brakes: 3

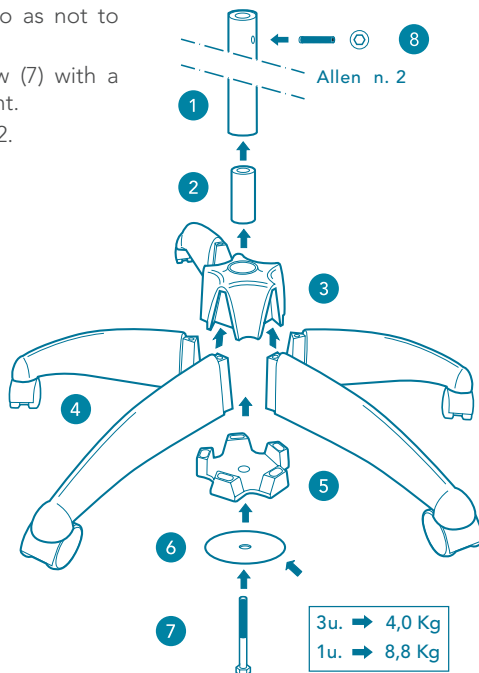



## 3.2 AH TABLE CLAMP

REF	MODEL	DESCRIPTION
B010190	AH TABLE CLAMP	Table clamp



Install the accessory without the lighting unit installed on it.

It is the customer's responsibility to ensure that the surface that it is attached to is secure and sufficiently strong.



Check regularly that the unit is still stable in order to avoid the possibility of the lighting unit falling down.



The bracket is only designed to support the weight of the lamp. If additional weight is added, this may cause damage to the lighting unit and/or injury to the user.

### Installation and assembly

- Use the handle to loosen the adjustment screw (1).
- Rest the base of the clamp on the surface of the table (2).
- Adjust the body of the clamp (3) until it is touching the edge of the table.
- Turn the handle (4) until the clamp and the table are firmly attached.
- Once the clamp is fixed and secure, position the lamp through the upper hole (5).

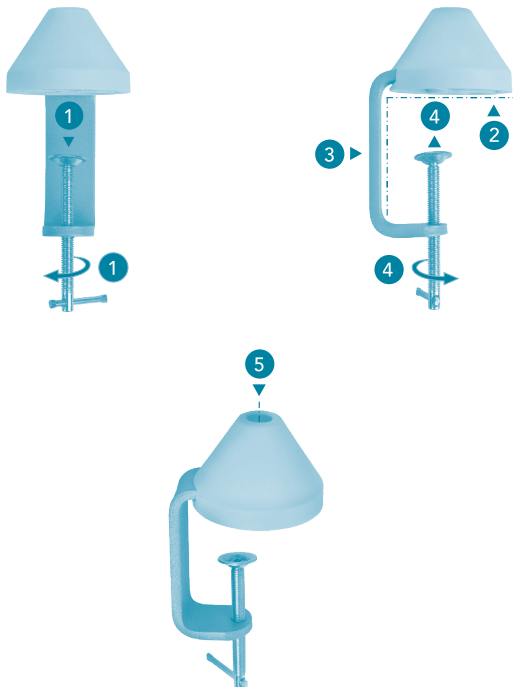

### 3.3 WALL B SUPPORT

REF	MODEL	DESCRIPTION
B0101800	WALL B SUPPORT	Reinforced wall B bracket. 7 cm shaft-wall separation.



Install the accessory without the lighting unit installed on it.

It is the customer's responsibility to ensure that the surface that it is attached to is secure and sufficiently strong.



Check regularly that the unit is still stable in order to avoid the possibility of the lighting unit falling down.



The bracket is only designed to support the weight of the lamp. If additional weight is added, this may cause damage to the lighting unit and/or injury to the user.

#### Installation and assembly

- Check that the wall is sufficiently hard-wearing and flat.
- Use the bracket to mark the holes on the wall with the help of a pencil (1).
- Drill holes and put the plugs into the wall (1).
- Position the wall support, lining it up with the location of the holes (2).
- Tighten the screws until the assembly, the guide separator and the screw are firmly attached (2).
- Once the support is fixed and secure, position the lamp through the upper hole (3).

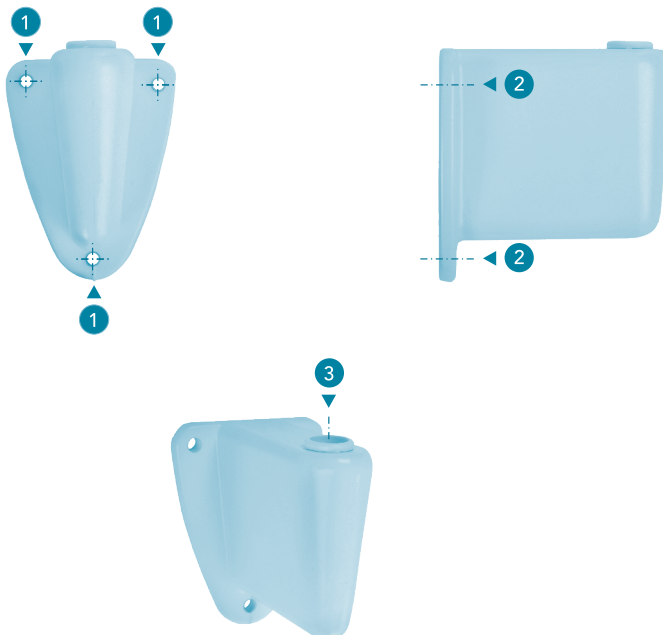

### 3.4 RAIL PLUS BRACKET

REF	MODEL	DESCRIPTION
82026	RAIL PLUS BRACKET	Bracket for mounting on an ICU rail.



Install the accessory without the lighting unit installed on it.

It is the customer's responsibility to ensure that the surface that it is attached to is secure and sufficiently strong.



Check regularly that the unit is still stable in order to avoid the possibility of the lighting unit falling down.



The bracket is only designed to support the weight of the lamp. If additional weight is added, this may cause damage to the lighting unit and/or injury to the user.

#### Installation and assembly

- Loosen the adjustment screw via the wing screw (1).
- Fit the upper part of the support to the rail (2).
- The interior body of the support needs to be touching the rail (2).
- Tighten the wing screw until the support and the rail are firmly attached (3).
- Once the support is fixed and secure, position the lamp through the upper hole (4).

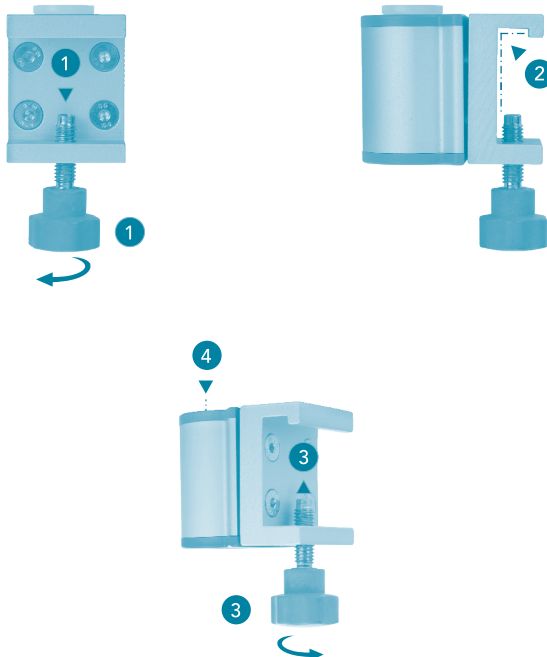

### 3.5 EXTENSION ARM

REF	MODEL	DESCRIPTION
B0101S0	EXTENSION ARM	Extension arm including Wall B Bracket. Provides an additional 40 cm, with horizontal rotation along both axes.



Install the accessory without the lighting unit installed on it.

It is the customer's responsibility to ensure that the surface that it is attached to is secure and sufficiently strong.



Check regularly that the unit is still stable in order to avoid the possibility of the lighting unit falling down.



The bracket is only designed to support the weight of the lamp. If additional weight is added, this may cause damage to the lighting unit and/or injury to the user.

#### Installation and assembly

- Check that the wall is sufficiently hard-wearing and flat.
- Use the bracket to mark the holes on the wall with the help of a pencil (1).
- Drill holes and put the plugs into the wall (1).
- Position the wall support, lining it up with the location of the holes (2).
- Tighten the screws until the assembly, the guide separator and the screw are firmly attached (2).
- Once the wall bracket is fixed and secure, position the end of the arm in the upper hole of the support (3).
- Insert the shaft of the luminaire into the hole located at the other end of the extension arm (4).
- Turn the extension arm's side screw in order to secure the luminaire (5).

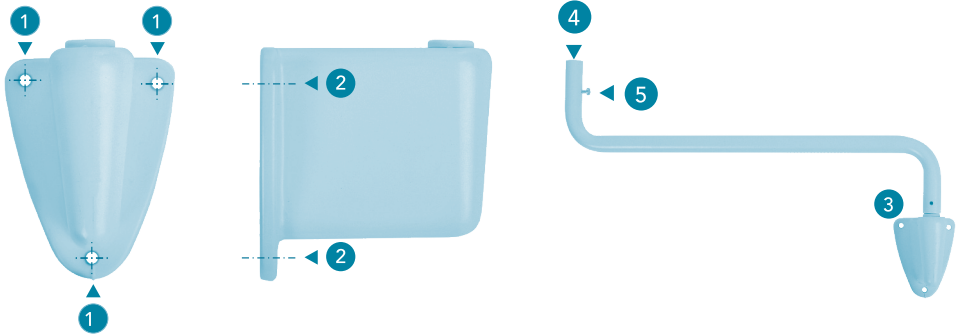

## 4. OPERATION OF THE LIGHTING UNIT

### 4.1 CHECK BEFORE EACH USE

1. Check if the unit is visibly deformed. If any deformities are detected, contact the Customer Support Department immediately.
2. Make sure the lamp is in the required hygienic conditions for use.
3. Always check the correct operation of the whole unit before turning it on. The unit must move in every degree of motion whilst verifying the main function and the control system.



Do not use the unit if there are any doubts about its electrical safety or static and dynamic stability.

### 4.2 OPERATION OF THE LIGHTING UNIT HEAD

Lighting unit with simple and ergonomic operation for intuitive handling.

For LUXIFLEX LED, LUXIFLEX LED PLUS and LUXIFLEX HAL:

- Find the switch at the base of the flexible arm.
- Select the switch position. 1 (On) | 0 (Off).
- Move the arm position to get the desired distance and lighting.

For LUXIFLEX SENSOR and LUXIFLEX SENSOR PLUS:

- Find the sensor at the base of the flexible arm.
- Versions:
  - Standard ON | OFF version: pass your hand at least 8 cm from the sensor to turn it on and off.
  - DIMMABLE version: pass your hand at least 8 cm from the sensor.

Options:

- 1st pass: for 50% illumination.
- 2nd pass: maximum illumination (100%).
- 3rd pass: to switch off the device.

Version available upon request.

- Move the flexible arm position to get the desired distance and lighting.

### 4.3 FLEXIBLE ARM MEASUREMENT DETAILS

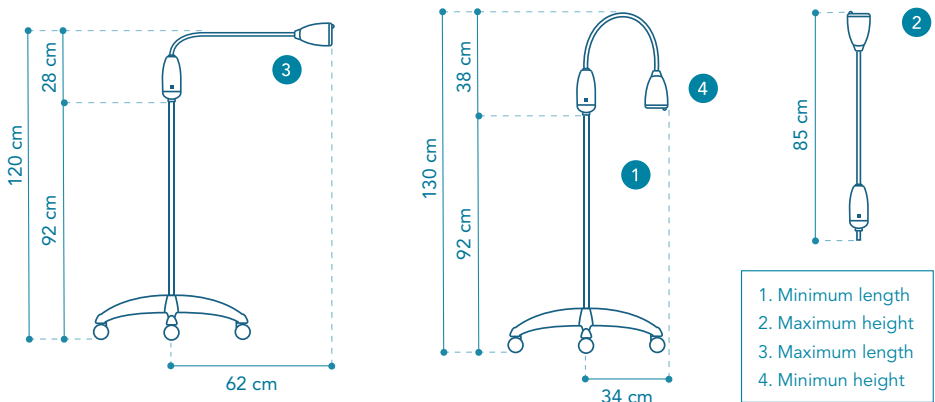

## 5. SAFETY FUNCTIONS

### 5.1 VOLTAGE DROP



In the event of a network voltage drop, the light will automatically switch off.

### 5.2 POWER CUTS



In the event of a total power cut, the light will switch off. As soon as voltage is reestablished on the network, it can be turned on again using the most recent established parameters.

### 5.3 ELECTRICAL MALFUNCTION



**NOTE:** In the event of this error, please contact the technical service.

## 6. CLEANING / DISINFECTION

### 6.1 GENERAL SAFETY INSTRUCTIONS

1. Disconnect the unit from the network before disinfecting it.
2. Never use an aerosol cleaner and/or disinfectant.
3. Do not spray liquid into sockets or slits on the unit or allow liquid to get into them.
4. Apply the cleaner by wetting a cloth, never by applying it directly to the device.



**WARNING: ELECTRICAL SHOCK**

The lighting units may transmit electricity and must be handled carefully during cleaning and disinfection.

### 6.2 CLEANING

#### SAFETY

Check the general safety instructions.

#### RECOMMENDED CLEANING

1. Use a mild soap solution as a cleaning agent.
2. Thoroughly clean the surfaces with a dampened cloth, adding a bit of mild soap solution if necessary.
3. Finally, thoroughly dry the exterior surface with a clean soft cloth (anti-static if necessary).



**WARNING: RISK OF INFECTION AND CONTAMINATION OF PATIENTS**

Solvents could corrode the plastics. Strong acids, alkalis, and agents that contain more than 60% alcohol could turn plastics brittle. Damaged parts could fall into open wounds.

## 6.3 DISINFECTION

### SAFETY

Check the general safety instructions.

### DISINFECTION PROCESS

The disinfection process is done using a cloth. The hygiene guidelines and safety measures for the disinfection processes to be used must be defined by the operator.

We recommend using MELISEPTOL disinfectant made by Braun Melsungen and/or "neoform MED rapid" made by Dr. Weigert. Follow all of the protection measures. Respect the manufacturer's instructions and follow the hygiene guidelines.



Disinfect surfaces every working day! Disinfect all of the affected surfaces immediately after any contamination by potentially infectious material (e.g.: blood, secretion or excrement).



Contact your hygiene specialist to coordinate the disinfectant and the proper procedures with your internal requirements! Always follow the internal disinfection plan!



#### WARNING: HEALTH HAZARD

Disinfectants may contain harmful substances that could injure the skin or eyes or damage respiratory organs if inhaled.

## 7. MAINTENANCE

Medical devices must undergo regular cycles of maintenance and review. This is fundamental for complying with safety measures.

See the reference in the IEC 62353 standard.

The medical device's manufacturer is responsible for defining the regular safety measures. The operator is responsible for implementing these measures.



**NOTE:** Always disconnect the device from the power source before doing any maintenance or inspection work to prevent the device from turning on involuntarily.

### 7.1 LIGHTING UNIT SUPPORT ARMS

All brackets must be checked by the operator for the following points:

- Every 6 months:
  1. Deformations of the bracket system.
  2. Cracks in plastic pieces.
  3. Damage to the paint.
- Every year:
  1. A detailed inspection of the bracket system, such as the clamping force of the spring arm, the fastening of the bracket etc.
  2. Extensive operational test, including the ease of movement of the joints.
  3. Electrical safety tests.

**WARNING: ELECTRICAL SHOCK**

Disconnect the unit from the power source during the whole of the checking process.

## 7.2 LIGHTING UNIT HEAD

The following inspections/maintenance must be carried out:

1. Check for any possible anomalies, cracks, deformations in plastic pieces and seals.
2. Carry out electrical safety tests.
3. Extended operational test.
4. Damage to the paint.

## 7.3 REPAIRS

The following indications must be followed:

- The product may only be opened and repaired by the manufacturer. Contact the Customer Support department if necessary.
- It is totally prohibited to modify the device in any way.

\* (See Warranty Section).

## 7.4 ADJUSTMENTS

The product is sold fully calibrated and does not require any additional adjustments.

If the product becomes unstable over time and cannot maintain its position, please contact the Customer Support department.

## 7.5 TROUBLESHOOTING

Contact the Customer Support department in the following cases:

- The device does not operate.
- The product does not maintain its position.
- The light flashes.
- The light beam does not focus.

## 8. RECYCLING

After the useful life of the unit has come to an end, the device must be taken out of service and properly cleaned and disinfected for subsequent recycling. For its correct disposal, please contact an authorized recycling company.



**NOTE:** Do not dispose of the product with the usual domestic waste.



Take all the disinfection and/or sterilization measures before disposing of the device so as to not contaminate the environment.



## 9. TECHNICAL DATA

PHOTOMETRIC AND ELECTRICAL DATA	LUXIFLEX LED	LUXIFLEX LED PLUS	LUXIFLEX SENSOR	LUXIFLEX SENSOR PLUS	LUXIFLEX HAL
Light Source	LED 6W 15°	LED 10W 14°	LED 6W 15°	LED 10W 14°	Halogen 35W 10°
Number of LEDs	3	4	3	4	N/A
Illumination at 50 cm	15.000 Lux	35.000 Lux	15.000 Lux	35.000 Lux	35.000 Lux
Ø Illuminated 50cm	13 cm				
IP	20				
Color temperature	4.500°K				3.000°K
Color rendering	> 80%	97%	> 80%	97%	100%
Useful life	50.000 h				5.000 h
Protection Class	Class II				
Voltage	100/240 V				220/240 V
Frequency	50/60 Hz				
Plugs available	A, B, F, G, I				F, G, I
Dimmable	NO		YES (Optional)		NO

### ENVIRONMENTAL CONDITIONS FOR OPERATION

Ambient temperature	10 °C a 40 °C
Relative Humidity (without condensation)	30% a 75%
Atmospheric Pressure	700hPa a 1060hPa

### ENVIRONMENTAL CONDITIONS FOR STORAGE AND TRANSPORTATION

Ambient temperature	-25 °C a 70 °C
Relative Humidity (without condensation)	10% a 75%
Atmospheric Pressure	500hPa a 1060hPa

PHYSICAL CHARACTERISTICS	LUXIFLEX LED	LUXIFLEX LED PLUS	LUXIFLEX SENSOR	LUXIFLEX SENSOR PLUS	LUXIFLEX HAL
Box Dimensions	515 x 160 x 90 mm				
Gross Weight	1,66kg		1,72kg		1,60kg
Lighting unit Net Weight	1,18kg		1,24kg		1,12kg
Flexible Arm Length (Gooseneck)	700mm (500 Flexible + 200 Fixed)				
Head Dimensions	150 x Ø80 mm				
Protective Glass	N/A				YES
Color	White				

\* All of the lighting units include the AH TABLE CLAMP mounting accessory by default.

\* The gross weight of the lighting unit includes the net weight of the AH TABLE CLAMP accessory.

REF	MODEL	GROSS WEIGHT	NET WEIGHT	BOX DIMENSIONS
B0101800	WALL B SUPPORT	0,25 KG	0,20 KG	91 x 221 x 122 mm
B010190	AH TABLE CLAMP	0,37 KG	0,29 KG	91 x 221 x 122 mm
82026	RAIL PLUS BRACKET	0,24 KG	0,19 KG	115 x 175 x 75 mm
09651	TROLLEY STAND 8,8 kg	9,18 KG	8,56 KG	160 x 160 x 780 mm
09655	TROLLEY STAND 4 kg	4,71 KG	4,10 KG	160 x 160 x 780 mm
B010150	EXTENSION ARM	0,74 KG	0,56 KG	160 x 520 x 90 mm

## 10. ELECTROMAGNETIC EMISSIONS

All electronic devices for medical use must comply with the requirements of the IEC 60601-1-2 standard.

Likewise, it is mandatory to respect the precautions, the information in the Electromagnetic Compatibility (EMC) guide included in this manual and the verification of all medical devices in simultaneous operation to ensure the electromagnetic compatibility and the coexistence of all other medical devices before undertaking a surgical procedure.

### MANUFACTURER DIRECTIVES AND DECLARATION – ELECTROMAGNETIC EMISSIONS

Our devices are designed to be used in an ELECTROMAGNETIC ENVIRONMENT as specified below. The user must ensure that the units can operate in that environment.

**NOTE:** Home health care settings have higher immunity requirements than professional medical care facilities. Therefore, the interference immunity requirements for professional medical care centers are included here.

EMISSIONS TESTS STANDARD BASIC EMC	COMPLIANCE	ELECTROMAGNETIC ENVIRONMENT
Conducted RF Emissions CISPR11	Group 1	The device only uses RF energy for its internal operations. Its RF emissions are therefore very low and are unlikely to cause interferences with nearby electronic equipment.
Radiated RF Emissions CISPR11	Class B	The device is suitable to be used in all establishments, including domestic establishments and those connected directly to the public low-voltage power mains that supply buildings used for domestic purposes.
Harmonic Distortion IEC (EN) 61000-3-2	Class A	
Voltage Fluctuations and Flashing IEC (EN) 61000-3-3		

## MANUFACTURER DIRECTIVES AND DECLARATION – ELECTROMAGNETIC IMMUNITIES

Our devices are designed to be used in an ELECTROMAGNETIC ENVIRONMENT as specified below. The user must ensure that the units can operate in that environment.

**NOTE:** Home health care settings have higher immunity requirements than professional medical care facilities. Therefore, the interference immunity requirements for professional medical care centers are included here.

STANDARD BASIC EMC IMMUNITIES TEST	TEST LEVEL IEC 60601	COMPLIANCE	ELECTROMAGNETIC ENVIRONMENT
Electrostatic Discharge (ESD) IEC (EN) 61000-4-2	±8kV Contact  ±15kV Air	±8kV Contact  ±15kV Air	Floors must be made from wood, concrete or ceramic tiles.  If the floors are covered in synthetic material, the relative humidity must be at least 30%.
Electrical Fast Transients (bursts) IEC (EN) 61000-4-4	±2kV for power lines  ±1kV between phases	±2kV for power lines  ±1kV between phases	The quality of the electrical supply network must be equivalent to that of a commercial or hospital setting.
Mains surge IEC (EN) 61000-4-5	±2kV between phases and earth  ±1kV for input/output/earth lines	±2kV between phases and earth  ±1kV for input/output/earth lines	The quality of the electrical supply network must be equivalent to that of a commercial or hospital setting.
Voltage Drops IEC (EN) 61000-4-11	0% UT (100% drop in UT); 0.5 cycles  40% UT (60% drop in UT); 10 cycles  0% UT (100% drop in UT); 5s	0% UT (100% drop in UT); 0.5 cycles  40% UT (60% drop in UT); 10 cycles  0% UT (100% drop in UT); 5s	The quality of the electrical supply network must be equivalent to that of a commercial or hospital setting. If the device user requires continued use during power cuts, we recommend powering the device with a different power source or battery.
Magnetic Field at Industrial Frequency IEC (EN) 61000-4-8	30 A/m	30 A/m	Magnetic fields at industrial frequency must be those of a typical hospital or commercial setting.
Radiated Radiofrequency IEC (EN) 61000-4-3	10 V/m  80MHz - 6GHz	10 V/m  80MHz - 6GHz	The distance between portable or mobile radiofrequency communication equipment and the device, including cables, must not be less than the recommended separation distance, which is calculated using the applicable equation for the transmitter frequency.
Conducted Radiofrequency IEC (EN) 61000-4-6	10V  150kHz - 100MHz	10V  150kHz - 100MHz	Recommended separation distance: $d = 1,2\sqrt{P}$ ; < 80MHz $d = 1,2\sqrt{P}$ ; de 80MHz - 800MHz $d = 2,3\sqrt{P}$ ; de 800MHz - 2,7GHz  $P$ is the maximum rated power output of the transmitter in watts (W) and $d$ is the recommended separation distance in meters (m).

**NOTE 1:** UT is the AC network voltage before applying the test level.

**NOTE 2:** The upper frequency range is applied at 80MHz and 800MHz.

**NOTE 3:** These directives may not be applicable in all situations. Electromagnetic propagation is affected by the absorption and reflection of structures, objects and people.

## 11. WARRANTY

The Buyer must report any visible damage to the Products within a maximum of forty-eight (48) hours of receipt. After this time, MIMSAL will not be liable for the apparent damages the products may have and that have not been reported by Buyer.

MIMSAL offers a guarantee of five (5) years from delivery on any defects that the Products may have.

It will be understood that the Products have a defect when, without having suffered any damage after their delivery, they are not suitable for use or they have a quality or performance level that is inferior to that stated in their technical specifications. It will be up to the Buyer to prove that the Product is non-compliant.

To exercise the warranty, the Buyer must inform MIMSAL in writing by sending an email to [mimsal@mimsal.com](mailto:mimsal@mimsal.com), indicating the defect, identifying the Product, the Batch number, the REF number of the purchase order and a photograph of the Product. This email must be sent within a maximum of ten (10) days of detecting the Product defect.

Upon receipt of this email, MIMSAL will try to see if it is possible to resolve the incident remotely, in which case it will respond to the Buyer with instructions on how to proceed or, conversely, if the Product must be sent to MIMSAL to be examined and, if necessary, repaired or replaced. The shipment of Products (including disassembly, transport, taxes, etc.) will be at the expense of the Buyer.

The warranty will consist of the repair or replacement of the Products, its elements and/or installation that are defective or deficient, or a refund for the amount of the price at MIMSAL's discretion.

The warranty granted to the Buyer by MIMSAL will not be applicable in the following cases:

- When the Products have not been used, stored, conserved, installed, handled, etc. in accordance with the instructions given by MIMSAL.
- When the Products have been manipulated, altered or modified by third parties.
- When the origin of the defects is not due to issues related to their manufacture or defects in the quality of their components.
- In the case of damage and/or defects suffered due to wear and tear from normal use of the Products.

The defective Products and/or materials that have been replaced by others will remain the property of MIMSAL. The warranty established in this clause is exclusive and replaces all other warranties related to the Products.

## 12. INDUSTRIAL AND INTELLECTUAL PROPERTY

All of the industrial and intellectual property rights relating to the Products, as well as the designs, texts, labeling, images, graphics, brands, technical documentation, manuals, etc., are the exclusive property of MIMSAL and the Buyer acknowledges and accepts this. In any case, these rights are protected by the regulations governing intellectual and industrial property, meaning it is forbidden to reproduce, modify, distribute and/or manipulate them.

Also, the Buyer will collaborate with MIMSAL in the maintenance of said intellectual and industrial property rights, immediately notifying MIMSAL of any action or circumstance that may infringe them and refraining from carrying out such actions.

The Buyer is obliged to abstain from registering in their name or in the name of third parties, brands or trademarks that are identical or similar to those used by MIMSAL or that could cause confusion for customers regarding the identity or character of MIMSAL or of the Products.

It is expressly forbidden to use the Products or any element of Industrial or Intellectual Property related to the Products that are the property of MIMSAL in such a way that may constitute a violation of the rights protected by law and specifically by any applicable legislation on Industrial and Intellectual Property.

MIMSAL reserves all actions that may protect it in the defense of its interests and rights.

## 13. CONFIDENTIALITY

All of the industrial and intellectual property rights relating to the Products, as well as the designs, texts, labeling, images, graphics, brands, technical documentation, manuals, etc., are the exclusive property of MIMSAL and the Buyer acknowledges and accepts this. In any case, these rights are protected by the regulations governing intellectual and industrial property, meaning it is forbidden to reproduce, modify, distribute and/or manipulate them.

## 14. DECLARATION OF CONFORMITY

MD

MIMSAL

n° 2103

## DECLARACIÓN UE DE CONFORMIDAD

### EU DECLARATION OF CONFORMITY

FABRICANTE PRODUCTO  
PRODUCT MANUFACTURER

MIMSAL TRADE S.L.

Dirección  
Address

C. Mollet 17, Polígono Industrial Palou Nord  
08401 Granollers (Barcelona)  
Spain

DECLARAN BAJO SU RESPONSABILIDAD QUE EL PRODUCTO  
DECLARE UNDER THEIR RESPONSIBILITY THAT THE PRODUCT

Nombre del producto - BASIC UDI-DI  
Product name - BASIC UDI-DI

LUXIFLEX 843656286LUXTK

Tipo  
Type

LÁMPARA DE RECONOCIMIENTO  
EXAMINATION LAMP

Referencia - Modelo - UDI-DI  
Reference - Model - UDI-DI

I0104NL - LUXIFLEX LED PLUS - 8436562860356  
I0104AOLED - LUXIFLEX LED - 8436562860011  
I0104NLSR - LUXIFLEX SENSOR PLUS - 8436562860417  
I0104AOLEDSR - LUXIFLEX SENSOR - 8436562860400  
I0104AO - LUXIFLEX HAL - 8436562860004

Finalidad prevista  
Intended purpose

Dispositivo para iluminar el lugar de exploración del paciente  
Device intended to provide light to illuminate a site of patient examination

CUMPLE LOS REQUISITOS DEL REGLAMENTO (UE) 2017/745 SOBRE PRODUCTOS SANITARIOS  
COMPLIES WITH THE REQUIREMENTS OF REGULATION (EU) 2017/745 ON MEDICAL DEVICES

Clasificación producto sanitario  
Medical device classification

**CE** CLASE I - REGLA I  
Class I - Rule I

Ensayos y medidas - Normas  
Test and measurements - Standards

UNE-EN 60601-1:2008+/A12:2015 Part 1 Medical equipments  
UNE-EN 60601-1-2:2015 Part 2 Medical equipments  
UNE-EN 60601-2-41:2010+A11:2012+A1:2015

Accesorios  
Accessories

B0101800 - WALL B SUPPORT 09651 - TROLLEY STAND 8,8 kg  
B010190 - AH TABLE CLAMP 09655 - TROLLEY STAND 4 kg  
82026 - RAIL PLUS BRACKET B010150 - EXTENSION ARM

Lugar y fecha  
Location and date

Granollers (Barcelona) España, a 11 de FEBRERO de 2022  
Granollers (Barcelona) Spain, February 11th, 2022

Nombre y cargo  
Name and position



Xavier Codina Jané  
Director General  
General Manager



Oriol Codina Miró  
Responsable Técnico  
Technical Manager

## 15. CERTIFICATE ISO 9001



# MANAGEMENT SYSTEM CERTIFICATE

Certificate no.:  
283445-2019-AQ-IBE-ENAC

Initial certification date:  
20 April 2016

Valid:  
21 April 2022 – 20 April 2025

This is to certify that the management system of

**MIMSAL TRADE, S.L.**

Calla Mollet 17, Pol. Ind Palou Nord, 08401, Granollers, Barcelona, Spain

has been found to conform to the Quality Management System standard:

**ISO 9001:2015**

This certificate is valid for the following scope:

**Manufacturing and distribution of medical devices for the lighting market.**

Place and date:  
**Barcelona, 28 February 2022**

For the issuing office:  
**DNV - Business Assurance**  
Gran Via de les Corts Catalanes 130-136, Pl. 9,  
08038, Barcelona, Spain



**Ana del Rio Salgado**  
Management Representative

Lack of fulfillment of conditions as set out in the Certification Agreement may render this Certificate invalid.

ACCREDITED UNIT: DNV GL Business Assurance España, S.L.U., Gran Via de les Corts Catalanes 130-136, Pl. 9, 08038 Barcelona, Spain - TEL: +34 93 479 26 00.  
[www.dnv.es/assurance](http://www.dnv.es/assurance)

## 16. CERTIFICATE ISO 13485



# MANAGEMENT SYSTEM CERTIFICATE

Certificate no.:  
283446-2019-AQ-IBE-ACCREDIA

Initial certification date:  
27 December 2017

Valid:  
09 February 2022 – 08 February 2025

This is to certify that the management system of  
**MIMSAL TRADE, S.L.**  
 Calla Mollet 17, Pol. Ind Palou Nord, 08401, Granollers, Barcelona, Spain

has been found to conform to the Quality Management System standard:  
**ISO 13485:2016**

This certificate is valid for the following scope:  
**Design, management of production and placing on the market of medical devices (lamps)  
 for the lighting healthcare market.**

Place and date:  
**Vimercate (MB), 02 February 2022**



SGQ N° 003 A  
 SGA N° 003 D  
 SQE N° 007 M  
 SGR N° 004 F

EMAS N° 009 P  
 PRD N° 003 B  
 PRS N° 004 C  
 SSI N° 002 G

Member of MIA EA per gli schemi di accreditamento  
 SQQ, SGA, PRD, PRS, ISR, GHG, LAB, e LAT, di MIA IAF  
 per gli schemi di accreditamento SQQ, SGA, SSI, FSM  
 e PRD e di MIA ILAC per gli schemi di accreditamento  
 LAB, MED, LAT e ISP

For the issuing office:  
**DNV - Business Assurance**  
 Via Energy Park, 14, - 20871 Vimercate (MB) -  
 Italy

**Claudia Baroncini**  
 Management Representative

Link of fulfillment of conditions as set out in the Certification Agreement may render this Certificate invalid.

ACCREDITED UNIT: DNV Business Assurance Italy S.r.l., Via Energy Park, 14 - 20871 Vimercate (MB) - Italy - TEL: +39 68 99 905. www.dnv.it



The logo for MIMSAL, featuring the word "MIMSAL" in a bold, blue, sans-serif font. The letters are closely spaced, and the "M" and "S" have a distinctive, slightly slanted design.

MIMSAL TRADE S.L.

C/ Mollet, 17  
Polígono Industrial Palou Nord  
08401 – Granollers (Barcelona) SPAIN

Tel. +34 930 139 860

mimsal@mimsal.com  
www.mimsal.com

F3P31  
Rev. 01  
20.06.2022