



GIMA

PROFESSIONAL MEDICAL PRODUCTS

GRANDE RIUNITO PARKER PARKER DIAGNOSTIC SET

Manuale d'uso - User manual

- È necessario segnalare qualsiasi incidente grave verificatosi in relazione al dispositivo medico da noi fornito al fabbricante e all'autorità competente dello Stato membro in cui si ha sede.
- All serious accidents concerning the medical device supplied by us must be reported to the manufacturer and competent authority of the member state where your registered office is located.

M31471-M-Rev.1-03.20

REF 31471



Gima S.p.A.
Via Marconi, 1 - 20060 Gessate (MI) Italy
gima@gimaitaly.com - export@gimaitaly.com
www.gimaitaly.com
Made in Pakistan



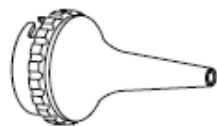
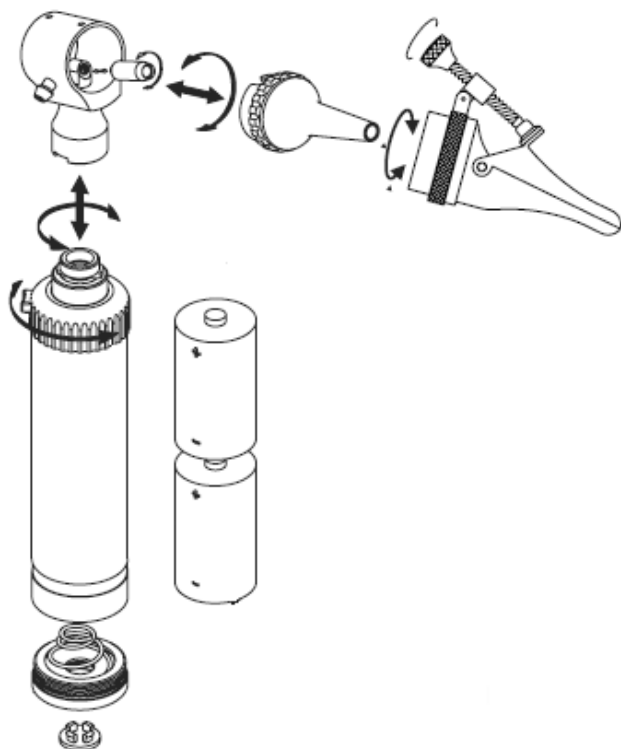

Ø2.5mm

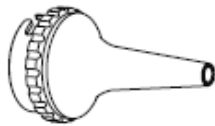

Ø3.5mm

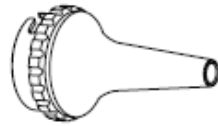

Ø4.5mm

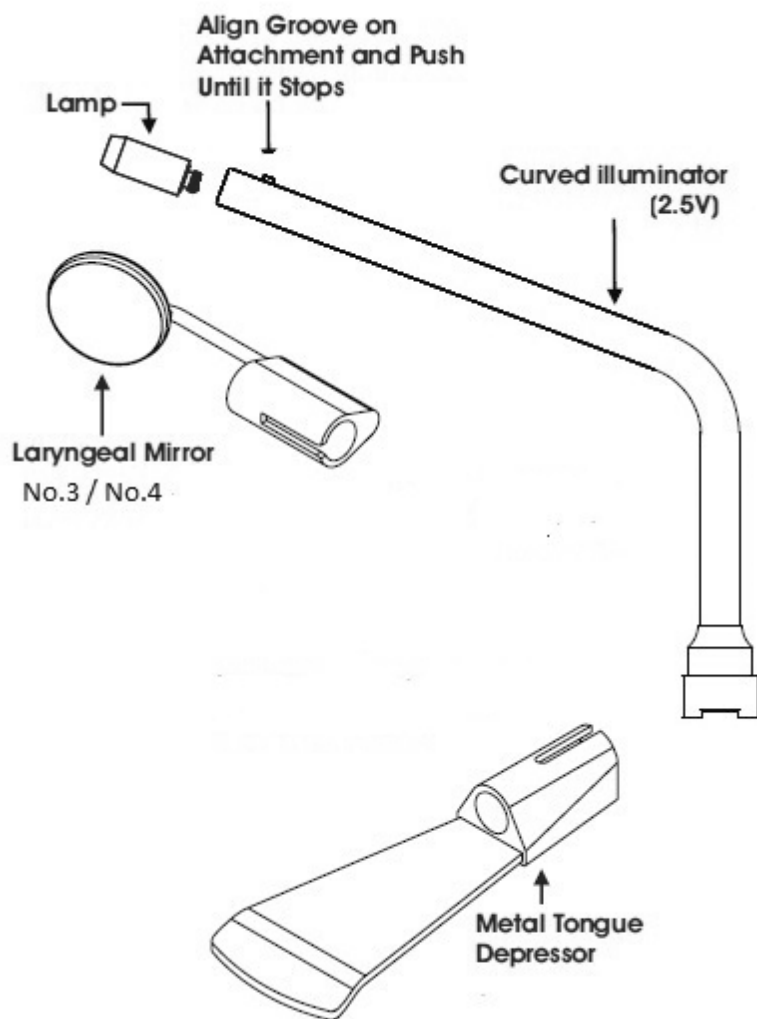

INSTRUCTIONS FOR USE

The operating and maintenance instructions found in this manual should be followed to ensure years of reliable service.

Please read these instructions carefully before using the product and keep them in a safe place for future or use reference.

INTENDED USE AND PRODUCT INFORMATIONS

The Otoscope has universal fittings, which allow a myriad of attachment to be used for Aural and nasal examination. These Otoscopes are extremely helpful in examining the external acoustic duct and the tympanic membrane. This instrument recommended for use by medically qualified personnel. Otoscope is equipped with a rheostat to adjust the intensity of light. The product is equipped with 3 autoclavable ear cannulas Ø 2.5, 3.5 ,4.5 mm.

An adapter can be also supplied to install a disposable alligator speculum (cod. 31494), suitable to examine children.

Note: The product or its components cannot be used for purpose different from the one specified in the present manual. It is not conceived for the employment in operation room.



Due to its powerful luminous intensity, it is advisable not to directly point it at eyes. Do not use the equipment in case it is damaged. Avoid precarious repairs. Repairs shall be carried out with original spare parts only, which shall be installed according to the intended use.

Before using, thoroughly check the product and accessories (if provided) the same operation shall be carried out after cleaning.

This product is equipped with an easy to use Bayonet Locking System. This product is powered by two 1.5 V "C" type alkaline batteries.

INSTALLATION

- Before using it, it is necessary to insert the batteries into the Handle compartment.

Proceed as follows:

- Open the battery compartment. To do this, turn the end cap counter clockwise.

- Once opened, insert the batteries paying attention to the direction of poles (see picture).

- To close the battery compartment, screw down the cap clockwise and check that the batteries are in contact with poles.

For Operating otoscope / ophthalmoscope with bayonet locking system proceed as follows:

- It is necessary to hold the handle and head in each hand and turn the head counter-clockwise until a click is heard. At this point it is possible to take the head off.

- To re-attach the head, match the bayonet grooves on both the head and handle, push the head down and turn the head clockwise.

The operation necessary to remove and replace the speculum is very simple:

- Turn the speculum counter clockwise and draw it out of its seat.

- To re-attach the speculum, insert it into the speculum mount by matching the grooves with the small pivot and turn clockwise.

CURVED ILLUMINATOR

Various attachments such as mirrors and tongue depressors can be attached to the curved illuminator.

HANDLES

Battery handles contain Rheostats. To turn the power on / off, depress the white button and rotate the Rheostat.



• Do not allow liquid to seep into the Handle heads, Ophthalmoscope, Otoscope heads and the Laryngeal stems.

• Reusable speculums, Mirrors and Tongue Depressors can be washed with soapy water and thoroughly dried.

• Allow bulbs to cool down before replacing.

BATTERIES (OPTIONAL)

The Battery handles accept 2 x "C" batteries. We recommend "Alkaline" batteries for all our Diagnostic systems for Optimum performance. Only use genuine accessories and bulbs. Alternatives may shorten the life of your purchase

STORAGE

Since the product is made of corrosion-proof materials suitable for environmental conditions foreseen for its normal use, it does not require special care. However it is necessary to store it in a closed place making sure that is protected from dust and dirt to assure it's hygienic properties. Store in clean environment and preserve in normal temperature.

MAINTENANCE

If the light is intermittent or in case it does not turn on, check the bulb, the batteries and the electric contacts. In case the lamp stops working, it is possible to replace it with original spare lamp to replace the lamp, follow lamp replacement instructions see Fig.

Periodically check the battery condition, making sure that no sign of corrosion or oxidation is present, in case they have to be replaced, it is highly recommended to use new Alkaline ones. Carefully handle the batteries as the liquids they contain can irritate skin and eyes.













Before using, thoroughly check the product and accessories. The same operation shall be carried out after cleaning. Check that the connection between the head and the handle is perfect and that the rheostat works correctly. If the light is intermittent or in case it does not turn on, check the bulb, the batteries and the electric contacts.

In case the bulb stops working, it is possible to replace it with original spare lamp. To replace the bulb, Simply turn the bulb counter-clockwise(see picture). It is advisable to use only original bulbs, with correct voltage (2.5/3.5V) with regard to your handle.

Before removing the bulb, make sure that the instrument has been turned off for some minutes, otherwise you run the risk of being burnt.

It is advisable to always have new bulbs and batteries at disposal for the maximum light. however they cannot be dipped into liquids.

The speculum can be sterilized in boiling water or in an autoclave (in this case the temperature shall not be over 121°C). Alternatively, cold disinfectants can be used with the same concentration used to sterilize medical instruments.

Symbols					
	Caution: read instructions (warnings) carefully		Medical Device compliant with Regulation (EU) 2017/745		Product code
	Manufacturer		Date of manufacture		Lot number
	Keep away from sunlight		Keep in a cool, dry place		WEEE disposal
	Type B applied part		Follow instructions for use		Medical Device



Disposal: The product must not be disposed of along with other domestic waste. The users must dispose of this equipment by bringing it to a specific recycling point for electric and electronic equipment.

GIMA WARRANTY TERMS

The Gima 12-month standard B2B warranty applies.

