

BM5VET User Manual

Patient Monitor
Rev. 2.0



Table of Contents

<i>BM5VET User Manual</i>	0
Table of Contents	1
1. BASIC	5
1.1 CE Standard Information	6
1.2 Read before Use	7
How to Contact Us	7
Warranty Period.....	8
Warning, Caution, Note.....	9
General Precaution on Environment.....	10
General Precaution on Electric Safety	15
Cleaning Applied Parts.....	17
1.3 Product Components	19
Overview of the Product.....	19
Features of the Product	19
Product Configuration	20
Optional Products	20
1.4 Function and Key	26
External Function	26
Operation Key	26
1.5 Standard Power Supply Application	28
DC Power	28
1.6 Battery Power Supply Application	29
Operation	29
The Impact of Lithium-Ion Battery Technology on the Battery	30
Conditioning Guideline	31
Storage Guideline	31
How to Recycle the Battery.....	31
1.7 General Manu Operation	32
Screen Composition.....	32
Menu Selection	33
Menu Composition	33
2. PATIENT/DATA MANAGEMENT	37
2.1 ADMIT	38
ANIMAL TYPE	38
CHANGE ANIMAL INFORMATION.....	39
DEFAULTS SETTING	39
HEIGHT	40
WEIGHT	40
2.2 ALARM	41
Alarm for the Product.....	42
ALL LIMITS	43
ALARM PRINT	43
ALARM VOLUME.....	44

ALARM LEVEL	44
PARAMETER LEVEL	45
ARRHYTHM LEVEL	45
ALARM REVIEW	46
SAVE CONDITION	48
NURSE CALL	49
3. SETUP	50
3.1 SETUP	51
DISPLAY	51
SET PARA	52
WAVE SELECT	52
SET DATE & TIME	55
SET TIME	56
SET DATE	56
HR SOURCE	57
SWEEP SPEED	57
DEMO	58
USER SERVICE	58
SET UNIT NAME	58
SET BED NUMBER	59
AC FILTER	59
SYSTEM	60
MAKER SERVICE	60
4. TREND	61
4.1 TREND	62
GRAPHIC TREND	63
TIME PERIOD	64
TIME INTERVAL	66
TREND WINDOW SETUP	66
TIME PERIOD	67
SET TREND PARA	67
TREND PRINT	68
5. ECG	69
5.1 Introduction	70
Colors and Standards of Cables	70
Position of ECG Connector and Measuring Cable	70
Attaching Electrodes to the Animal	71
Choosing an ECG lead for Arrhythmia Monitoring	72
Information on the ECG waveform	72
Position of 3-Lead Wire Electrode	73
Position of 5-Lead Wire Electrode	74
5.2 ECG Data Window	75
5.3 ECG Data Setup	78
ALARM LIMIT	82
ALARM SOUND	83
QRS VOLUME	83
DISPLAY	84
ECG SWEEP SPEED	84
ECG SIZE	85
HR SOURCE	85

7CHANNEL VIEW	86
ANALYSIS SETTING.....	87
6. SpO₂	101
6.1 Outline	102
6.2 SpO₂ Data Window	104
Signal and Data Validity.....	105
6.3 SpO₂ Data Setup	107
RATE VOLUME.....	107
ALARM.....	108
ALARM LIMIT.....	108
ALARM SOUND.....	109
LEAD FAULT Condition.....	109
SPO ₂ Messages	110
7. RESPIRATION	111
7.1 Outline	112
7.2 Respiration Data Window	113
7.3 Respiration Data Setup	114
RESPIRATION SPEED	114
RESPIRATION	115
APNEA DETECT	115
LEAD SELECT	115
ALARM.....	116
ALARM LIMIT.....	116
ALARM SOUND.....	117
8. NIBP	119
8.1 Outline	120
8.2 NIBP Data Window	123
8.3 NIBP Data Setup	124
ALARM.....	124
ALARM LIMIT.....	124
ALARM SOUND	125
CUFF SIZE.....	126
UNIT SELECT.....	126
INTERVAL	127
9. IBP.....	129
9.1 Description	130
9.2 IBP Data Window	133
9.3 IBP Data Setting	134
10. EtCO₂.....	143
10.1 Introduction	144
10.2 EtCO₂ Parameter Window.....	150
10.3 EtCO₂ Parameter Setting Menu	151

EtCO2 SWEEP SPEED	152
11. TEMPERATURE.....	157
11.1 Outline	158
11.2 Temperature Data Window.....	159
11.3 Temperature Data Setup	160
ALARM.....	160
ALARM LIMIT.....	161
UNIT SELECT	162
12. PRINT.....	163
12.1 Print	164
Printer and Heat Sensitivity Paper.....	164
Function and Setup Menu.....	165
12.2 Paper Change.....	167
13. MESSAGE LIST	168
14. FACTORY DEFAULTS.....	169
Alarm level (Horse).....	170
Alarm level (Dog).....	171
Alarm level (Cat and Puppy).....	172
Parameter Limits(Horse)	173
Parameter Limits(Dog).....	174
Parameter Limits(Cat and Puppy)	175
15. TROUBLE SHOOTING	176
15.1 Noise in ECG.....	176
15.2 SpO2 malfunction.....	177
15.3 Temp malfunction	177
15.4 NIBP malfunction.....	178
15.5 Abnormality in NIBP measurements.....	178
15.6 Failure in battery recharge.....	179
15.7 Power failure.....	180
15.8 Periodic noises.....	181
15.9 Print failure.....	182
16. SPECIFICATION.....	183
Ease of use.....	184
Additional Function.....	184
Monitor Environmental Specifications.....	184
Power.....	184
Specification.....	Errore. Il segnalibro non è definito.
Accessories Included:.....	187
Option.....	187
Abbreviations and Symbols.....	188
PRODUCT WARRANTY	191

1. BASIC

1.1 CE Standard Information

1.2 Read before Use

Warranty Period

Warning, Caution, Note

General Precaution on Environment

General Precaution on Electric Safety

Equipment Connection, Maintenance & Washing Equipment Connection

1.3 Product Components

Product Outline

Principal Characteristics of Product

Product Configuration and Option Product

Product Body Configuration

1.4 Function and Key

External Function

Operation Key

1.5 Standard Power Supply Application

1.6 Battery Power Supply Application

1.7 General Menu Operation

Screen Composition

Menu Selection

Menu Composition

1.1 CE Standard Information

Electromechanical safety standards met:

- EN 60601-1: 1990 + A1:1993 + A2: 1995 + A13:1996 Medical Electrical Equipment, Part 1, General Requirements for Safety.
- IEC/EN 60601-1-2:2001 Electromagnetic compatibility -Requirements and tests.
- EN 1060-1:1995 Non-invasive sphygmomanometers - Part 1: General requirements
- EN 1060-3:1997 Non-invasive sphygmomanometers - Part 3: Supplementary requirements for electro-mechanical blood pressure measuring systems
- EN ISO 9919:2005 Medical electrical equipment - Particular requirements for the basic safety and essential performance of pulse oximeter equipment for medical use (ISO 9919:2005)
- EN 60601-2-27:2006 Medical electrical equipment - Part 2-27: Particular requirements for the safety, including essential performance of electrocardiographic monitoring equipment
- EN 60601-2-30:2000 Medical electrical equipment - Part 2-30: Particular requirements for the safety, including essential performance of automatic cycling non-invasive blood pressure monitoring equipment
- EN 12470-4:2001 Clinical thermometers - Part 4: Performance of electrical thermometers for continuous measurement
- EN 60601-2-49:2001 Medical electrical equipment - Part 2-49: Particular requirements for the safety of multifunction patient monitoring equipment
- EN/IEC60601-2-34:2000 Medical electrical equipment-Part 2: Particular requirements for the safety, including essential performance, of invasive blood pressure monitoring equipment
- EN/ISO 21647:2004 Medical electrical equipment – Particular requirements for the basic safety and essential performance of respiratory gas monitors

1.2 Read before Use

GIMA services are always available to you.

The followings are address and phone number for contacting information, services, and product supplies.

How to Contact Us

- In the event of malfunction or failure, contact us along with the model name, serial number, and product name of the equipment.
- If you need the supply circuit diagram, component list, description and calibration instruction etc. you can contact us we will provide you with it.

Warranty Period

This product is manufactured and passed through strict quality control and through inspection.

Compensation standard concerning repair, replacement, refund of the product complies with "Consumer's protection law" noticed by Economic Planning Dept.

We provide a 1-year warranty period.(Two years in Europe)

We will repair or replace any part of the BM5VET found to be defective in usual operating circumstance for free to you.

This warranty does not apply to any defect caused by improper abuse, misuse or exposure to poor management.

Warning, Caution, Note

For special emphasis on agreement, terms are defined as listed below in user manual. Users should operate the equipment according to all the warnings and cautions.





Warning
To inform that it may cause serious injury or death to the patient, property damage, material losses against the “warning” sign

Caution
To inform that it may cause no harm in life but lead to injury against the “caution” sign

Note
To inform that it is not dangerous but important “note” sign for proper installation, operation, and maintenance of the equipment.

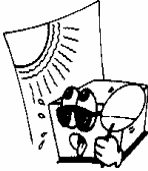
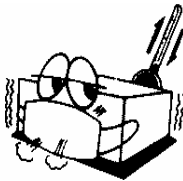
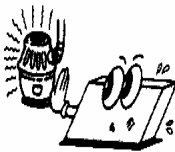
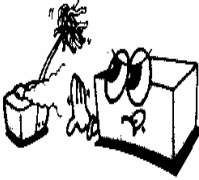
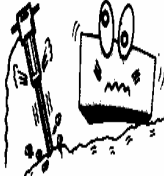
General Precaution on Environment

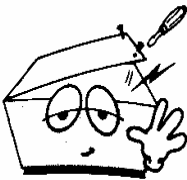
- Do not keep or operate the equipment in the environment listed below.

	<p>Avoid placing in an area exposed to moist. Do not touch the equipment with wet hand.</p>		<p>Avoid exposure to direct sunlight</p>
	<p>Avoid placing in an area where there is a high variation of temperature. Operating temperature ranges from 10(C to 40(C. Operating humidity ranges from 30% to 85%.</p>		<p>Avoid in the vicinity of Electric heater</p>
	<p>Avoid placing in an area where there is an excessive humidity rise or ventilation problem.</p>		<p>Avoid placing in an area where there is an excessive shock or vibration.</p>
	<p>Avoid placing in an area where chemicals are stored or where there is danger of gas leakage.</p>		<p>Avoid being inserted dust and especially metal material into the equipment</p>
	<p>Do not disjoint or disassemble the equipment. We take no responsibility for it.</p>		<p>Power off when the equipment is not fully installed. Otherwise, equipment could be damaged.</p>

CAUTIONS

Before Installation

Compatibility is critical to safe and effective use of this device. Please contact your local sales or service representative prior to installation to verify equipment compatibility.

Defibrillator Precaution

Patient signal inputs labeled with the CF and BF symbols with paddles are protected against damage resulting from defibrillation voltages. To ensure proper defibrillator protection, use only the recommended cables and lead wires.

Proper placement of defibrillator paddles in relation to the electrodes is required to ensure successful defibrillation.

Disposables

Disposable devices are intended for single use only. They should not be reused as performance could degrade or contamination could occur.

Disposal of your old appliance

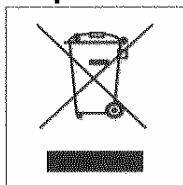

1. When this crossed out wheeled bin symbol is attached to a product it means the product is covered by the European Directive 2002/96/EC.
2. All electrical and electronic products should be disposed of separately from the municipal waste stream via designated collection facilities appointed by the government or the local authorities.
3. The correct disposal of your old appliance will help prevent potential negative consequences for the environment and human health.
4. For more detailed information about disposal of your old appliance, please contact your city office, waste disposal service or the shop where you purchased the product.

Electrocute Precautions

To prevent skin burns, apply electrocute electrodes as far as possible from all other electrodes, a distance of at 15 cm/6 in. is recommended.

EMC

Magnetic and electrical fields are capable of interfering with the proper performance of the device.

For this reason make sure that all external devices operated in the vicinity of the monitor comply with the relevant EMC requirements. X-ray equipment or MRI devices are possible source of interference as they may emit higher levels of electromagnetic radiation.

Also, keep cellular phones to other telecommunication equipment away from the monitor.

CAUTIONS

Instruction for Use

For continued safe use of this equipment, it is necessary that the instructions are followed. However, instructions listed in this in no way supersede established medical practices concerning patient care.

Loss of Data

Should the monitor at any time temporarily lose patient data, the potential exists that active monitoring is not being done. Close patient observation or alternate monitoring devices should be used until monitor function is restored.

If the monitor does not automatically resume operation within 60 seconds, power cycle the monitor using the power on/off switch. Once monitoring is restored, you should verify correct monitoring state and alarm function.

Maintenance

Regular preventive maintenance should be carried out annually (Technical inspections). You are responsible for any requirements specific to your country.

MPSO

The use of a multiple portable socket outlet (MPSO) for a system will result in an enclosure leakage current equal to the sum of all individual earth leakage currents of the system if there is an interruption of the MPSO protective earth conductor. Do not use an additional extension cable with the MPSO as it will increase the chance of the single protective earth conductor interruption.

Negligence

GIMA does not assume responsibility for damage to the equipment caused by improperly vented cabinets, improper or faulty power, or insufficient wall strength to support equipment mounted on such walls.

NOTES

Power Requirements

Before connecting the device to the power line, check that the voltage and frequency. Ratings of the power line are the same as those indicated on the unit's label. If this is not the case, do not connect the system to the power line until you adjust the unit to match the power source. In U.S.A, if the installation of this equipment will use 240V rather than 120V, the source must be a center-tapped, 240V, single-phase circuit.

Restricted Sale

U.S.A federal law restricts this device to sale by or on the order of a physician.

Supervised Use

This equipment is intended for use under the direct supervision of a licensed health care practitioner.

Ventilation Requirements

Set up the device in a location which affords sufficient ventilation. The ventilation openings of the device must not be obstructed. The ambient conditions specified in the technical specifications must be ensured at all times.

·Put the monitor in a location where you can easily see the screen and access the operating controls.

·This product is protected against the effects of cardiac defibrillator discharges to ensure proper recovery, as required by test standards. (the screen may blank during a defibrillator discharge but recovers within second as required by test standards.)

Reference Literature

Medical Device Directive 93/42/EEC

EN 60601-1/1990 +A1: 1993 +A2 : 1995 : Medical electrical equipment.

General requirements for safety

EN 60601-1-1/9. 1994 +A1 12.95: General requirements for safety.

General Precaution on Electric Safety

Warning

Check the item listed below before operating the equipment.

1. Be sure that AC power supply line is appropriate to use. (AC100 - 240V)
2. Be sure that the power source is the one supplied from GIMA. (DC18V, 2.5A)
3. Be sure that the entire connection cable of the system is properly and firmly fixed.
4. Be sure that the equipment is completely grounded. (If not, there might be the problem occur in the product.)
5. The equipment should not be placed in the vicinity of electric generator, X-ray, broadcasting apparatus to eliminate the electric noise during operation. Otherwise, it may cause incorrect result.

Note

The Equipment should be placed far from generator, X-ray equipment, broadcasting equipment or transmitting wires, so as to prevent the electrical noises from being generated during the operation, When these devices are near the Equipment, it can produce inaccurate measurements. For BM5VET, both independent circuit and stable grounding are essentially required. In the event that the same power source is shared with other electronic equipment, it can also produce inaccurate output.

Warning

Do not contacts with the patient while operate the machine It may cause serious danger to the users. Use only the provided cable.

Warning

In case the Equipment does not operate as usual or damaged, do not use on patient, and contact to the medical equipment technician of the hospital or the equipment supply division.

Note

BM5VET is classified as follows:

- BM5VET classifies as Class I, BF & CF concerning electric shock. It is not proper to operate this Equipment around combustible anesthetic or dissolvent.
- Noise level is B class regarding IEC/EN 60601-1 and the subject of Noise is B level concerning IEC/EN60601-1-2.

Equipment Connection

Caution

In the hospital, doctors and patients are exposed to dangerous, uncontrollable compensating currents. These currents are due to the potential differences between connected equipment. The safety solution to the problem is accomplished with EN60601-1;1996.

Biocompatibility

When used as intended, the parts of the product described in this operator manual, including accessories that come in contact with the patient during the intended use, fulfill the biocompatibility requirements of the applicable standards. If you have questions about this matter, please contact GIMA or its representatives.

Maintenance and Washing Equipment Connection

Using various methods can clean BM5VET and its accessories. Please follow the methods mentioned below to avoid unnecessary damage or contamination to the Equipment.

We do not repair with free of charge regardless of warranty period if it is contaminated or damaged with using dangerous material not designated for washing.

Cleaning Applied Parts

Cables and Leadwires

CAUTION

Do not use acetone or ketone solvents for cleaning; do not use an autoclave or steam cleaner.

Cables and leadwires can be cleaned with a warm, damp cloth and mild soap, or isopropyl alcohol wipes. For more intensive disinfecting (near sterile) Ethylene Oxide (ETO) is acceptable but will reduce the useful lifetime of the cable or leadwire.

CAUTION

The decision to sterilize must be made per your institution's requirements with an awareness of the effect on the integrity of the cable or leadwire.

Note

The Equipment needs safety inspection once a year. Please refer to user's guide or service manual for the examine objects.

Please check carefully both frame and sensor, after cleaning the Equipment, Do not use the equipment that is worn out or damaged.

At least once a month, clean and wipe off the frame by using the soft cloth after wetting it with water and alcohol. Do not use lacquer, thinner, ethylene, and oxidizer which may leads damage to the equipment.

Make sure both cables and accessories are free of dust or contaminants, and wipe them off with soft cloth wetted with warm water (40°), and at least once a week, clean them by using the clinical alcohol.

Do not submerge the accessories under any liquid or detergent. Also, make sure any liquid not to

penetrate into the Equipment or probe.

Caution

Do not dispose single use probe to any hazard place, Always think about environmental contamination.

Caution

There is back-up battery on board inside system. When users dispose this battery, Please waste proper place for environmental protection.

Warning

Check the electrodes of batteries before changing them.

- Operate BM5VET with internal electric power supply when unsure of external ground connection or installation occur.
- Remove the 1st Battery when not using equipment for a while without any damage.

For other applied parts such as temperature sensors, pulse oximetry probes, and NBP cuffs, you must consult the manufacturer for cleaning, sterilization, or disinfecting methods.

1.3 Product Components

Overview of the Product

BM5VET monitor is a product used for monitoring biological information of cat, puppy, dog and horse. Main functions of the product include displaying information such as ECG, respiration, SpO₂, NIBP and temperature on its LCD screen and monitoring parameter, and alarming. It also prints out waves and parameters via a printer.

Features of the Product

BM5VET is the small-size multi-functional monitoring equipment for an animal, especially designed to use easily during movement. It features DC power input for vehicle and installing this equipment on the handle of the bed. And, In case of using capnography station which is provided optionally, the direct AC(100~240V, 50/60Hz) input is available. The equipment also measures major parameters such as ECG, SpO₂, NIBP, IBP, EtCO₂, temperature, respiration and pulse, displaying it on a 10.4-inch color LCD screen. It also enables users to check waves and parameters and other vital signs of a patient via the 58mm thermal printer and monitor the patient by the remote-controlled alarm system. It also enables to build a central monitoring system by linking devices used for separate patients so that one can monitor several patients at a time.

Warning
You may have distortion or signal noise when you use nonstandard or other brand's accessories. We strongly recommend you use only the authorized accessories which we supply.

Warning
BEFORE USE — Before putting the system into operation visually inspect all connecting cables for signs of damage. Damaged cables and connectors must be replaced immediately. Before using the system, the operator must verify that it is in correct working order and operating condition. Periodically, and whenever the integrity of the product is in doubt, test all functions.

Product Configuration

1. Main body of BM5VET Monitor	1 EA
2. 3-Lead Patient Cable (3CBL-400, 3WIRE-430)	1 EA
3. NIBP extension tube (NBPCBL-400)	1 EA
4. Reusable NIBP cuff (25-35 cm, ACUFF-430)	1 EA
5. SpO ₂ sensor extension cable (SPCBL-400)	1 EA
6. Reusable SpO ₂ sensor (SPASENS-400)	1 EA
7. DC Power Adaptor with Power Cord (18VDC/2.5A, KA1803F52)	1 EA
8. Operator`s Manual	1 EA
9. Chart Paper (PAPER-400)	2Roll

Optional Products

1. Reusable Temperature Probe (Surface/Skin, TEMPESENS-430)	1EA
2. IBP Transducer Set (Disposable/Reusable)	1SET
3. Capnography Station (Microstream EtCO ₂ , Oridion)	1SET
4. Sidestream EtCO ₂ Module (Respironics)	1SET
5. Mainstream EtCO ₂ Module (Respironics)	1SET
6. Microstream EtCO ₂ airway adapter aampling kit	1EA
7. Sidestream EtCO ₂ airway adapter sampling kit	1EA
8. Mainstream EtCO ₂ airway adapter	1EA

Warning

In order to avoid electrical shock, do not open the cover. Disassembling of the equipment should be done only by the service personnel authorized by GIMA

Warning

Users must pay attention on connection any auxiliary device via LAN port or nurse calling. Always consider about summation of leakage current, please check if the auxiliary device is qualified by IEC 60601-1, or consult your hospital biomedical engineer.

Features of Main Body

FRONT

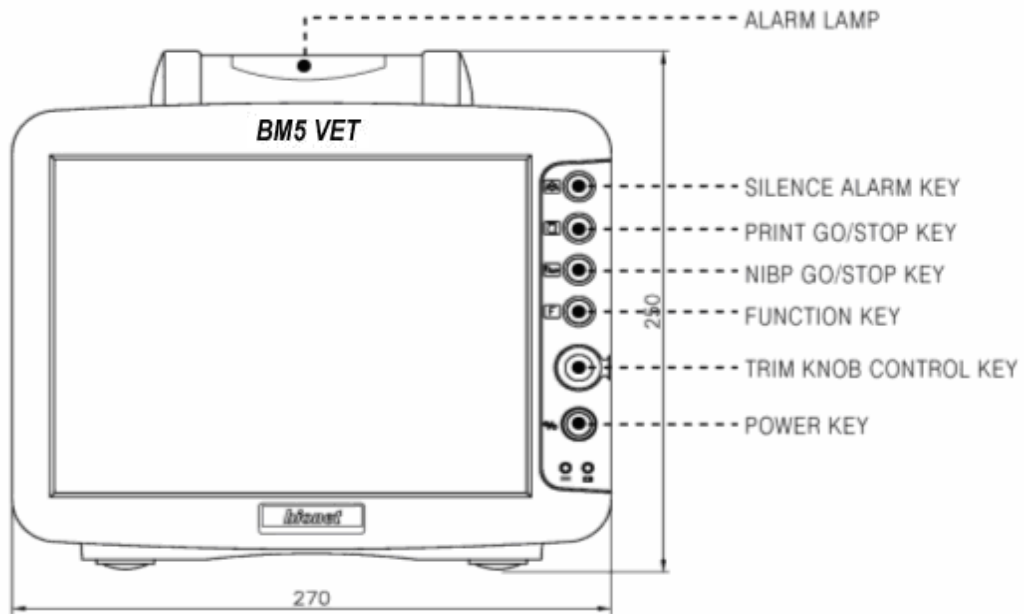

BACK

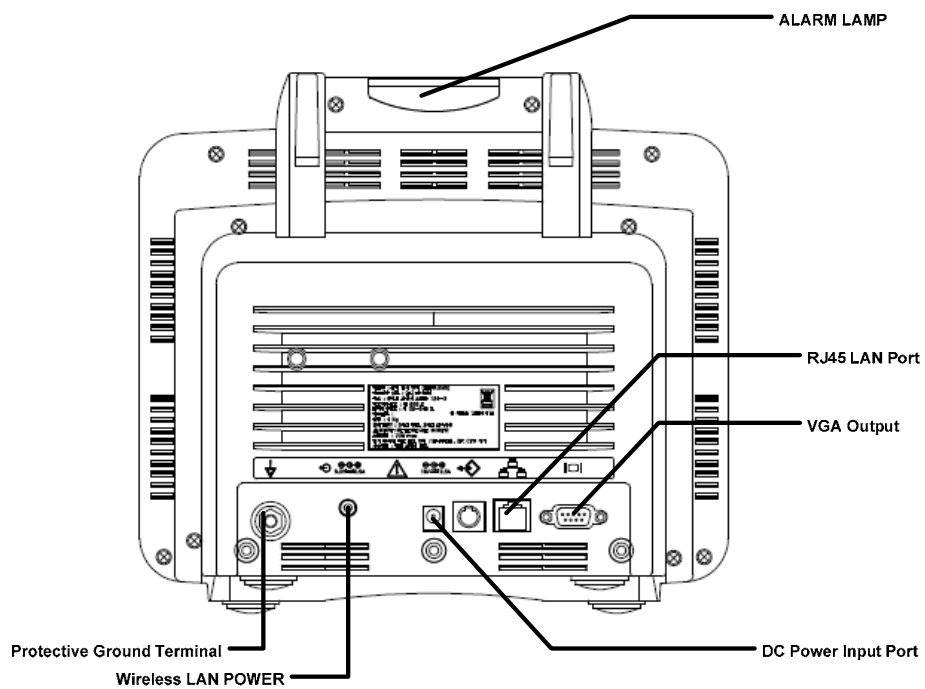

● Right Side

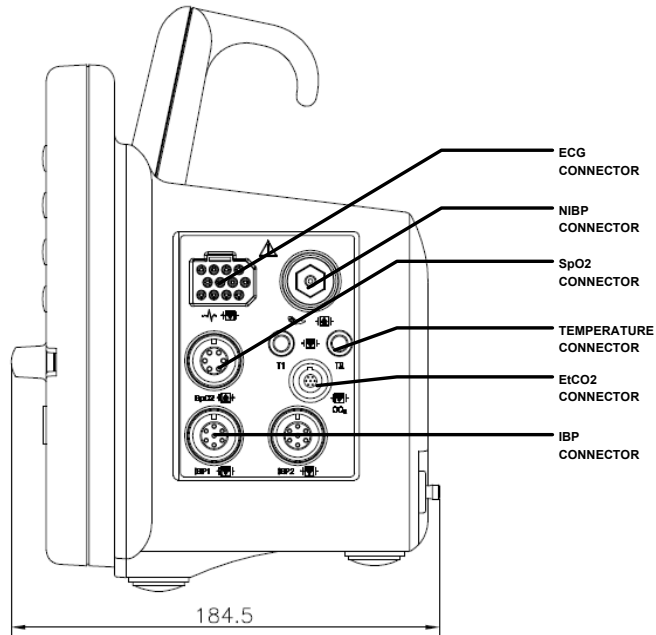

● Left Side

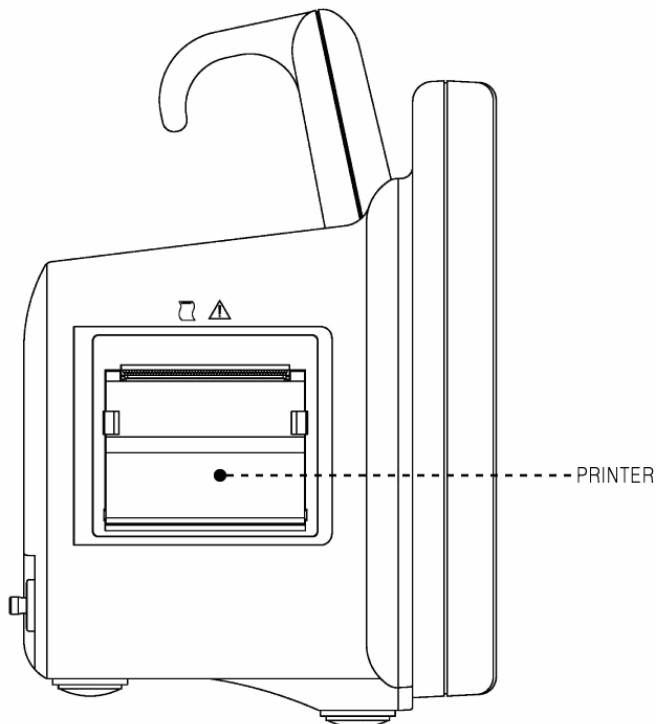

Accessories

ECG Cable
Extension Cable



SpO2 Cable +
Extension Cable

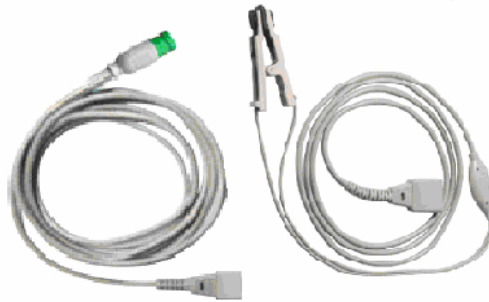





NIBP Cable
Extension Cable







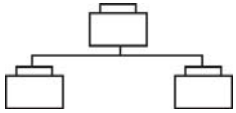
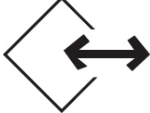

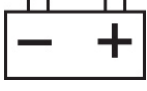
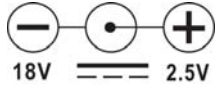

TEMP(OPTION)



Equipment Symbols

	<p>External Ground</p>
	<p>PRINTER</p>
	<p>RS-232, Serial port</p>
	<p>LAN port</p>
	<p>AUX CONNECTOR</p>
	<p>DC INPUT INDICATOR</p>
	<p>BATTERY OPERATION INDICATOR</p>
	<p>DC INPUT CONNECTOR</p>

	NIBP
T	Temperature
F	Function
	Power on
	Power off
	Respiration
	ECG
	Heart Pulse
	EtCO2 Input Display
	EtCO2 Output Display

1.4 Function and Key

External Function

The front panel of this product consists of an LCD screen and five function keys and one trim knob.

Operating the BM5 Patient Monitor

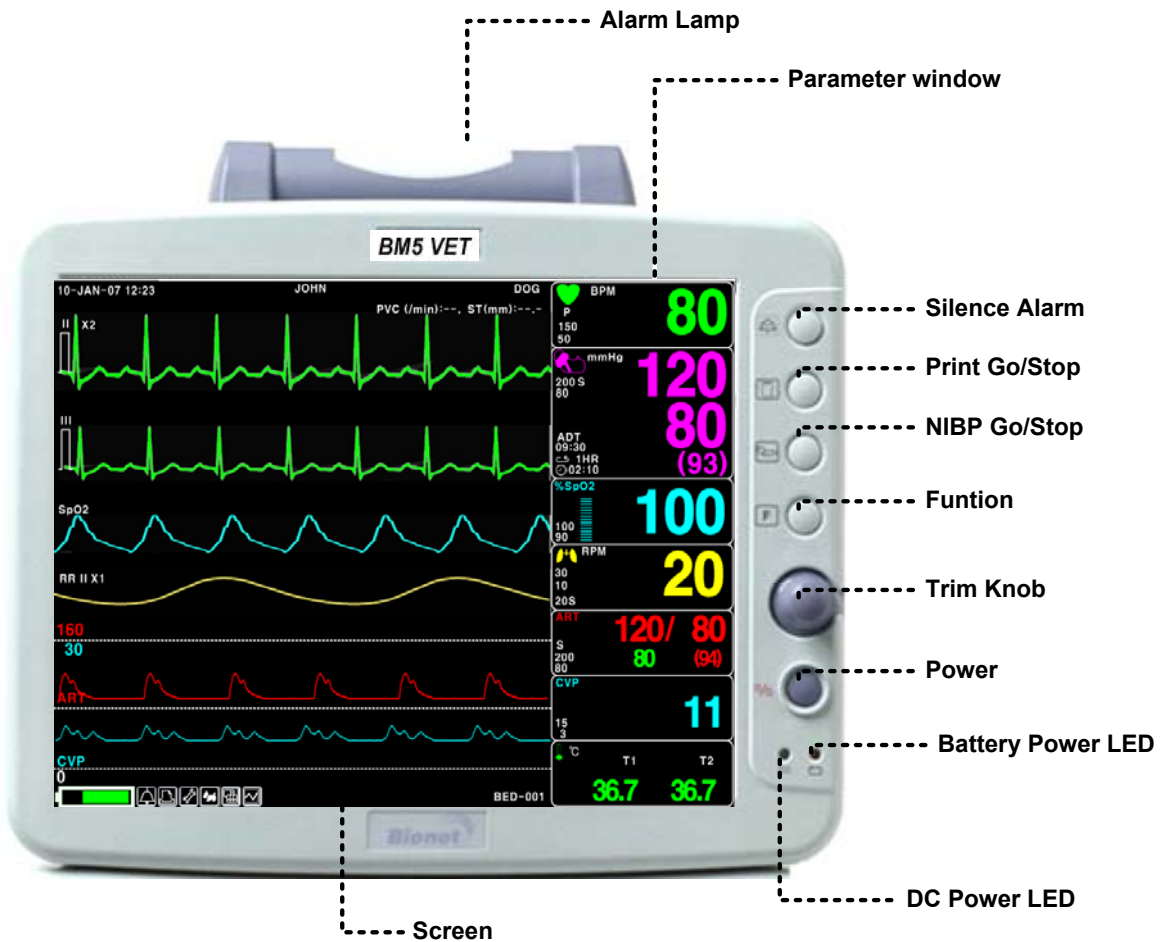

Operation Key

1. Silence Alarm : When this key is pressed once, alarm sound is muted for 1 minute. And When this key is pressed twice, alarm sound is muted for 5 minutes.
2. Print Go/Stop : When this key is pressed, the displaying waveform, parameter, and patient informations start to be printed out via printer. And if pressed again, the printing operation is stopped.
3. NIBP Go/Stop : This key is used for starting and stopping NIBP operation. When this key is

pressed, the NIBP measurement is started. And if this key is pressed again during the measurement, the NIBP measurement is stopped,

4. Function : This key is used to change the display mode.
5. Trim Knob : This key is used to move menu by turning it clockwise or anticlockwise and select menu by pressing it.
6. Power : This key is used to turn on and off this device.

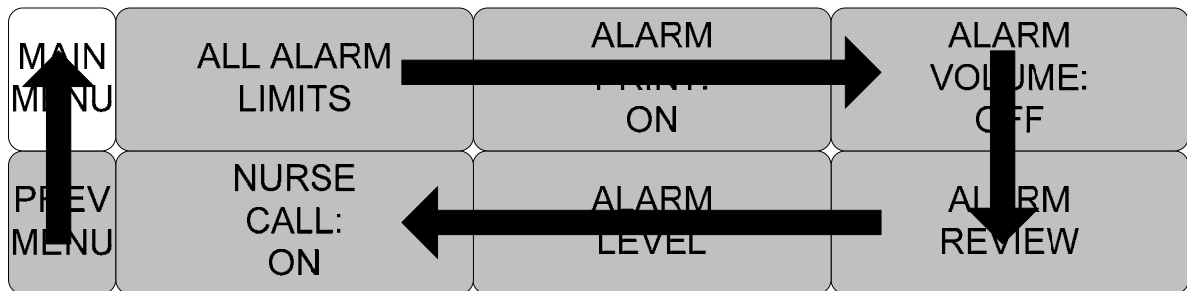
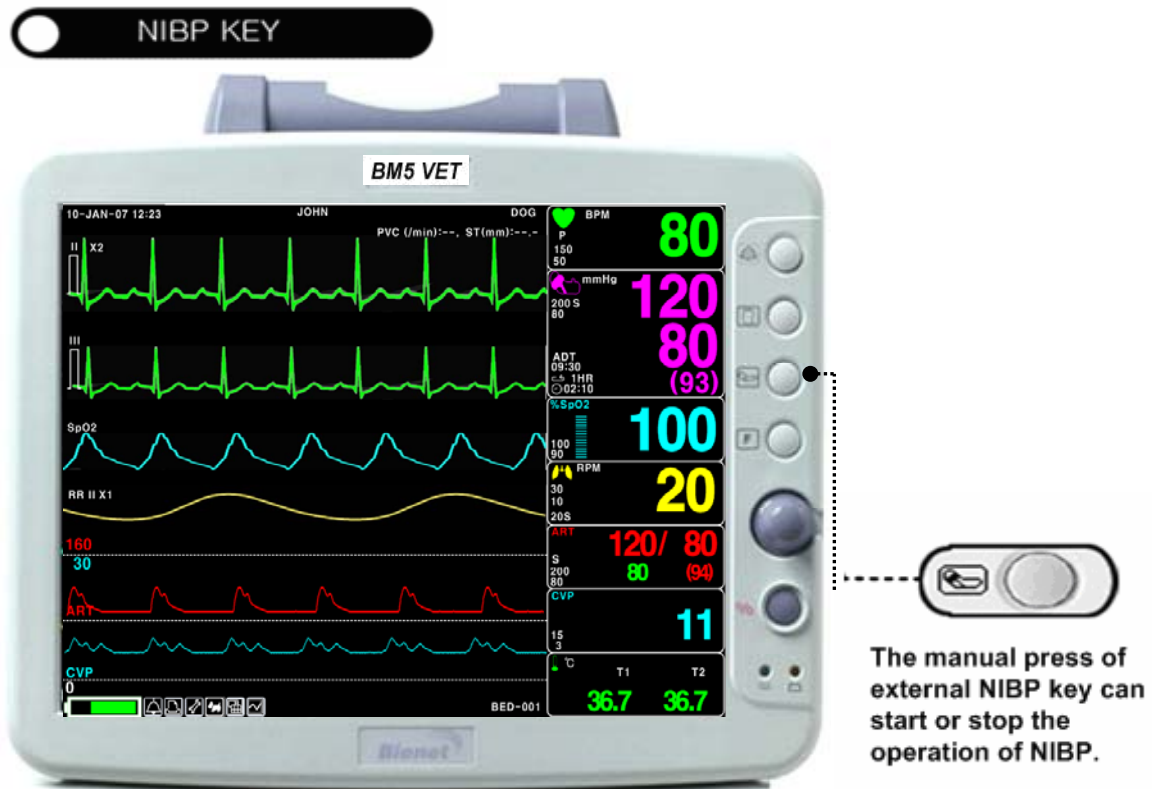

1.5 Standard Power Supply Application

DC Power

DC Power LED is lighted on when the DC Power is plugged into the inlet at the back of the product. A press of power key makes the machine ready for use.

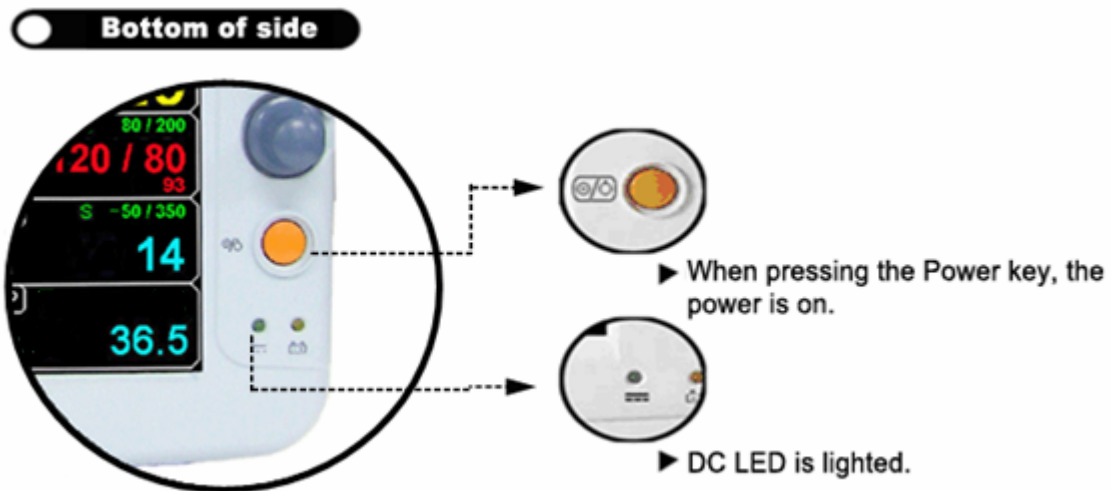

Warning

This equipment must only be connected to a supply mains with protected earth.

1.6 Battery Power Supply Application

Battery power can be supplied for enabling a portable use or a use during DC power failure.

Operation

1. Battery Power LED is lighted on when the machine is in use.
2. The DC/battery power is only sustainable for 1 hour.
3. Battery is automatically charged when the machine is connected to DC Power Supply. Battery LED is lighted on after blinking.
4. The charging status of the batteries is displayed with 5 green boxes, each indicating a different charging
 . (0% -> 25% -> 50% -> 75% -> 100%)



- Battery: LS1865L2203S1PMXZ(11.1V - 2200mA, Li-ion)

The Lithium-Ion battery is a rechargeable battery containing Lithium-Ion cells. Each battery contains an integrated electronic fuel gauge and a safety protection circuit.



5. The discharge condition of battery is indicated with on of 5 yellow boxes, each box showing a different level of charge available.

. (100% -> 75% -> 50% -> 25% -> 0%)



When remained battery is less than 25%, the battery icon box is turned to red one with blink. The device will be turned off automatically after 5 minutes from that warning sign. In case of that warning sign with red and blink at icon box, charge the device immediately with DC power adaptor which is provided from GIMA.



-Battery charging time: More than 6 hours

-Continuous battery use time: Lowest 1 hour to highest 2 hours continuous use (buffering)

Warning

Check the electrodes of batteries before charging them.

6. Battery status indication: When battery is apart from equipment and out of order, it is shown by a red 'X' as shown below.

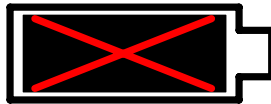

7. Automobile power supply: When an automobile power uses 12V~15V, the battery indication disappears and the "CAR" indication is active.



Display of automobile power

Note

Battery is not charged when the automobile power is used.

The Impact of Lithium-Ion Battery Technology on the Battery

The following are the key points you should know about Lithium-Ion battery technology:

The battery will discharge on its own, even when it is not installed in a monitor. This discharge is the

result of the Lithium-Ion cells and the bias current required for the integrated electronics.

By the nature of Lithium-Ion cells, the battery will self-discharge.

The self-discharge rate doubles for every 10°C (18°F) rise in temperature.

The capacity loss of the battery degrades significantly at higher temperatures.

As the battery ages, the full-charge capacity of the battery will degrade and be permanently lost. As a result, the amount of charge that is stored and available for use is reduced.

Conditioning Guideline

the battery in the monitor full charged and discharged every six months and condition it using the battery charger.

Storage Guideline

Store the battery outside of the monitor at a temperature between 20°C to 25°C (68°F to 77°F).

When the battery is stored inside a monitor that is powered by an AC power source, the battery cell temperature increases by 15°C to 20°C (59°F to 68°F) above the room's ambient temperature. This reduces the life of the battery.

When the battery is stored inside a monitor that is continuously powered by an AC power source and is not powered by battery on a regular basis, the life of the battery may be less than 12 months. GIMA recommends that you remove the battery and store it near the monitor until it is needed for transport.

How to Recycle the Battery

When the battery no longer holds a charge, it should be replaced. The battery is recyclables.

Remove the old battery from the monitor and follow your local recycling guidelines.

WARNING
EXPLOSION HAZARD — DO NOT incinerate the battery or store at high temperatures. Serious injury or death could result.

1.7 General Manu Operation

Screen Composition

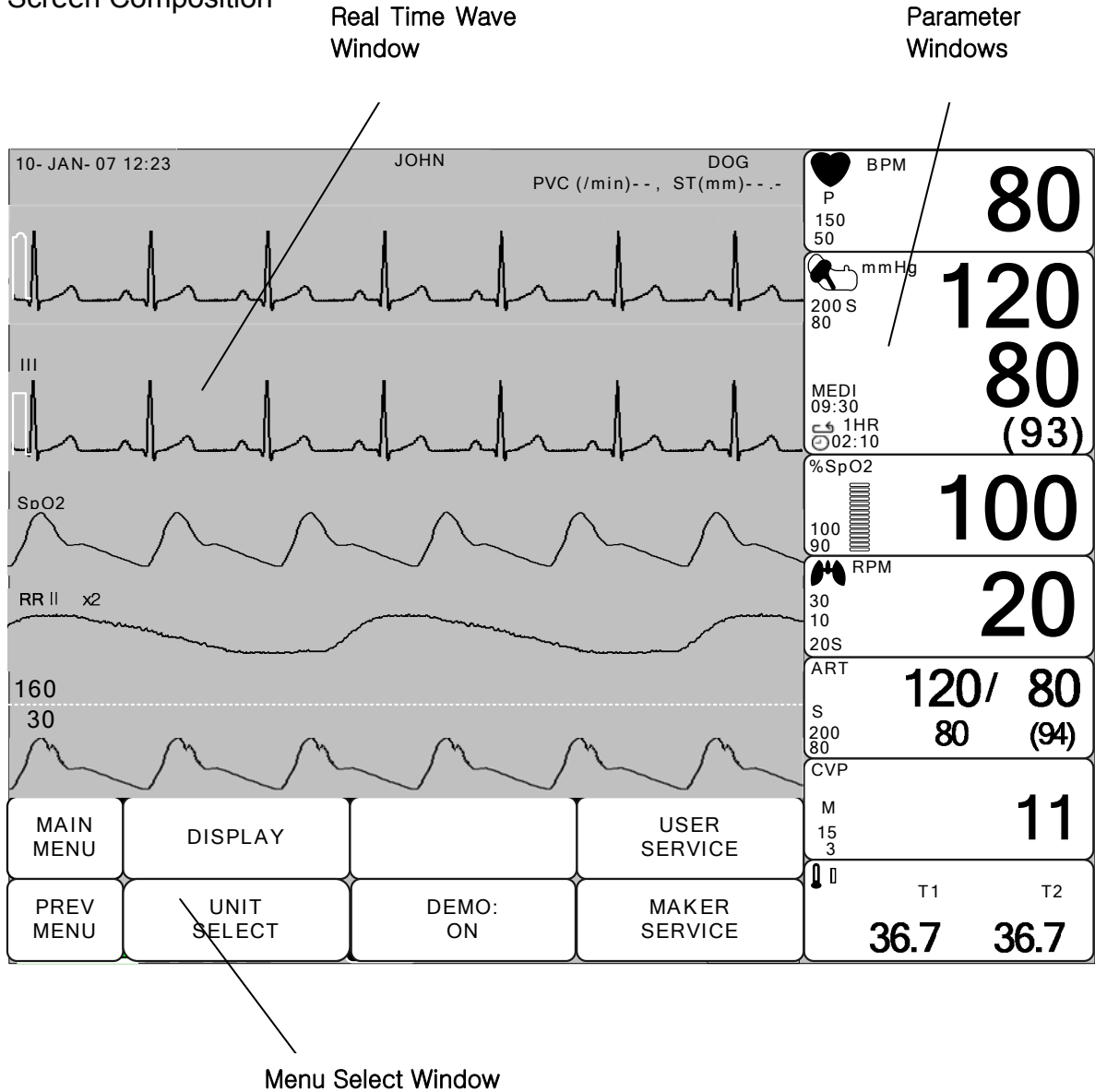

Real Time Wave Window : Displays measured results by up to three waves.

Menu Select Window : Menus appear when they are activated..

Parameter Window : Measured and setup data are displayed in five windows.

Menu Selection

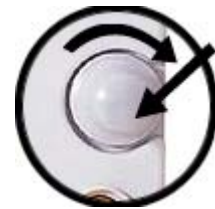
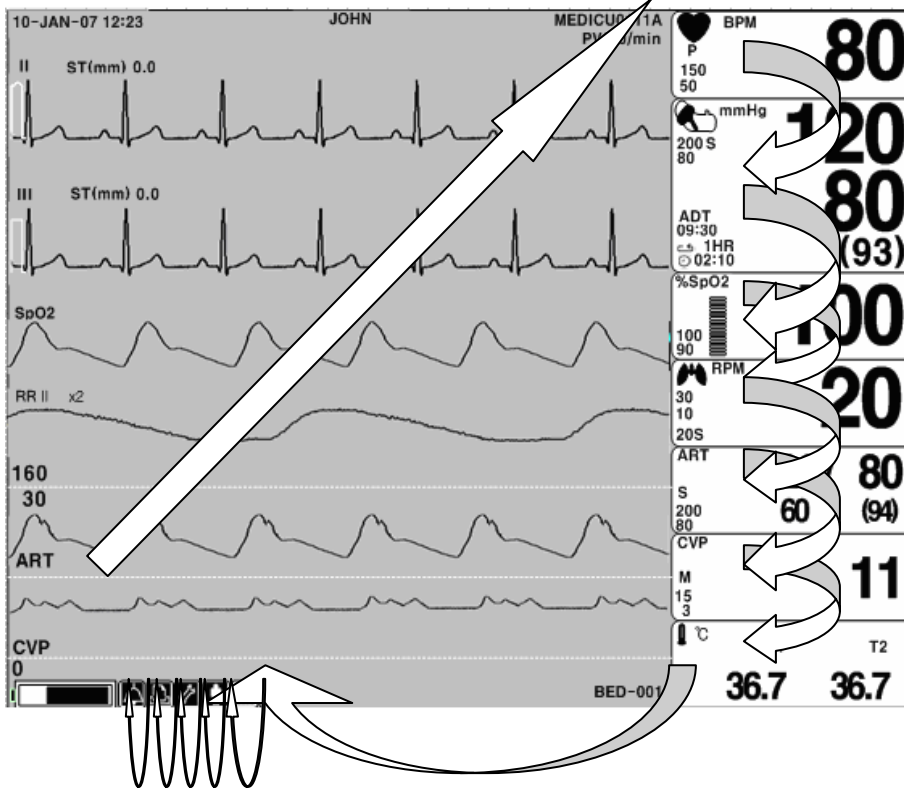

Turn or press the knob.

When the Trim Knob Key is turned, menus are selected in the order indicated above. The above screen shows that the MORE menu is selected. The menus move to the right in the order of MORE MENU → ECG → NIBP → SpO2 → RESP → TEMP. An inactivated window is jumped off.

Menu Composition

More Menu Window

When the additional menu is selected it will set and cancel the functions.

MAIN MENU	DISPLAY		USER SERVICE
PREV MENU	KEY SOUND: ON	DEMO: ON	MAKER SERVICE

Numerical value sign widow

This window displays a measured parameter, function setup, and the boundary of parameter values.

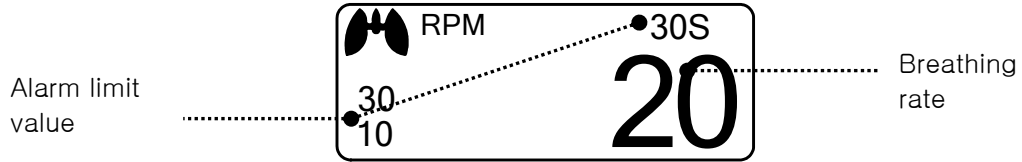

Menu selection by using Trim Knob key

As the key is turn to the right, the menu selection moves clockwise. As the key is turn to the left, the menu selection moves counterclockwise. The menu selection is activated when you depress Trim Knob key.

MAIN MENU	DISPLAY		USER SERVICE
PREV MENU	KEY SOUND: ON	DEMO : ON	MAKER SERVICE

Menu selection with arrows

Upward Movement: Turns the Trim Knob key to the left.

Downward Movement: Turns the Trim Knob key to the right.

Selection is made by pressing the Trim Knob key. One comes out of the menu after the selection.

MAIN MENU		ANIMAL TYPE: DOG	> HORSE DOG PUPPY CAT
PREV MENU	HEIGHT UNIT: CM		

When moving the within quadrilateral, the letter reverses, and the numeric value reflects immediately.

MAIN MENU	QRS VOLUME : OFF	>	OFF	60%
			10%	70%
PREV MENU			20%	80%
			30%	90%
			40%	100%
			50%	

Word feature menu

The following figure shows the screen where the word sequence menu is activated within the word sequence correction menu. Here, the cursor moves over the words when the Trim Knob key is turned in the clockwise direction.

MAIN MENU	SET UNIT NAME	█
PREV MENU		

The above figure shows how the cursor moves on the screen. The cursor moves according to the direction the Trim Knob Key is turned. Press the Trim Knob key if you want to change a letter currently on the screen.

MAIN MENU	SET UNIT NAME	A █
PREV MENU		

The above figure shows how the cursor is selected to change a letter. Right-hand turning of the Trim Knob Key makes it possible to select in the order of 0-9,A-Z, and a blank, while left-hand turning makes the movement in the opposite direction. Once a letter or a number is selected, the screen comes back to the condition where the same process of selection can be made. One may move to the menu item in the left of the screen to end the process, which is completed by pressing Trim Knob Key. After completion, the screen comes back to the earlier picture.

Operation menu

The setup value changes without a selection when the menu is moved.

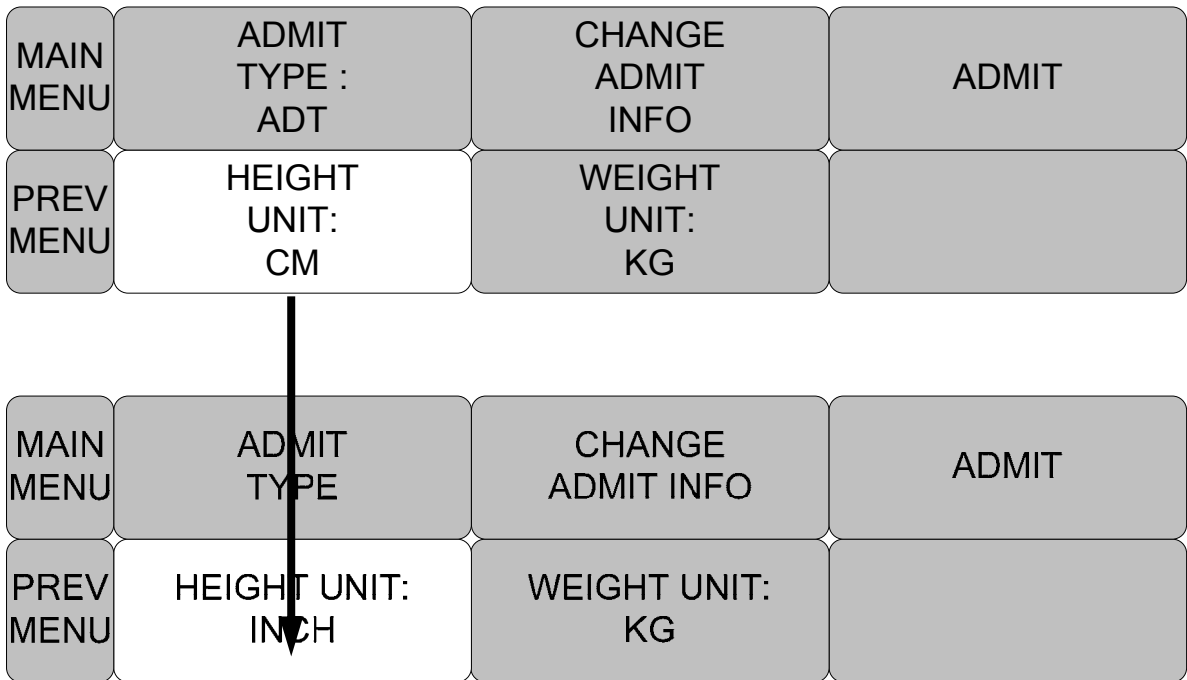

2. PATIENT/DATA MANAGEMENT

2.1 ADMIT

CHANGE ADMIT INFO

DISCHARGE

HEIGHT

WEIGHT

2.2 ALARM

ALL LIMITS

ALARM PRINT

ALARM VOLUME

ALARM LEVEL

ARRHYTHM LEVEL

ALARM REVIEW

ALARM LIST

SAVE ALARM LEVEL

NURSE CALL

2.1 ADMIT

CHANGE ANIMAL INFO

ANIMAL TYPE

HEIGHT UNIT

WEIGHT UNIT

DEFAULTS SETTING

MAIN MENU		CHANGE ANIMAL INFO	ANIMAL TYPE: DOG
PREV MENU	HEIGHT UNIT: CM	WEIGHT UNIT: KG	

ANIMAL TYPE

You can select animal type as follow.

HORSE : LARGE ANIMAL // DOG: MEDIUM ANIMAL

PUPPY : SMALL ANIMAL // CAT : TINY ANIMAL

MAIN MENU		CHANGE ANIMAL INFO	ANIMAL TYPE: DOG
PREV MENU	HEIGHT UNIT: CM	WEIGHT UNIT: KG	DEFAULTS SETTING
MAIN MENU		ANIMAL TYPE: DOG	> HORSE DOG PUPPY CAT
PREV MENU	HEIGHT UNIT: CM		

CHANGE ANIMAL INFORMATION

Hospital ID(11 letters for each), animal name (11 letters for each), sex (male or female), date of birth, weight, height, and animal ID (11 characters)

MAIN MENU		CHANGE ANIMAL INFO	ANIMAL TYPE: DOG
PREV MENU	HEIGHT UNIT: CM	WEIGHT UNIT: KG	DEFAULTS SETTING

CHANGE ANIMAL INFORMATION	
> RETURN	CONTENTS
LAST NAME	
FIRST NAME	
ANIMAL ID	
SEX	MALE
BIRTH DATE	1 – JAN - 2000
AGE	0
HEIGHT	50.0 CM
WEIGHT	20.0KG

DEFAULTS SETTING

Animal information and all Alarm limits change to standard.

MAIN MENU		CHANGE ANIMAL INFO	ANIMAL TYPE: DOG
PREV MENU	HEIGHT UNIT: CM	WEIGHT UNIT: KG	DEFAULTS SETTING

HEIGHT

Unit of height is set as Cm / Inch.

MAIN MENU		CHANGE ANIMAL INFO	ANIMAL TYPE: DOG
PREV MENU	HEIGHT UNIT: CM	WEIGHT UNIT: KG	DEFAULTS SETTING
MAIN MENU		CHANGE ANIMAL INFO	ANIMAL TYPE: DOG
PREV MENU	HEIGHT UNIT: INCH	WEIGHT UNIT: KG	DEFAULTS SETTING

WEIGHT

Unit of weight is set as Kg / LBS.

MAIN MENU		CHANGE ANIMAL INFO	ANIMAL TYPE: DOG
PREV MENU	HEIGHT UNIT: CM	WEIGHT UNIT: KG	DEFAULTS SETTING
MAIN MENU		CHANGE ANIMAL INFO	ANIMAL TYPE: DOG
PREV MENU	HEIGHT UNIT: CM	WEIGHT UNIT: LBS	DEFAULTS SETTING

2.2 ALARM

Alarm is divided into two, alarm for the patient's condition and for the product's condition.

The patient's alarm sounds when the diagnostic functions (ASYSTOLE, VTAC/VFIB, and VTAC) are detected. Each alarm sound differs in order and volume according to the levels of HIGH, MEDIUM, LOW and MESSAGE.

HIGH		-5	≡	300	≡		
MEDIUM		-3	≡	300	≡		
LOW		-1	≡	300	≡		
MESSAGE			≡	300	≡		



: Alarm sounds

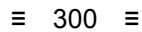

: Number flashes



: Waves are printed out



: Alarm lamp flashes

Alarm for the Product

The machine gives alarm sounds for its system with a related message flashing.

LOW  -1 ≡ Alarm Text ≡

ALARM LIMITS : The machine enables one to see and change the limits of alarm for all parameter functions.

ALARM PRINT : with an ON/OFF setup, the related information is printed out whenever an alarm is given.

ALARM VOLUME : volume of each alarm can be adjusted in 10 step.

ALARM LEVEL : Priority of each parameter alarm can be set up.

ALARM REVIEW : Shows the priority order information for all alarms of each measurement.

NURSE CALL : Set the ON/OFF feature of the NURSE CALL.

MAIN MENU	ALL LIMITS	ALARM PRINT: ON	ALARM VOLUME: OFF
PREV MENU	NURSE CALL: ON	ALARM LEVEL	ALARM REVIEW

It is able to see all the alarm range and change of measurement function.

ALL LIMITS

MAIN MENU	ALL LIMITS	ALARM PRINT: ON	ALARM VOLUME: OFF
PREV MENU	NURSE CALL: ON	ALARM LEVEL	ALARM REVIEW

ALL LIMITS							
RETURN	LIMITS	LOW	HIGH	PARA	UNITS	LOW	HIGH
HR	BPM	60	160	TEMP2	°F	96.8	104.0
SPO2-%	%	90	100	IBP1-S	mmHg	70	150
SPO2-R	BPM	60	160	IBP1-M	mmHg	50	115
RESP	RPM	15	100	IBP1-D	mmHg	40	100
RESP-A	SEC	0	20	IBP1-PR	mmHg	50	150
NIBP-S	mmHg	80	200	IBP2-S	mmHg	0	300
NIBP-M	mmHg	50	170	IBP2-M	mmHg	3	15
NIBP-D	mmHg	30	150	IBP2-D	mmHg	0	300
TEMP	°F	96.8	104.0	IBP2-PR	mmHg	50	160
ST	mm	-4.0	4.0	ETCO2	mmHg	25	50
PVC	/min	0	20	FICO2	mmHg	0	5

ALARM PRINT

Set ON/OFF functions automatically. When the alarm is activated the corresponding information is printed on heat sensitive paper.

MAIN MENU	ALL LIMITS	ALARM PRINT: ON	ALARM VOLUME: OFF
PREV MENU	NURSE CALL: ON	ALARM LEVEL	ALARM REVIEW

ALARM VOLUME

Set the alarm volume to be set at 10 grades.

MAIN MENU	ALL LIMITS	ALARM PRINT: OFF	ALARM VOLUME: OFF
PREV MENU	NURSE CALL: ON	ALARM LEVEL	ALARM REVIEW
MAIN MENU	ALARM VOLUME: OFF	> OFF	60%
		10%	70%
		20%	80%
PREV MENU		30%	90%
		40%	100%
		50%	

ALARM LEVEL

Set the order of priority in each alarm.

MAIN MENU	ALL LIMITS	ALARM PRINT: ON	ALARM VOLUME: OFF
PREV MENU	NURSE CALL: ON	ALARM LEVEL	ALARM REVIEW
MAIN MENU	PARAMETER LEVEL	ARRHYTHM LEVEL	
PREV MENU			

PARAMETER LEVEL

PARAMETER ALARM LEVELS			
RETURN	LEVELS	PARAMETER	LEVELS
HR	MEDIUM	IBP1-M	MESSAGE
SPO2-%	LOW	IBP1-D	MESSAGE
SPO2-R	MESSAGE	IBP2-S	MESSAGE
RESP	MESSAGE	IBP2-M	MESSAGE
RESP-A	MESSAGE	IBP2-O	MESSAGE
NIBP-S	MEDIUM	ETCO2	MESSAGE
NIBP-D	MEDIUM	LEAD FAULT	MESSAGE
NIBP-M	MEDIUM	LOW BATTERY	MEDIUM
TEMP	MESSAGE		
TEMP2	MESSAGE		
IBP1-S	MESSAGE		

ARRHYTH LEVEL

One can set up priorities when he or she uses the alarm for the diagnostic function.

MAIN MENU	PARAMETER LEVEL	ARRHYTH LEVEL	
PREV MENU			

ARRHYTHM ALARM LEVELS	
RETURN	ALARM LEVEL
ASYSTOLE	HIGH
VTAC/VFIB	HIGH
VTAC	HIGH
OTHERS	HIGH

ALARM REVIEW

After an alarm is triggered the alarms and data wave pattern can be reviewed. Set up for priority of each parameter alarm.

MAIN MENU	ALL LIMITS	ALARM PRINT: ON	ALARM VOLUME: OFF
PREV MENU	NURSE CALL: ON	ALARM LEVEL	ALARM REVIEW
MAIN MENU	ALARM LIST	SAVE CONDITION : HIGH	
PREV MENU			

ALARM LIST

When an alarm activates, this shows the order of the alarms.

MAIN MENU	ALARM LIST	SAVE CONDITION : HIGH	
PREV MENU			

10-MAR-2007 12:23 John PVC (0/min): 0 ST(mm): 0.0



BPM P 150 50 80
mmHg 200 S 80 120 80 (93)
ADT 09:30 1HR 02:10 %SpO2 100
RPM 30 10 20 S 20
ART 120/ 80 S 200 80 80 (94)
CVP M 15 3 11
T1 T2 36.7 36.7

ALARM REVIEW		
RETURN	TIME	KIND
ECG	2007/03/10 10:22:45	HIGH
SPO2	2007/03/08 12:25:34	LOW
RESP	2007/03/06 23:32:10	HIGH
ECG	2007/03/05 09:12:36	MEDIUM
ECG	2007/03/04 13:52:42	MESSAGE
ECG	2007/03/03 18:18:38	MESSAGE
SPO2	2007/03/02 20:12:36	MESSAGE
SPO2	2007/03/01 22:25:56	MEDIUM
RESP	2007/03/01 09:12:15	MESSAGE
RESP	2007/02/26 14:52:38	MESSAGE
NIBP	2007/02/24 09:12:36	LOW

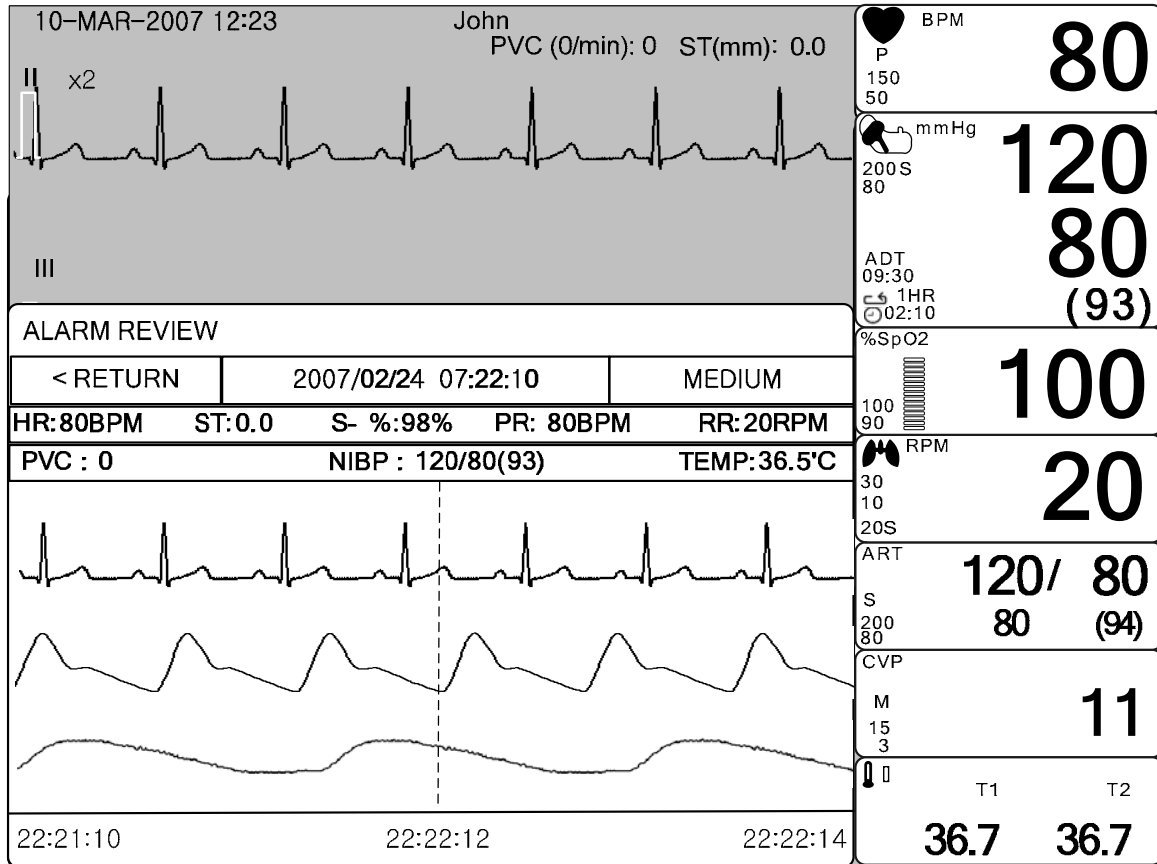

SAVE CONDITION

This determines the order in which triggered alarms are saved.

MAIN MENU	ALARM LIST	SAVE CONDITION : HIGH	
PREV MENU			
MAIN MENU	ALARM LIST	SAVE CONDITION : HIGH	MESSAGE LOW MEDIUM > HIGH
PREV MENU			

NURSE CALL

When an alarm is triggered, this activated the NURSE CALL function.

MAIN MENU	ALL LIMITS	ALARM PRINT: ON	ALARM VOLUME: OFF
PREV MENU	NURSE CALL: ON	ALARM LEVEL	ALARM REVIEW
MAIN MENU	ALL LIMITS	ALARM PRINT: ON	ALARM VOLUME: OFF
PREV MENU	NURSE CALL: OFF	ALARM LEVEL	ALARM REVIEW

3. SETUP

3.1 SETUP

DISPLAY

DEMO

USER SERVICE

MAKER SERVICE

3.1 SETUP

DISPLAY : screen set menu

USER SERVICE : This is the menu to set the connection used to interface with an external computer

MAKER SERVICE : This is the basic adjustment menu used to adjust the features of this product.

MAIN MENU	DISPLAY		USER SERVICE
PREV MENU	KEY SOUND: ON	DEMO: ON	MAKER SERVICE

DISPLAY

SET PARA : Measurement function selected.

WAVE SELECT : Set wave pattern source at the bottom of the WINDOW with LARGE

SET DATE & TIME: Set and change date and time.

HR SOURCE : Set and select ECG(HR) / SpO2(PR) source.

SWEEP SPEED : Set speed of ECG, SpO2 WAVE DISPLAY

MAIN MENU	SET PARA	WAVE SELECT: ECG	SET DATE & TIME
PREV MENU	SWEEP SPEED: 25mm/s		HR SOURCE: ECG

SET PARA

Select measurement function to use

MAIN MENU	SET PARA	WAVE SELECT: ECG	SET DATE & TIME
PREV MENU	SWEEP SPEED: 25mm/s		HR SOURCE: ECG

PARAMETER WINDOW SET	
RETURN	WINDOW ON/OFF
ECG	ON
SPO2	ON
RESP	OFF
NIBP	OFF
TEMP	ON
IBP I	ON
IBP II	ON
ETCO2	ON

WAVE SELECT

Select waveform to display in large parameter display.

MAIN MENU	SET PARA	WAVE SELECT: ECG	SET DATE & TIME
PREV MENU	SWEEP SPEED: 25mm/s		HR SOURCE: ECG

MAIN MENU	SET PARA	WAVE SELECT: ECG	> SPO2 RESP
PREV MENU	SWEEP SPEED: 25mm/s		

* The large parameter display at the selection of SpO2

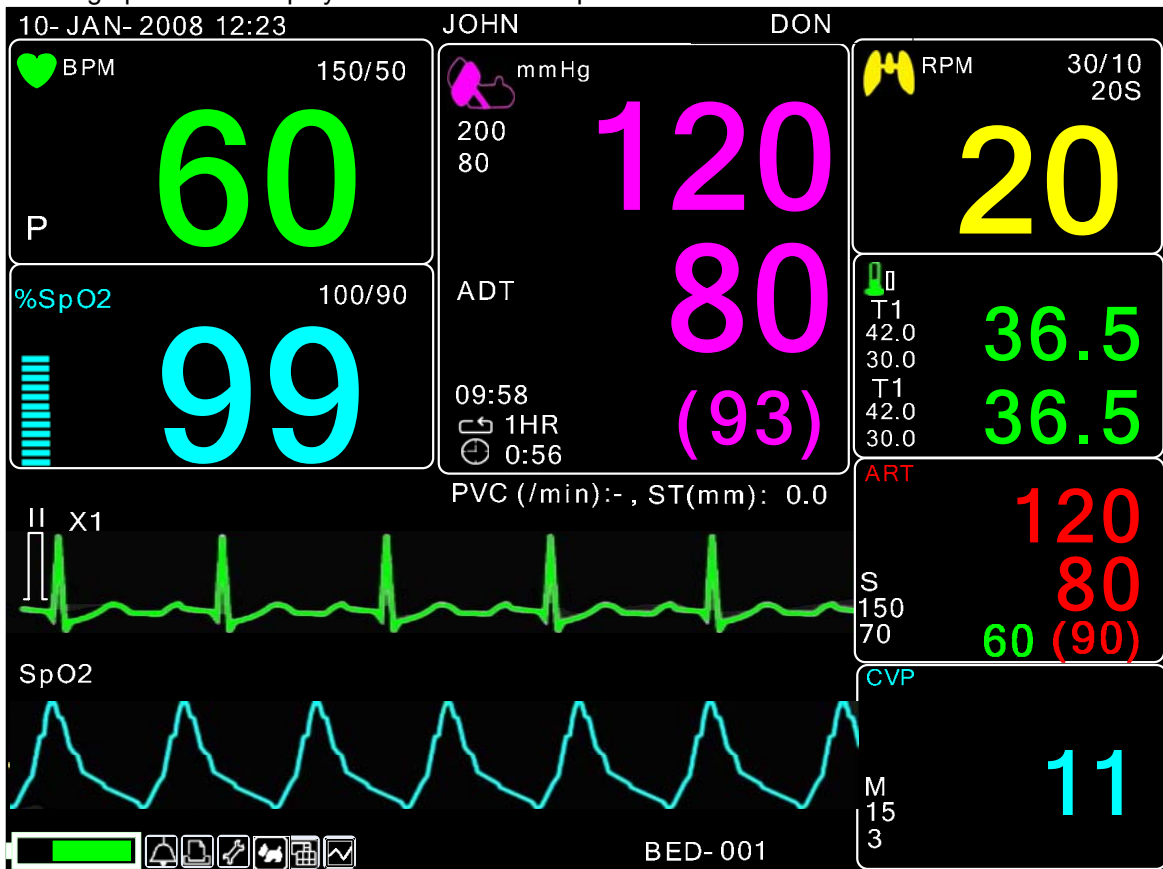

* The large parameter display at the selection of RESP

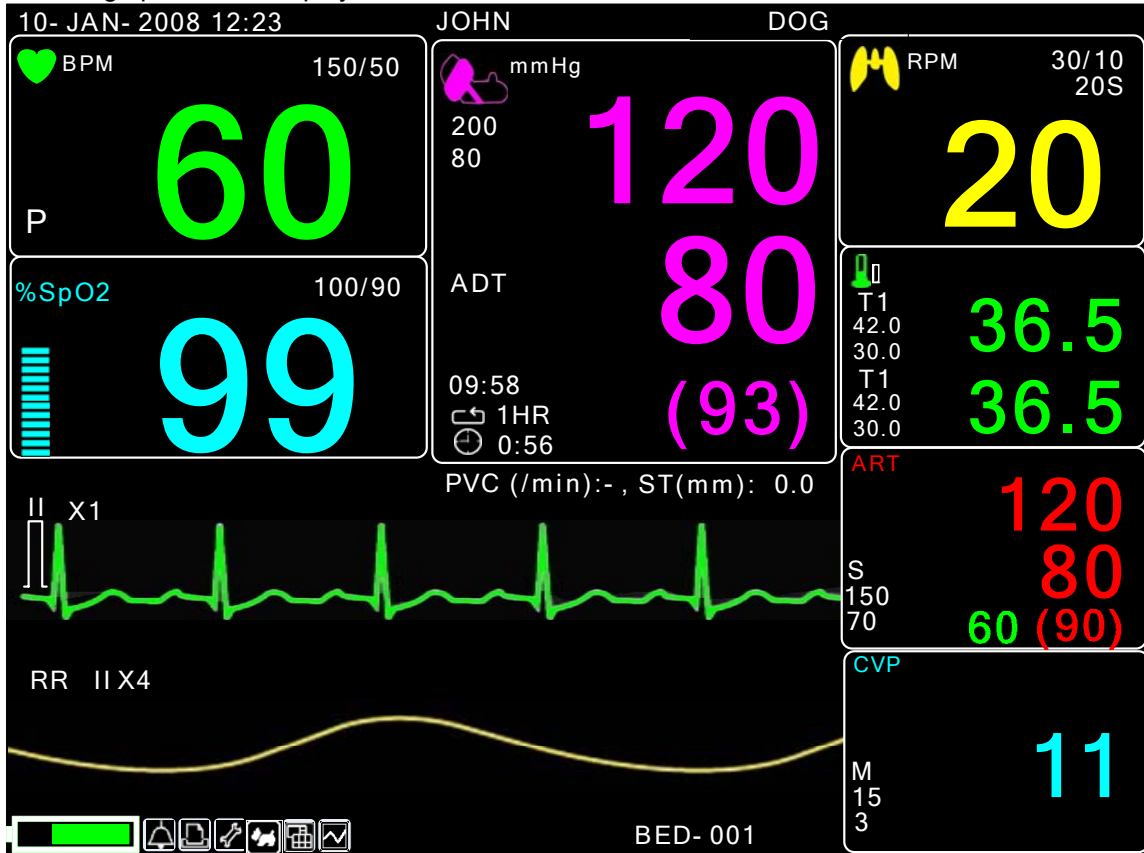

• The large parameter display at the selection of EtCO2

MAIN MENU	SET PARA	WAVE SELECT: SPO2	SET DATE & TIME
PREV MENU	SWEEP SPEED: 25mm/s		HR SOURCE: ECG
MAIN MENU	SET PARA	WAVE SELECT: SPO2	> SPO2 ETCO2
PREV MENU	SWEEP SPEED: 25mm/s		

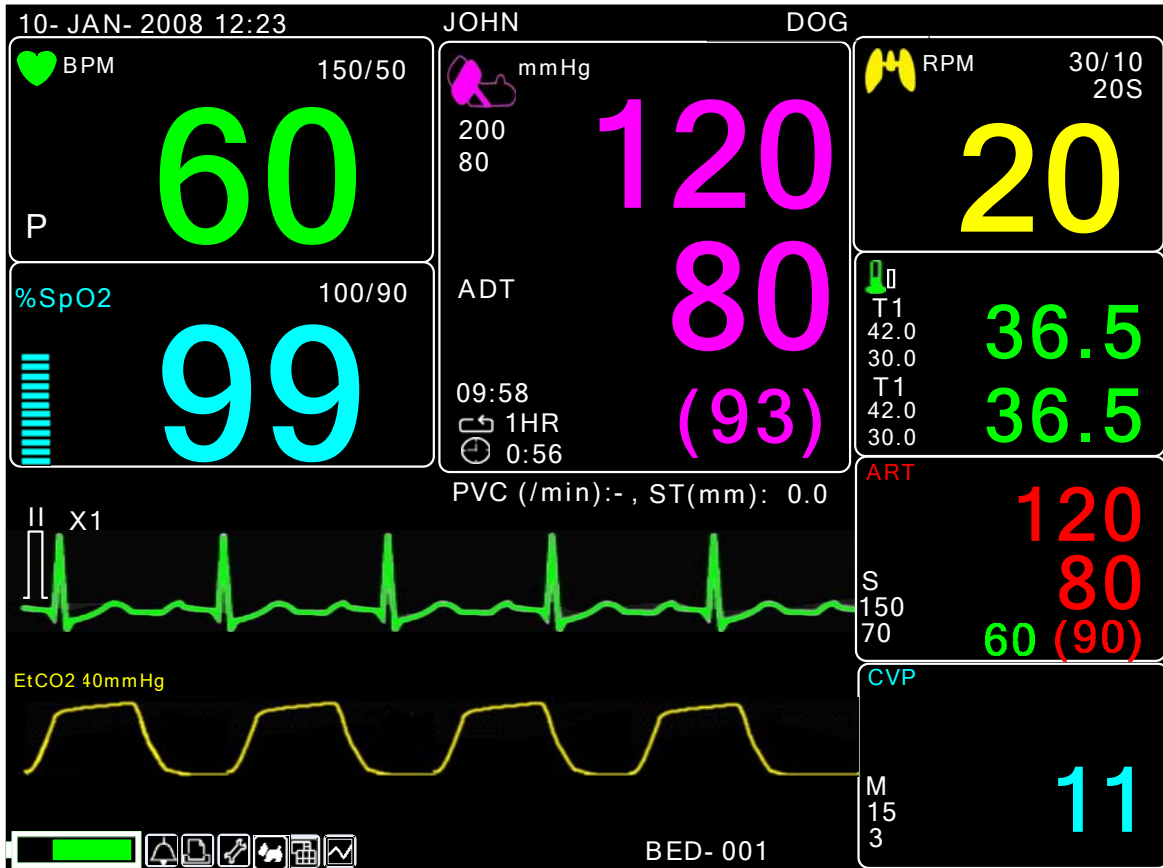

SET DATE & TIME

It has sub menu to set date and time.

MAIN MENU	SET PARA	WAVE SELECT: ECG	SET DATE & TIME
PREV MENU	SWEEP SPEED: 25mm/s		HR SOURCE: ECG

SET TIME

Set time of equipment.

MAIN MENU	SET TIME	SET DATE	
PREV MENU			
MAIN MENU	SET TIME:	10:58:01	
PREV MENU			

SET DATE

Set date of equipment

MAIN MENU	SET TIME	SET DATE	
PREV MENU			
MAIN MENU	SET DATE:	06-MAR-2007	
PREV MENU			

HR SOURCE

This menu is used to set the source that detects heart and pulse rate.

The source can select among ECG and SPO2.

MAIN MENU	SET PARA	WAVE SELECT: ECG	SET DATE & TIME
PREV MENU	SWEEP SPEED: 25mm/s		HR SOURCE: ECG
MAIN MENU	SET PARA	HR SOURCE: ECG	> ECG SPO2
PREV MENU	SWEEP SPEED: 25mm/s		

SWEEP SPEED

Set speed of drawing wave signal pattern in this widow.

MAIN MENU	SET PARA	WAVE SELECT: ECG	SET DATE & TIME
PREV MENU	SWEEP SPEED: 25mm/s		HR SOURCE: ECG
MAIN MENU	SWEEP SPEED: 25mm/s	> 6.25 mm/s 12.5 mm/s 25 mm/s 50 mm/s	SET DATE & TIME
PREV MENU			HR SOURCE: ECG

DEMO

Set ON/OFF DEMONSTRATION of equipment.

MAIN MENU	DISPLAY		USER SERVICE
PREV MENU	KEY SOUND: ON	DEMO: ON	MAKER SERVICE

USER SERVICE

The user is able to set the communication parameters, power supply filter, and patient's age.

MAIN MENU	DISPLAY		USER SERVICE
PREV MENU	KEY SOUND: ON	DEMO : ON	MAKER SERVICE
MAIN MENU	SET UNIT NAME	SET BED NUMBER : 00A	
PREV MENU	SYSTEM	AC FILTER: 50HZ	

SET UNIT NAME

Set up for Equipment name.

MAIN MENU	SET UNIT NAME	SET BED NUMBER : 00A	
PREV MENU	SYSTEM	AC FILTER: 50HZ	

MAIN MENU	SET UNIT NAME	█
PREV MENU		

SET BED NUMBER

Set up for patient bed number.

Allowable setters are from 0~9, A~Z.

MAIN MENU	SET UNIT NAME	SET BED NUMBER : 00A	
PREV MENU	SYSTEM	AC FILTER: 50HZ	
MAIN MENU	SET UNIT NAME	SET BED NUMBER : 00A	0 0 A
PREV MENU	SYSTEM		

AC FILTER

AC FILTER is function where you can set power supply frequency. This feature is required because power supply frequency can be different from one country to another. . (The selectable frequencies are 50Hz and 60Hz, OFF.)

MAIN MENU	SET UNIT NAME	AC FILTER 50HZ	> OFF 50HZ 60HZ
PREV MENU	SYSTEM		

SYSTEM

System able to change and verify Equipment version information and system information

SYSTEM INFO SET	
RETURN	CONTENTS
MAIN VER	1.00.BVCDDCB
EIA VER	1.01
NBP VER	1.0
CENTRAL	ON
HOST IP	192 . 168 . 030 . 077
DEVICE IP	192 . 168 . 030 . 100
SUBNET	255 . 255 . 255 . 000
GATEWAY	192 . 168 . 030 . 001
MAC ADDR	00 : 02 : BD : 80 : CB : 00
DISPLAY	LCD

MAKER SERVICE

Maker service is a menu is used by manufacturers.

MAIN MENU	DISPLAY		USER SERVICE
PREV MENU	KEY SOUND: ON	DEMO : ON	MAKER SERVICE

4. TREND

4.1 TREND

GRAPHIC TREND

TABLE TREND

TREND WINDOW SETUP

4.1 TREND

TREND shows saved data graphically displayed with numeric values.

Real-time data recording duration is 1 minute. Amount of saving time is for this data will be saving for 128hours.

MAIN MENU	GRAPHIC TREND	TABULAR TREND	TREND WINDOW SETUP
PREV MENU			

 : Move to main screen

 : Move within the tables

 : Move up to other analysis function

 : Move down to other analysis function

 : Time(HOURS) period set menu at Graphic Trend

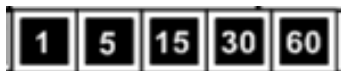
 : Time(MIN) period set menu at Tabular Trend

GRAPHIC TREND

Wave Data can be stored and seen according to section.

MAIN MENU	GRAPHIC TREND	TABULAR TREND	TREND WINDOW SETUP
PREV MENU			

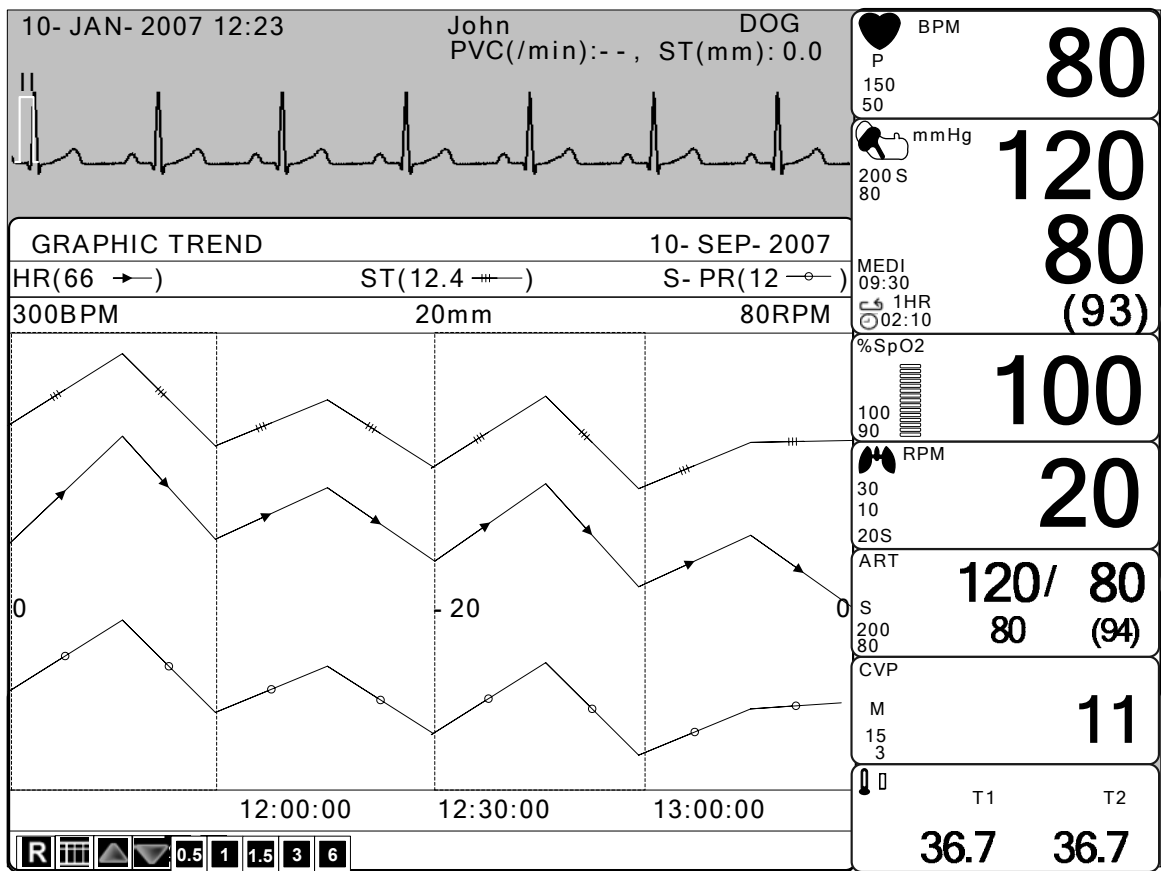

TIME PERIOD

One can set up and store data and time that one can see in a screen.

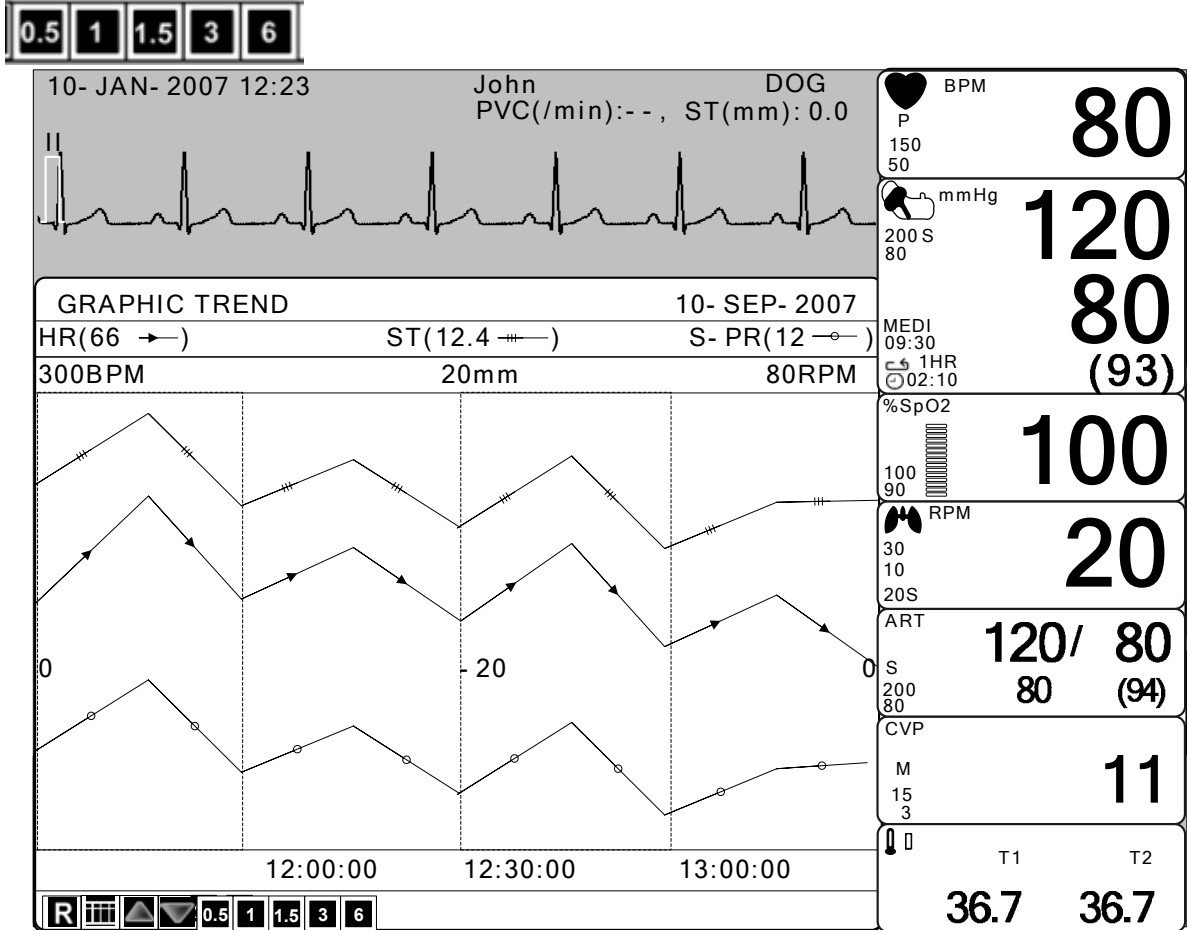

TABULAR TREND

One can see the stored data at the time previously set up.

MAIN MENU	GRAPHIC TREND	TABULAR TREND	TREND WINDOW SETUP
PREV MENU			

10- SEP- 2007 13:30 John DOG
 PVC(/min):-- , ST(mm): 0.0

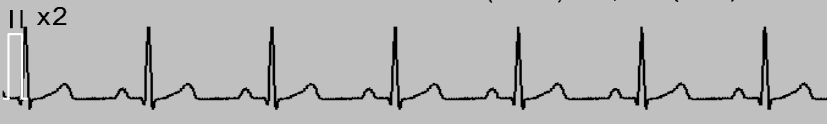

TABULAR TREND						13:00
	10- SEP 12:10	10- SEP 12:09	10- SEP 12:08	10- SEP 12:07	10- SEP 12:06	
HR	80	80	80	80	80	80
SPO2- %	99	99	99	98	99	99
SPO2- R	80	80	80	80	80	80
RESP	20	20	20	20	20	20
NIBP- S	120	120	120	120	120	120
NIBP- M	93	93	93	93	93	93
NIBP- D	80	80	80	80	80	80
TEMP	36.7	36.7	36.7	36.7	36.7	36.7
ST	0.0	0.0	0.0	0.0	0.0	0.0
PVC	0	0	0	0	0	0

BPM
P 150 50 80

mmHg
200 S 80 120

MEDI
09:30 1HR 02:10 80
(93)

%SpO2
100 90 100

RPM
30 10 20S 20

ART
S 200 80 120/ 80
80 (94)

CVP
M 15 3 11

T1 T2
36.7 36.7

R 1 5 15 30 60

TIME INTERVAL

One can store data and set up time.

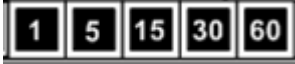

10- SEP- 2007 13:30 John DOG
PVC(/min):- -,ST(mm): 0.0

TABULAR TREND						10-SEP-2007 13:00	
	10- SEP 12:10	10- SEP 12:09	10- SEP 12:08	10- SEP 12:07	10- SEP 12:06		
HR	80	80	80	80	80	BPM	80
SPO2- %	99	99	99	98	99	mmHg	120
SPO2- R	80	80	80	80	80	80	80
RESP	20	20	20	20	20	(93)	100
NIBP- S	120	120	120	120	120	RPM	20
NIBP- M	93	93	93	93	93	ART	120/ 80
NIBP- D	80	80	80	80	80	S	80 (94)
TEMP	36.7	36.7	36.7	36.7	36.7	CVP	11
ST	0.0	0.0	0.0	0.0	0.0	M	
PVC	0	0	0	0	0	T1	36.7
						T2	36.7

TREND WINDOW SETUP

Set the trend display window that will show the real time wave window.

MAIN MENU	GRAPHIC TREND	TABULAR TREND	TREND WINDOW SETUP
PREV MENU			

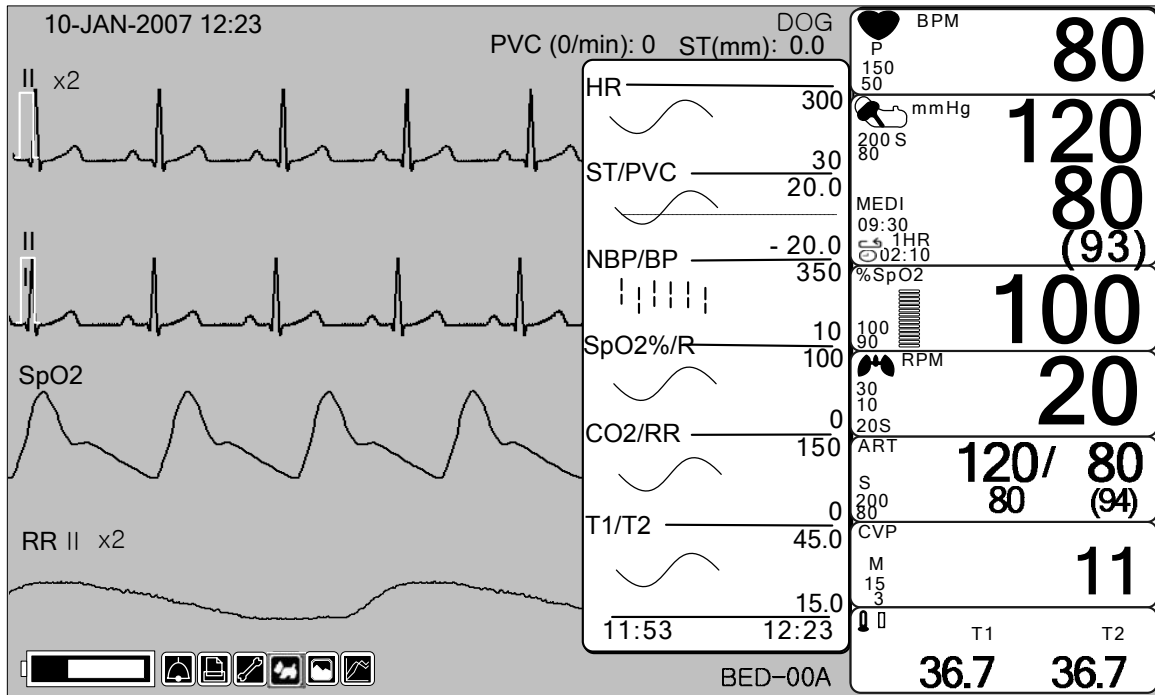

TIME PERIOD

Set visible time period in a screen.

MAIN MENU	TIME PERIOD: 30MINS	SET TREND PARA	
PREV MENU			
MAIN MENU	TIME PERIOD: 30MINS	> 30MINS 60MINS 90MINS 3HOUR 6HOUR 12HOUR	
PREV MENU			

SET TREND PARA

Set parameter for display in a screen.

MAIN MENU	TIME PERIOD: 30MINS	SET TREND PARA	
PREV MENU			

PARAMETER WINDOW SET	
RETURN	ON / OFF
HR	ON
ST	ON
SPO2	ON
PR	ON
RESP	ON
NIBP	ON
TEMP	ON
IBP I	ON
IBP II	ON
ETCO2	OFF

TREND PRINT

Graphic: select the number which selects a graphic trend and press print to prints the selected trend.
 Table: select the table number to be print and press print to receive print all the data in the selected patient admit (Admit) table.

5. ECG

5.1 Outline

Color and Name for Each Cable Size
ECG Connector Location and Measurement Cable
5 Lead Electrode Attached Location
3 Lead Electrode Attached Location
Method to Attach Electrode to Baby

5.2 ECG Data Window

5.3 ECG Data Setup

TRACE 1 LEAD SELECT
ALARM LIMIT
ALARM
QRS VOLUME
ECG SIZE
HEART RATE SOURCE
ECG SPEED
ANALYSIS SETTING

5.1 Introduction

It calculates the heart rate with 3 or 5 leads ECG signal acquisition and perform the alarm according to the setting value.

Colors and Standards of Cables

Leadwire	AHA Color code	AHA Label	IEC Color code	IEC Label
Right arm	White	RA	Red	R
Left arm	Black	LA	Yellow	L
Right leg	Green	RL	Black	N
Left leg	Red	LL	Green	F
V1(precordial)	Brown	V1	White	C1

AHA : American Heart Association (U.S.A. standard)

IEC : International Electro technical Commission (Europe standard)

Position of ECG Connector and Measuring Cable

ECG connector +detect cable

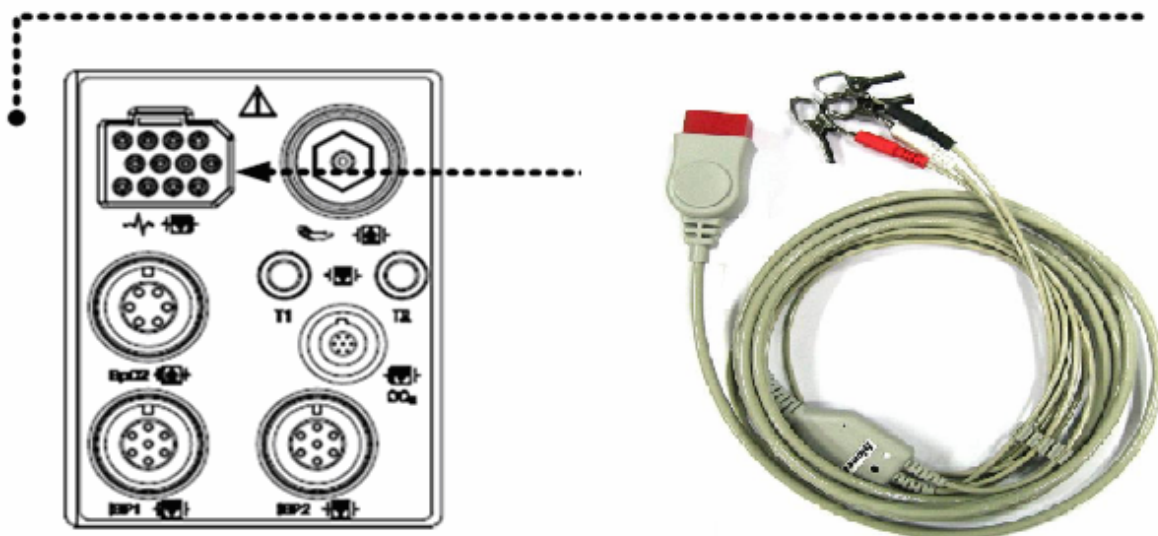

Attaching Electrodes to the Animal

1. Shave excess hair. With a piece of cotton pad moistened with alcohol, clean the animal's skin where the electrodes should be mounted. Avoid wrinkled or uneven skin areas. Wipe off the alcohol with a dry cotton pad.
2. Open the electrode package and take out the electrode.
3. Remove the backing paper from the electrode. Be careful not to touch the adhesive side.
4. Attach the disposable electrode to the previously cleaned skin. Avoid wrinkled and uneven skin areas.
5. The electrode lead which is connected to the monitor onto the electrode.
6. Fasten the electrode lead to the skin with surgical tape with an extra length of wire between the tape and the electrode. This prevents body movement from moving the electrode lead.

Note

- ✓ To maintain good contact between the electrode and skin, check that the paste of the disposable electrode is not dry.
- ✓ When contact of the disposable electrode becomes poor, replace the electrode with a new one immediately. Otherwise, contact impedance between the skin and electrode increase and the correct ECG cannot be obtained.
- ✓ If the contact is bad before the expiration date on the package, replace the electrode with a new one.
- ✓ To obtain a stable ECG waveform rub the skin with "skin Pure" skin preparation gel or tincture of Benzoin.
- ✓ Shall use only the CE certified disposable electrode.

Choosing an ECG lead for Arrhythmia Monitoring

It is very important to select a suitable lead for arrhythmia monitoring.

Guidelines for non-paced animals:

- ✓ QRS should be tall and narrow(recommended amplitude > 0.5mV)
- ✓ R wave should be above or below the baseline (but not bi-phasic)
- ✓ T wave should be smaller than 1/3 R-wave height.
- ✓ The P-wave should be smaller than 1/5 R-wave height.

To prevent detection of P-waves or baseline noises as QRS complexes, the minimum detection level for QRS complexes is set at 0.15mV. Adjusting the ECG wave size on the monitor display(gain adjustment)does not affect the ECG signal which is used for arrhythmia analysis. If the ECG signal is too small, you may get false alarms for asystole.

Information on the ECG waveform

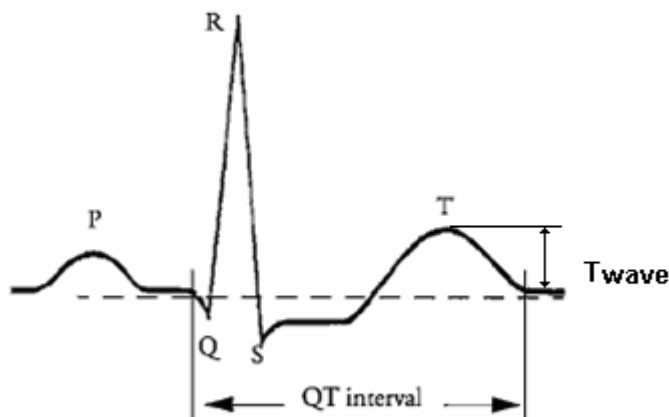

When ECG signal is 80bpm T-wave duration is 180ms, and the QT interval is 350ms.

Position of 3-Lead Wire Electrode

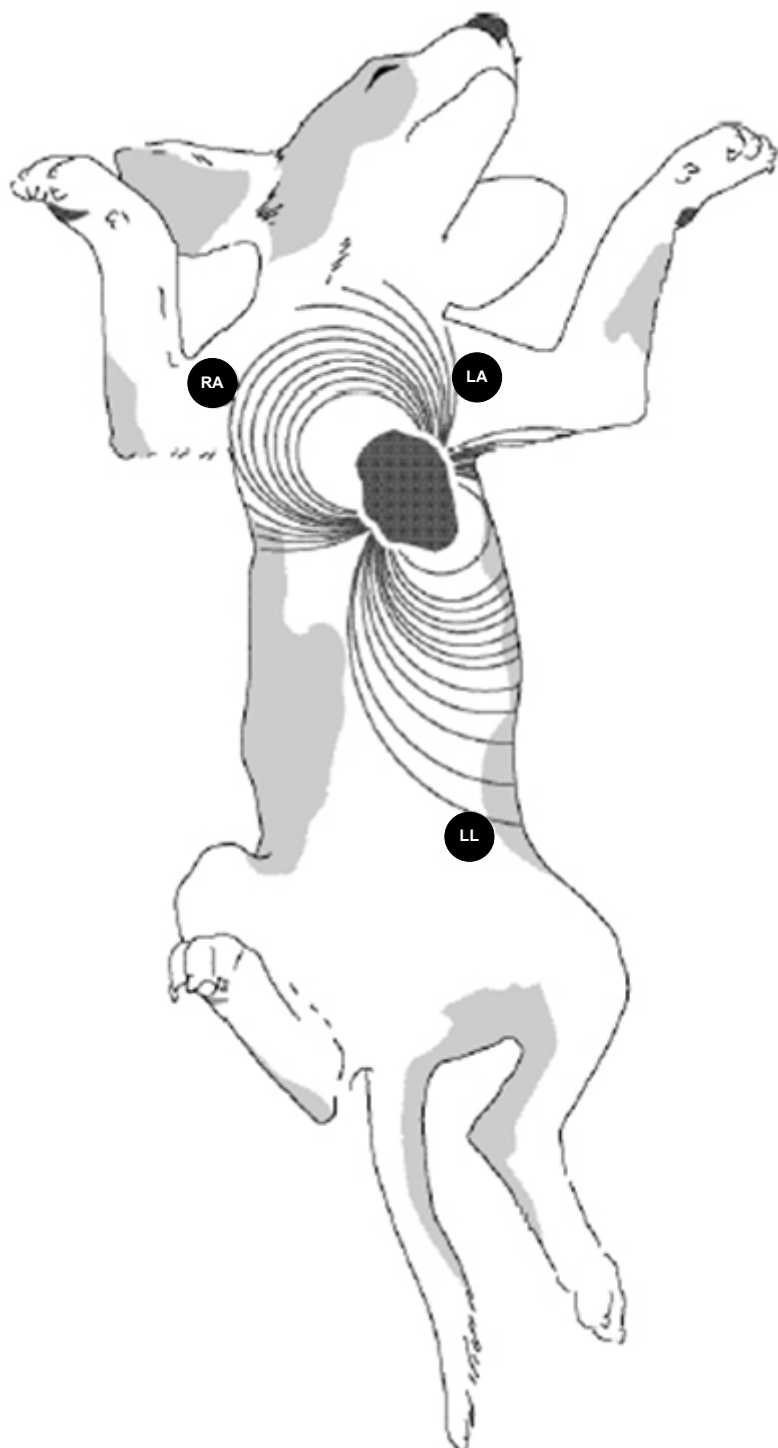

Position of 5-Lead Wire Electrode

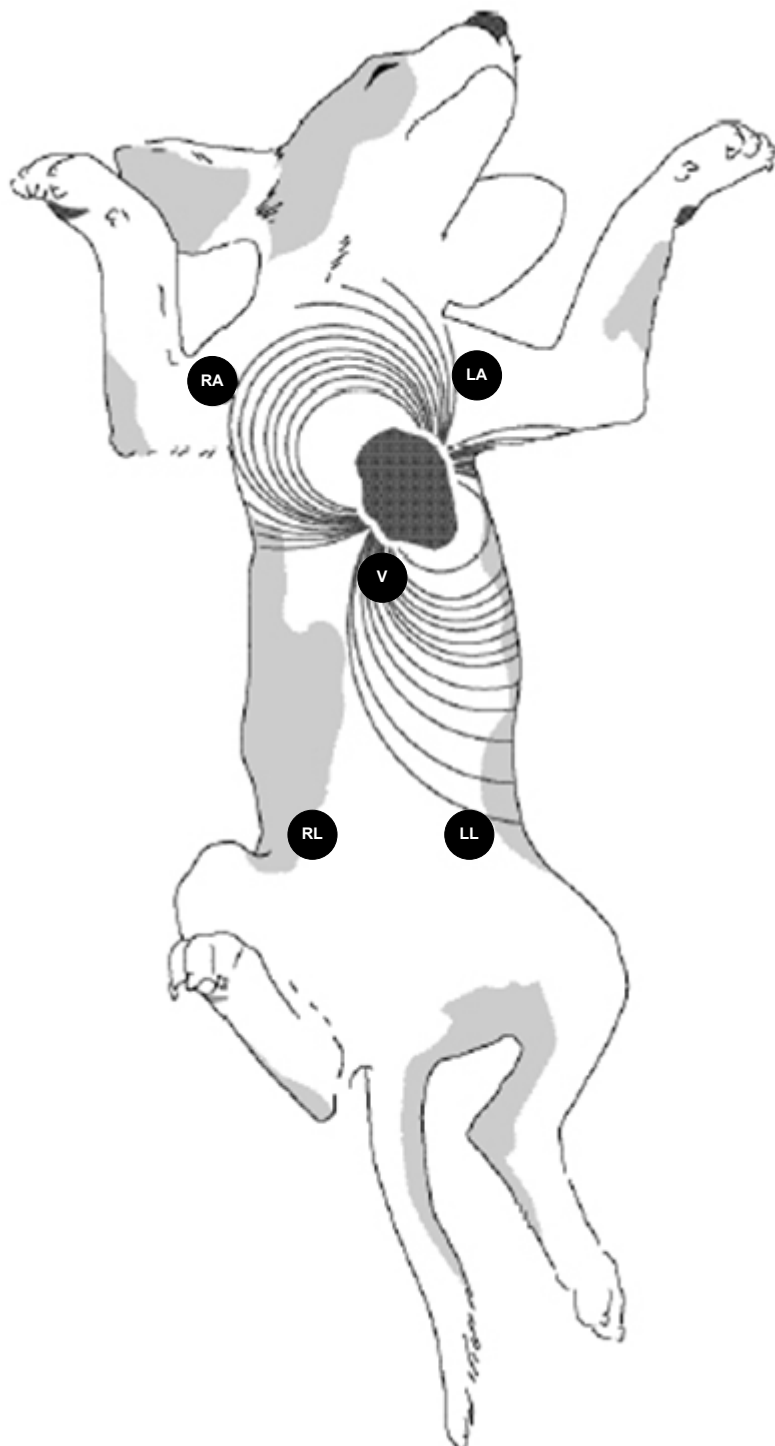

5.2 ECG Data Window

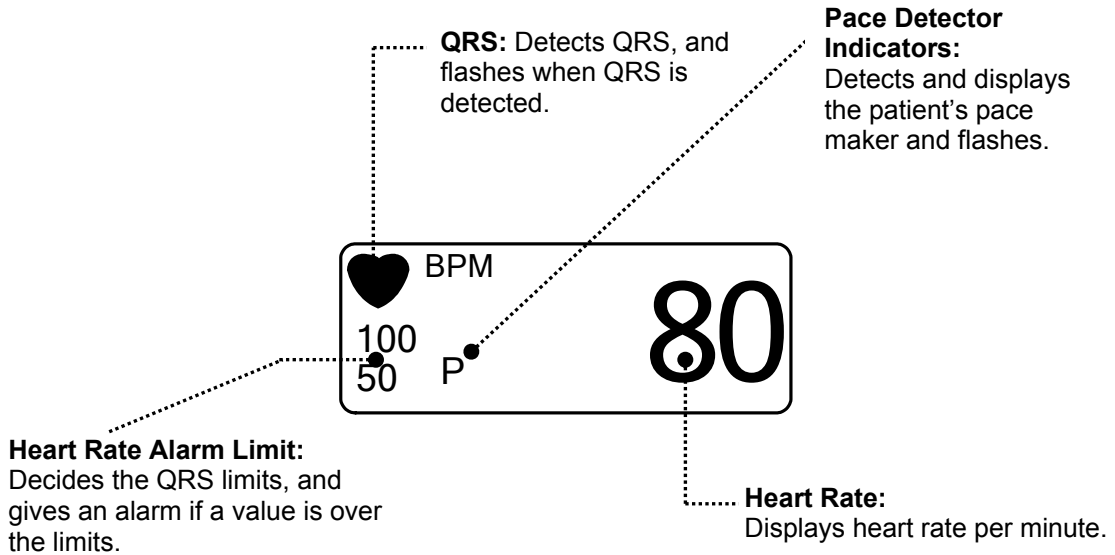

Note

ECG Wave Display is always on when the cable is connected.

The heart rate is calculated by a moving average. The monitor detects 8 consecutive beats, averages the R-R intervals of the latest 8 beats and uses this average to calculate the current heart rate. When a new beat is detected, the heart rate is recalculated using the latest 8 beats. The heart rate display is updated every 3 seconds.

Heart rate meter updates a new heart rate for a step increase or decrease in 10 seconds maximum.

When ventricular tachycardia is detected, the alarm set in 5 seconds maximum.

Check that the delay time of the output signal (alarm trigger 80ms maximum) is within the range of the connected equipment.

Safety Precautions

Warning

CABLES — Route all cables away from patient's throat to avoid possible strangulation.

CONDUCTIVE CONNECTIONS — Extreme care must be exercised when applying medical electrical equipment. Many parts of the human/machine circuit are conductive, such as the patient, connectors, electrodes, transducers. It is very important that these conductive parts do not come into contact with other grounded, conductive parts when connected to the isolated patient input of the device. Such contact would bridge the patient's isolation and cancel the protection provided by the isolated input. In particular, there must be no contact of the neutral electrode and ground.

DEFIBRILLATION — Do not come into contact with patients during defibrillation. Otherwise serious injury or death could result.

To avoid the risk of serious electrical burn, shock, or other injury during defibrillation, all persons must keep clear of the bed and must not touch the patient or any equipment connected to the patient.

After defibrillation, the screen display recovers within 10seconds if the correct electrodes are used and applied in accordance with the manufacturer's instructions.

ECG cables can be damaged when connected to a patient during defibrillation. Check cables for functionality before using them again.

The peak of the synchronized defibrillator discharge should be delivered within 60ms of the peak of the R wave. The signal at the ECG output on the patient monitors is delayed by a maximum of 30ms.

If the ECG waveform on the screen is too unstable to synchronize with the patient's heart beat because of the following reason, remove the cause of an alarm, message, or unstable ECG, and then use a stable ECG lead for synchronization.

- ✓ ECG electrode is detached or broken. Lead wire is detached or broken.
- ✓ Lead wire moves. AC interference, EMG noise or noise from ESU is superimposed.
- ✓ Connection cable is broken or has a short circuit. Connector has poor contact.

INTERFACING OTHER EQUIPMENT — Devices may only be interconnected with each other or to parts of the system when it has been determined by qualified biomedical engineering personnel that there is no danger to the patient, the operator, or the environment as a result. In those instances where there is any element of doubt concerning the safety of connected devices, the user must contact the manufacturers concerned (or other informed experts) for proper use. In all cases, safe and proper operation should be verified with the applicable Manufacturer's instructions for use, and system standards IEC 60601-1-1/EN 60601-1-1 must be complied with.

Electrosurgery Unit

- ✓ Electrosurgical units(ESU) emit a lot of RF interference. If the monitor is used with an ESU,RF interference may affect the monitor operation.
- ✓ Locate the monitor as far as possible from the ESU. Locate them on opposite sides of the operating table, if possible.
- ✓ Connect the monitor and ESU to different AC outlets located as far as possible from each other.
- ✓ When using this monitor with an electrosurgical unit, its return plate and the electrodes for monitoring must be firmly attached to the patient. If the return plate is not attached correctly,it may burn the patient's skin where the electrodes are attached.

5.3 ECG Data Setup

A setup window appears at lower part of the screen when the Trim Knob Key is pressed in the ECG Parameter Window.

Selection is made by pressing the Trim Knob Key, while movement across the menu is performed by turning the key either clock or anticlockwise.

MAIN MENU	LEAD SELECT		ALARM
PREV MENU	DISPLAY	ANALYSIS SETTING	QRS VOLUME : OFF

LEAD SELECT

Select channels from I to V in ECG

Lead I, II, III show up in case of connecting 3-Leads ECG Cable.

Lead I, II, III, aVR, aVL, aVF, V show up in case of connecting 5-Leads ECG Cable.

MAIN MENU	LEAD SELECT		ALARM
PREV MENU	DISPLAY	ANALYSIS SETTING	QRS VOLUME : OFF
MAIN MENU	TRACE I : I	TRACE II : II	TRACE III : NONE
PREV MENU			

LEAD 1 SELECT MENU

MAIN MENU	TRACE I : I	TRACE II : II	TRACE III : NONE
PREV MENU			
MAIN MENU	LEAD SELECT : I	> I II III	aVR aVL aVF V
PREV MENU			

LEAD 2 SELECT MENU

MAIN MENU	TRACE I : I	TRACE II : II	TRACE III : NONE
PREV MENU			
MAIN MENU	LEAD SELECT : II	> I II III	aVR aVL aVF V
PREV MENU			

LEAD 3 SELECT MENU

MAIN MENU	TRACE I : I	TRACE II : II	TRACE III : III
PREV MENU			
MAIN MENU	LEAD SELECT : III	I	aVR
PREV MENU		II	aVL
		> III	aVF
			V

3 traces are displayed at once in case of connecting 5-Leads ECG cable and IBP para OFF

3 difference traces are displayed in case of selecting all 3 traces in LEAD SELECT menu.

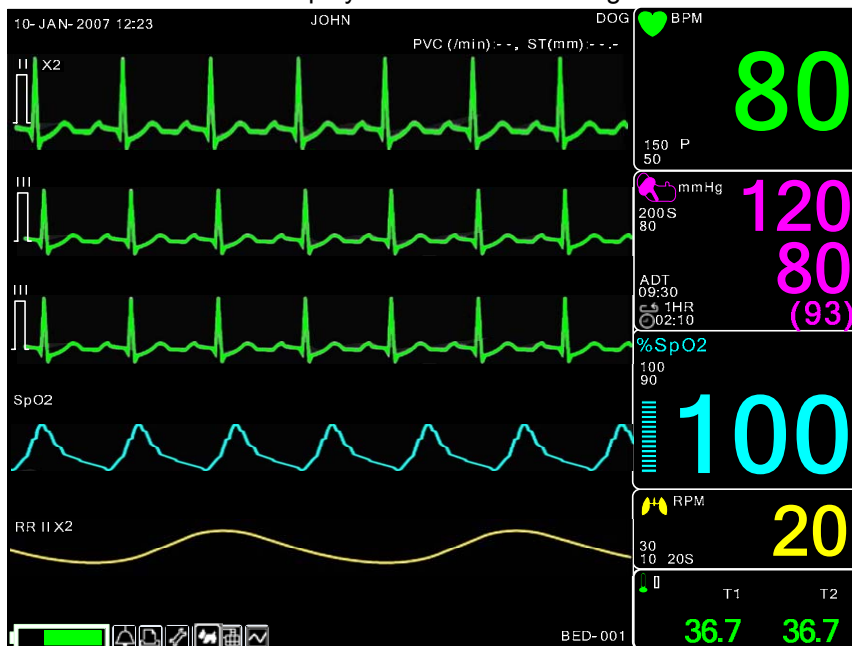

Two different traces are displayed in case of selecting only 2 traces in LEAD SELECT menu.

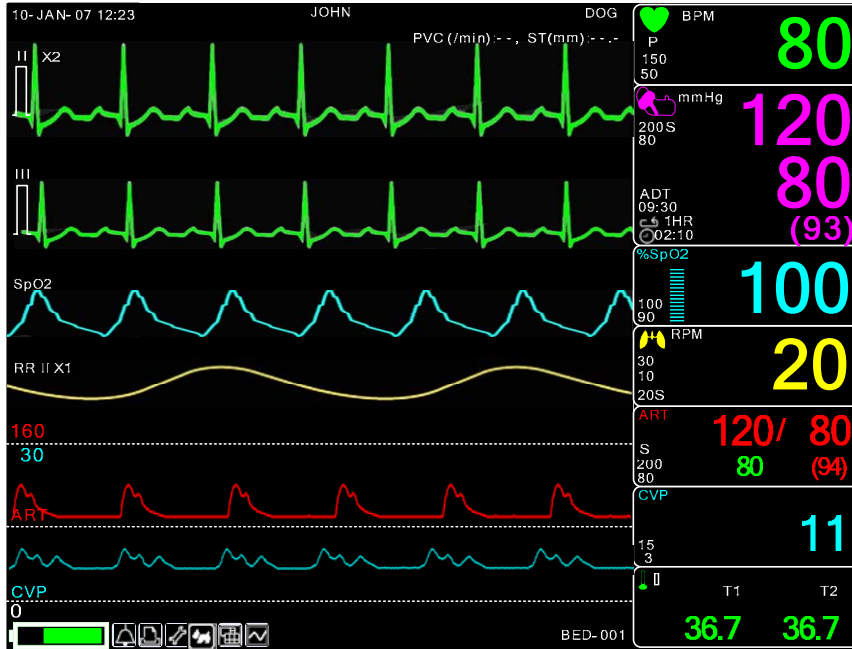

The two traces of one lead are displayed in case of selecting only one lead in LEAD SELECT menu.

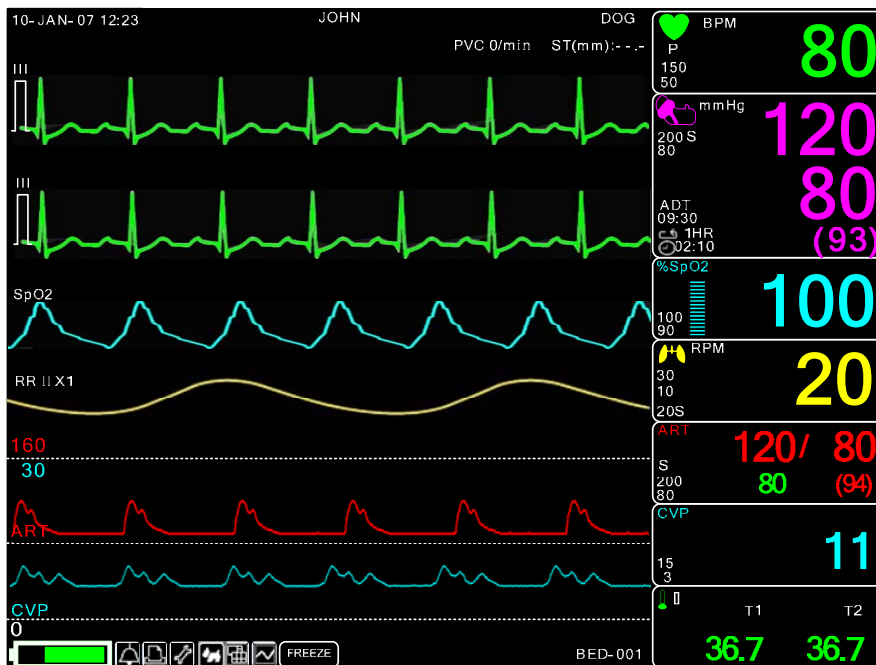

ALARM LIMIT

Alarm Limit is 0 ~ 350.

MAIN MENU	LEAD SELECT : II		ALARM
PREV MENU	DISPLAY	ANALYSIS SETTING	QRS VOLUME : OFF
MAIN MENU	ALARM LIMIT	ALARM SOUND	
PREV MENU			

ECG ALARM LIMIT			
RETURN	UNITS	LOW	HIGH
HR	BPM	60	120

ALARM SOUND

Set ON/OFF of ECG alarm sound.

MAIN MENU	LEAD SELECT		ALARM
PREV MENU	DISPLAY	ANALYSIS SETTING	QRS VOLUME : OFF

ECG ALARM SOUND	
> RETURN	ECG ALARM SOUND
HR	ON
ARRHYTHMIA	ON
ST	ON
PVC	OFF

QRS VOLUME

Move the Key to select a volume rate from OFF, 10% to 100%.

MAIN MENU	LEAD SELECT		ALARM
PREV MENU	DISPLAY	ANALYSIS SETTING	QRS VOLUME : OFF

MAIN MENU	QRS VOLUME : OFF	>	OFF	60%
			10%	70%
PREV MENU			20%	80%
			30%	90%
			40%	100%
			50%	

DISPLAY

Set the sweep speed and waveform size.

MAIN MENU	LEAD SELECT		ALARM
PREV MENU	DISPLAY	ANALYSIS SETTING	QRS VOLUME : OFF

ECG SWEEP SPEED

ECG speed is 25 mm/s.

Speed is changeable to 6.25, 12.5, 25, 50mm/s.

MAIN MENU	SWEEP SPEED : 25 mm/s	ECG SIZE : X1	HR SOURCE: ECG
PREV MENU	7CHANNEL VIEW :OFF		
MAIN MENU	SWEEP SPEED : 25 mm/s	>	HR SOURCE: ECG
PREV MENU			

ECG SIZE

The size is changeable to X0.25, X0.5, X1, X2, X4.

MAIN MENU	SWEEP SPEED : 25 mm/s	ECG SIZE : X1	HR SOURCE: ECG
PREV MENU	7CHANNEL VIEW :OFF		
MAIN MENU	SWEEP SPEED : 25 mm/s	ECG SIZE : X1	x 0.25 x 0.5 > x 1 x 2 x 4
PREV MENU	7CHANNEL VIEW :OFF		

HR SOURCE

MAIN MENU	SWEEP SPEED : 25 mm/s	ECG SIZE : X1	HR SOURCE: ECG
PREV MENU	7CHANNEL VIEW :OFF		
MAIN MENU	SWEEP SPEED : 25 mm/s	HR SOURCE: ECG	> ECG SPO2
PREV MENU	7CHANNEL VIEW :OFF		

7CHANNEL VIEW

Set 7Ch ECG View mode.

ECG traces are only displayed when 7CHANNEL VIEW is 'On'.

MAIN MENU	SWEEP SPEED : 25 mm/s	ECG SIZE : X1	HR SOURCE: ECG
PREV MENU	7CHANNEL VIEW :ON		
MAIN MENU	SWEEP SPEED : 25 mm/s	ECG SIZE : X1	HR SOURCE: ECG
PREV MENU	7CHANNEL VIEW :OFF		

The display when 7CHANNEL VIEW is 'OFF'

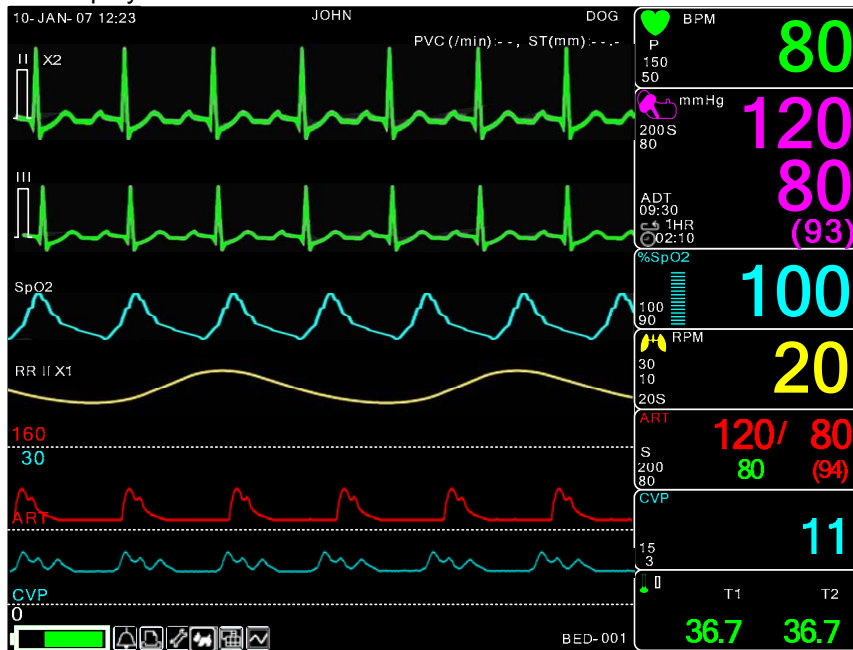

The display when 7CHANNEL VIEW is 'ON'

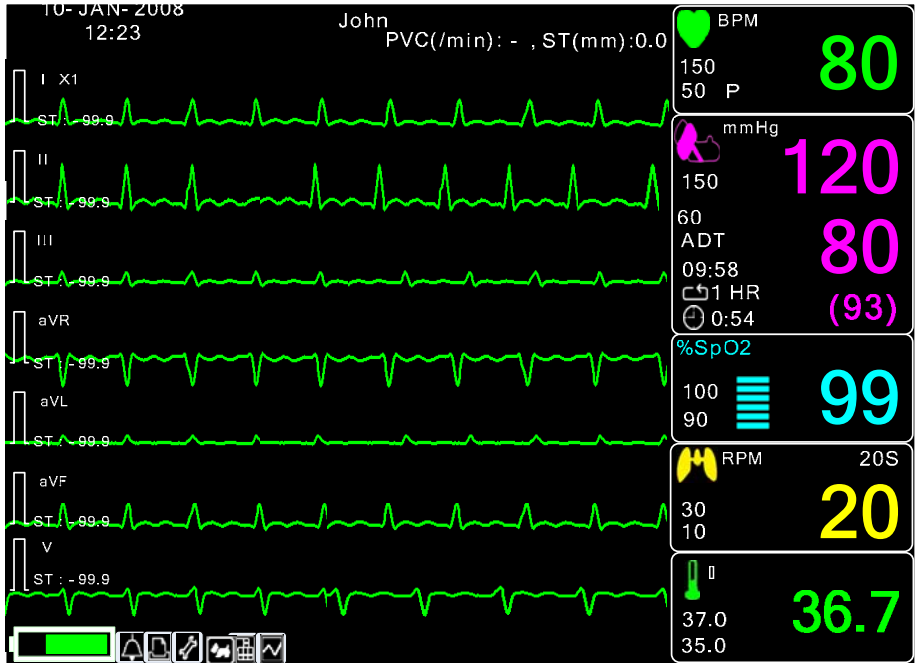

ANALYSIS SETTING

Analysis setting is divided to 3 menus.

ECG FILTER : One may select from three frequency types for WAVE FILTER.

MONITOR 0.5Hz ~ 40Hz

MODERATE 0.5Hz ~ 25Hz

MAXIMUM 5Hz ~ 25Hz

DIAGONOSIS 0.05Hz ~ 120Hz

MAIN MENU	LEAD SELECT		ALARM
PREV MENU	DISPLAY	ANALYSIS SETTING	QRS VOLUME : OFF

MAIN MENU	ECG FILTER : MONITOR	PACE : OFF	ARRHYTHM : OFF
PREV MENU		PVC SETTING	ST SETTING
MAIN MENU	ECG FILTER : MONITOR	> MONITOR MODERATE MAXIMUM DIAGONOSIS	
PREV MENU			

PACE : Sets up ON/OFF to indicate that the patient has PACE.

The PACE menu option enables/disables the pacemaker detection program.

MAIN MENU	ECG FILTER : MONITOR	PACE : OFF	ARRHYTHM : OFF
PREV MENU		PVC SETTING	ST SETTING

Be aware of the following when monitoring a patient with a pacemaker.

Warning
<p>FALSE CALLS—False low heart rate indicators or false asystole calls may result with certain pacemakers because of electrical overshoots.</p> <p>MONITORING PACEMAKER PATIENTS—Monitoring of pacemaker patients can only occur with the pace program activated.</p> <p>PACEMAKER SPIKE—An artificial pacemaker spike is displayed in place of the actual pacemaker spike. All pacemaker spikes appear uniform. Do not diagnostically interpret pacemaker spike size and shape.</p> <p>PATIENT HAZARD—A pacemaker pulse can be counted as a QRS during asystole in either pace mode. Keep pacemaker patients under close observation.</p>

PACEMAKER PATIENTS. Rate meters may continue to count the pacemaker rate during occurrences of cardiac arrest or some arrhythmias. Do not rely entirely upon rate meter ALARMS. Keep pacemaker patients under close surveillance.

ARRHYTH : Sets up ON/OFF to indicate detection of diagnosis (Asys, VTAC/VFIB and VTAC).

OFF: Do not perform arrhythmia diagnosis.

LETHAL: Performs the detection of Asys, VTAC/VFIB, and VTAC at the selected lead

FULL: Performs the detection of all 13 arrhythmia.

The Analysis algorithm simultaneously uses leads I, II, III, and the V lead for ECG and arrhythmia analysis.

MAIN MENU	ECG FILTER : MONITOR	PACE : OFF	ARRHYTHM : OFF
PREV MENU		PVC SETTING	ST SETTING
MAIN MENU	ECG FILTER : MONITOR	ARRHYTHM : OFF	> OFF LETHAL FULL
PREV MENU			

ACC VENT

Adult— Accelerated ventricular occurs when six or more ventricular beats are detected with an average heart rate for the ventricular beat between 50 and 100 beats per minute.

0-2 years—Occurs when six or more ventricular beats are detected with an average heart rate for the ventricular beat between 60 and 160 beats per minute.

3-10 years—Occurs when six or more ventricular beats are detected with an average heart rate for the ventricular beat between 60 and 140 beats per minute.

11-13 years—Occurs when six or more ventricular beats are detected with an average heart rate for the ventricular beat between 60 and 130 beats per minute.

ASYSTOLE

Ventricular asystole occurs whenever the displayed heart rate drops to zero.

BIGEMINY

Occurs when two or more bigeminal cycles (a ventricular beat followed by a non-ventricular beat) are detected.

BRADY

Bradycardia is the average of the most recent eight R-to-R intervals at a heart rate less than the set low heart rate limit.

NOTE

The Brady limit matches the low heart rate limit. If the low heart rate limit is changed, the Brady limit changes.

COUPLET

Occurs when two ventricular beats are detected and have non-ventricular beats before and after the couplet. The coupling interval must be less than 600 milliseconds.

IRREGULAR

Occurs when six consecutive normal R-to-R intervals vary by 100 milliseconds or more.

PAUSE

Occurs when the interval between two consecutive beats exceeds three seconds.

PVC

Isolated premature ventricular complexes occur when a premature ventricular beat is Detected and has non-ventricular beats before and after.

R O N T

Occurs when a ventricular complex is detected within the repolarization period of a Non-ventricular beat.

TACHY

Tachycardia is four R-to-R intervals at a heart rate greater than the set high heart rate limit.

NOTE

The Tachy limit matches the high heart rate limit. If the high heart rate limit is changed, the Tachy limit changes.

TRIGEMINY

Occurs when two or more trigeminal cycles (a ventricular beat followed by two non-Ventricular beats) are detected.

V BRADY

Adult—Ventricular bradycardia occurs when a run of three or more ventricular beats is detected with an average heart rate that is less than or equal to 50 beats per minute.

0-2, 3-10, and 11-13 years—Occurs when a run of three or more ventricular beats is detected with an average heart rate that is less than or equal to 60 beats per minute.

VFIB/VTAC

Ventricular fibrillation occurs when the ECG waveform indicates a chaotic ventricular arrhythm.

ST SETTING : ST signal and setting related ST menu.

MAIN MENU	ECG FILTER : MONITOR	PACE : OFF	ARRHYTHM : OFF
PREV MENU		PVC SETTING	ST SETTING

ST ANALYSIS: ON/OFF ST analysis signal.

MAIN MENU	ST ANALYSIS : ON	MEASUREMENT CONDITION	ST ALARM LIMIT
PREV MENU		TEMPLETE SELECT: III	ST ALARM LEVEL

MEASUREMENT CONDITION: ST measurement condition setting

MAIN MENU	ST ANALYSIS : ON	MEASUREMENT CONDITION	ST ALARM LIMIT
PREV MENU		TEMPLETE SELECT: III	ST ALARM LEVEL

ST MEASUREMENT CONDITION			
> RETURN	UNITS	ISO(R-)	ST(R+)
ST	msec	80	108



ST ALARM LIMIT: ST alarm limit range setting

MAIN MENU	ST ANALYSIS : ON	MEASUREMENT CONDITION	ST ALARM LIMIT
PREV MENU		TEMPLETE SELECT: III	ST ALARM LEVEL

ST ALARM LIMIT			
RETURN	UNITS	LOW	HIGH
ST	mm	-4.0	4.0

ST ALARM LEVEL: ALARM LEVEL setting

MAIN MENU	ST ANALYSIS : ON	MEASUREMENT CONDITION	ST ALARM LIMIT
PREV MENU		TEMPLETE SELECT: III	ST ALARM LEVEL

ST ALARM LEVEL	
> RETURN	ST ALARM LEVEL
ST	MEDIUM

TEMPLATE SELECT: Select a Representative Lead of ST LEVEL.

The trace of the selected LEAD shows up at ST Window of POPUP TREND WINDOW

MAIN MENU	ST ANALYSIS : ON	MEASUREMENT CONDITION	ST ALARM LIMIT
PREV MENU		TEMPLATE SELECT: III	ST ALARM LEVEL
MAIN MENU	TEMPLATE SELECT: III	>	I aVL II aVF III V aVR
PREV MENU			

PVC SETTING: PVC ON/OFF and ALARM limit range setting

MAIN MENU	ECG FILTER : MONITOR	PACE : OFF	ARRHYTHM : OFF
PREV MENU		PVC SETTING	ST SETTING

PVC ANALYSIS: Decision maker to display PVC value sign with ON/OFF

MAIN MENU	PVC ANALYSIS : ON		PVC ALARM LIMIT
PREV MENU			PVC ALARM LEVEL

PVC ALARM LIMIT: Set alarm indicate to PVC

MAIN MENU	PVC ANALYSIS : ON		PVC ALARM LIMIT
PREV MENU			PVC ALARM LEVEL

PVC ALARM LIMIT			
RETURN	UNITS	LOW	HIGH
PVC	/mm	0	20

PVC ALARM LEVEL: Set PVC ALARM LEVEL

MAIN MENU	PVC ANALYSIS : ON		PVC ALARM LIMIT
PREV MENU			PVC ALARM LEVEL

PVC ALARM LEVEL	
> RETURN	PVC ALARM LEVEL
PVC	MEDIUM

Warning

Display Hart Beat Equipment Signal

Hart Beat equipment signal displays when the PACE mode is. the signal appears series form. The signal size or form are meaningless clinically

Number Of Heart Beat

Attention to the patient with heart beat equipment. The heart beat equipment can show heart beat even during arrhythmia continuously. Therefore, do not depend on heart beat alarm excessively.

CAUTION

FDA POSTMARKET SAFETY ALERT

The United States FDA Center for Device and Radiological Health issued a safety bulletin October 14, 1998. this bulletin states “that minute ventilation rate-adaptive implantable pacemakers can occasionally interact with certain cardiac monitoring and diagnostic programmed rate.”

The FDA further recommends precautions to take into consideration for patients with these types of pacemakers. These precaution for patients with these types of pacemakers. These precautions include disabling the rate responsive mode and enabling an alternate pace mode. For more information contact:

Office of Surveillance and Biometrics, CDRH, FDA
1350 Packard Drive, Mail Stop HFZ-510 Rockville, MD 20850 U.S.A

NOTE

ECG monitoring with patients in non-invasive trans coetaneous pacemakers may not be possible due to large amounts of energy produced by these devices. Monitoring ECG with an external device may be needed.

WARNINGS

VENTRICULAR ARRHYTHMISAS

The arrhythmia analysis program is intended to detect ventricular arrhythmias. It is not designed to detect a trial or supra ventricular arrhythmias. Occasionally it may incorrect identify the presence or absence of an arrhythmia. Therefore, a physician must analyze the arrhythmia information in conjunction with other clinical findings.

SUSPENDED ANALYSIS

Certain conditions suspend arrhythmia analysis. When suspended, arrhythmia conditions are not detected and alarms associated with arrhythmias do not occur. The messages which alert you to the conditions causing suspended arrhythmia analysis are : ARR OFF, ARRHYSUSPEND, LEADS FAIL, ALARM PAUSE, ALL ALARMS OFF, and DISCHARGED.

Trouble shooting

Problem :

Inaccurate heart rate and/or false a systole.

Solution :

Check ECG signal from patient:

1. Check/adjust lead placement.
2. Check/perform skin preparation.
3. Check/replace electrodes.

Check amplitude of ECG waveform:

1. Select ECG parameter label.
2. Select DISPLAY LEAD,
3. Scroll through all ECG leads and check for 0.5mV amplitude at normal (1X) size. (at least 0.5mV amplitude is required for QRS detection.) for borderline signals, validate on a graph.
4. If amplitudes are low, electrodes may need to be repositioned or replaced.

Problem :

False ventricular calls.

Solution :

Check ECG signal from patient: (the chest lead may exhibit polarity changes which may occasionally cause an inaccurate call.)

1. Check/adjust lead placement.
2. Check/perform skin preparation.
3. Check/replace electrodes. (if chest lead is a problem, move the chest lead to another chest position or leg position.)

Problem :

Inaccurate pacemaker detection

Solution :

Use pacemaker processing:

1. Select ECG parameter label.
2. Display the lead of ECG with the greatest amplitude in the top waveform position.
3. Select ANALYSIS SETTINGS.
4. SELECT DETECT PACE.

6. SpO₂

6.1 Outline

SpO₂ Connector Location and Measuring Cable

6.2 SpO₂ Data Window

6.3 SpO₂ Data Setup

SWEEP SPEED

RATE VOLUME

ALARM

ALARM LIMIT

6.1 Outline

SPO2 monitoring is a noninvasive technique used to measure the amount of oxygenated hemoglobin and pulse rate by measuring the absorption of selected wavelengths of light. The light generated in the probe passes through the tissue and is converted into an electrical signal by the photodetector in the probe. The monitor processes the electrical signal and displays on the screen a waveform and digital values for SpO2 and pulse rate. It detects SpO2 in the way of transmitting the red and infrared rays into the capillary vessel to take the pulsation. Also perform the alarm function according to the setting value.

SpO2 Connector Location and Measuring Cable

SpO₂ connector

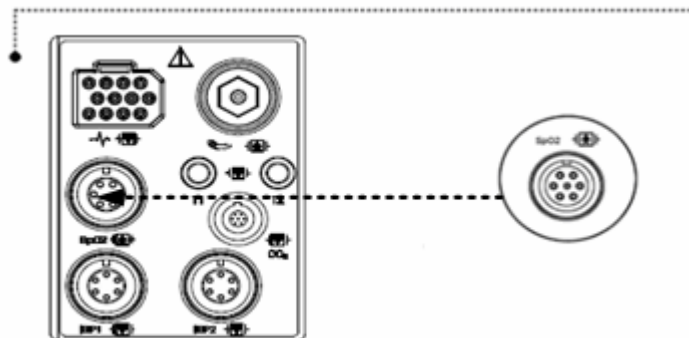

SpO₂ Cable +
Extention Cable



Position of SpO₂ Probe

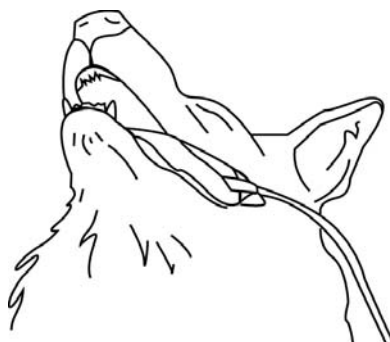

Note

The signal input is a high-insulation port and it is defibrillator proof ()

The insulated input ensures patient safety and protects the device during defibrillation and electro-surgery.

6.2 SpO₂ Data Window

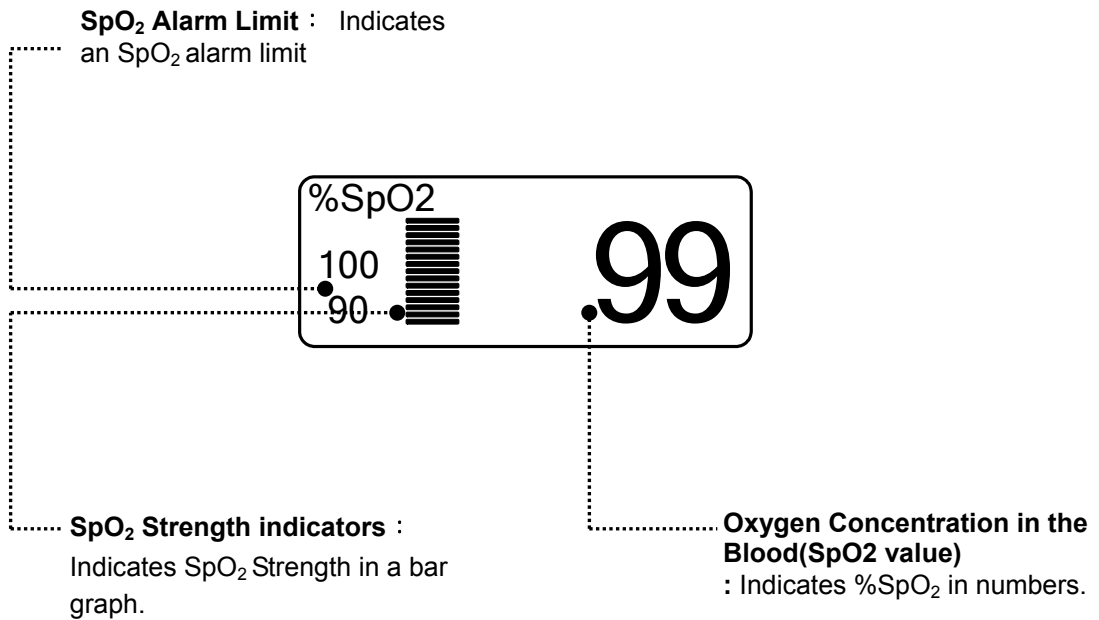

The current SPO2 value and the derived pulse rate (RATE) are displayed. The block sets indicate the strength of the signal (twenty block bars indicate the strongest signal). The SPO2 measurements are averaged over a 6-second period of time.

The monitor display is updated every second.

The SPO2 monitoring features are found in the SPO2 menu. These features include alarm limit adjustment, display of RATE, and RATE volume.

Note

SpO₂ WAVE SIZE is changed automatically.

Signal and Data Validity

It is extremely important to determine that the probe is attached to the patient correctly and the data is verifiable. To make this determination, three indications from the monitor are of assistance—signal strength bar, quality of the SPO₂ waveform, and the stability of the SPO₂ values. It is critical to observe all three indications simultaneously when ascertaining signal and data validity.

Signal Strength Bar

The signal strength bar is displayed within the SPO₂ values window. This bar consists of 20 blocks set depending on the strength of the signal. Proper environmental conditions and probe attachment will help to ensure a strong signal.

Quality of SPO₂ Waveform

Under normal conditions, the SPO₂ waveform corresponds to (but is not proportional to) the arterial pressure waveform. The typical SPO₂ waveform indicates not only a good waveform, but helps the user find a probe placement with the least noise spikes present. The figure below represents an SPO₂ waveform of good quality.

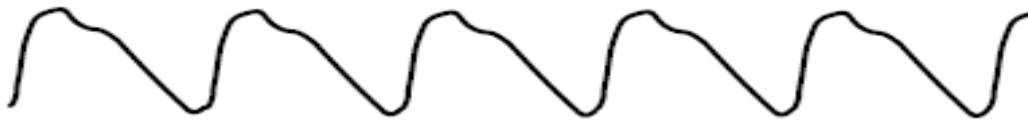

Good Quality SPO₂ Waveform

If noise (artifact) is seen on the waveform because of poor probe placement, the photodetector may not be flush with the tissue. Check that the probe is secured and the tissue sample is not too thick. Pulse rate is determined from the SPO₂ waveform which can be disrupted by a cough or other hemodynamic pressure disturbances. Motion at the probe site is indicated by noise spikes in the normal waveform. (See the figure below.) It has been noted that letting the patient view the SPO₂ waveform enables them to assist in reducing motion artifact.



SPO₂ Waveform with Artifact

Stability of SPO2 Values

The stability of the displayed SPO2 values can also be used as an indication of signal validity. Although stability is a relative term, with a small amount of practice one can get a good feeling for changes that are artifactual or physiological and the speed of each. Messages are provided in the SPO2 values window to aid you in successful SPO2 monitoring.

WARNING

In the monitoring of patients the coincidence of adverse conditions may lead to a disturbed signal going unnoticed. In this situation artifacts are capable of simulating a plausible parameter reading, so that the monitor fails to sound an alarm. In order to ensure reliable patient monitoring, the proper application of the probe and the signal quality must be checked at regular intervals.

6.3 SpO₂ Data Setup

ALARM : Menu in which SpO₂ alarm are set up.

RATE VOLUME : Menu in which RATE VOLUME is set up

MAIN MENU	ALARM		RATE VOLUME: OFF

RATE VOLUME

Move the KEY to select the volume from OFF to 100%.

When the ECG volume rate is set, it turns OFF automatically.

MAIN MENU	ALARM		RATE VOLUME: OFF
MAIN MENU	RATE VOLUME: OFF	>	OFF 60%
			10% 70%
			20% 80%
			30% 90%
			40% 100%
			50%

ALARM

Two menus: ALARM LIMIT, ALARM SOUND provided in the alarm menu

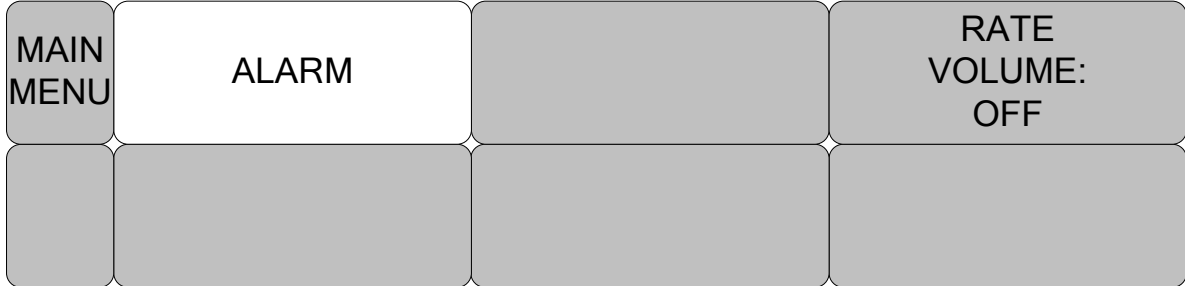

ALARM LIMIT

Number setting of alarm value of %SpO₂ is 0 ~ 100

1. Move the mark to select from RETURN, SpO₂ or SpO₂-R, and press.
2. After pressing at SpO₂, move the cursor right or left to LOW, and press.
3. Once the color is changed, move the cursor again to the selected value and press.
4. Place the cursor to HIGH and press, when the color changes, move the cursor again to select the targeted value, and press. Finally move to SpO₂ and press.
(You may decide to perform the process in the opposite order, LOW to HIGH, to have the same result.)
5. After pressing at SpO₂-R, move the cursor right or left to LOW, and press.
6. Once the color is changed, move the cursor again to the selected value and press.
7. Place the cursor to HIGH and press, when the color changes, move the cursor again to select the targeted value, and press. Finally move to SpO₂-R and press.
8. With the selection of RETURN the user gets out of the menu.

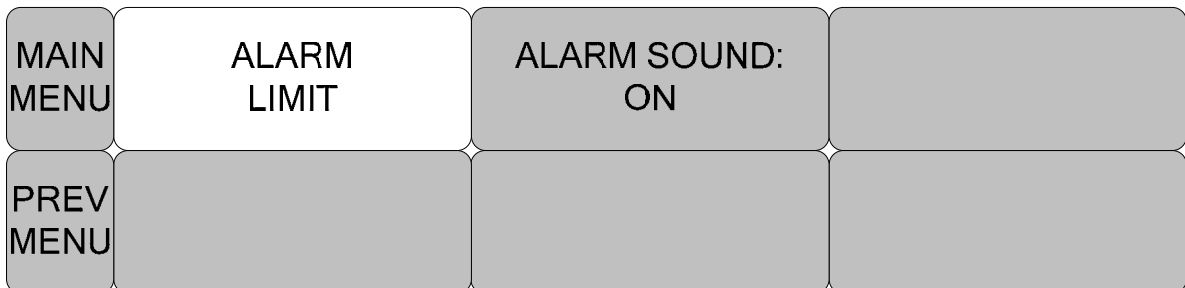

SPO2 ALARM LIMIT			
RETURN	UNITS	LOW	HIGH
SPO2-%	%	90	100
SPO2-R	BPM	50	150

ALARM SOUND

Warning sound or message displays configuration menu when an alarm is triggered.

MAIN MENU	ALARM LIMIT	ALARM SOUND: ON	
PREV MENU			

MAIN MENU	ALARM LIMIT	ALARM SOUND: OFF	
PREV MENU			

LEAD FAULT Condition

When using a reusable finger probe, there is a system alarm to alert you when the probe is off the Monitor. The monitor defaults this " LEAD FAULT" condition as a System Warning alarm. however, You can set it as a System ALARM LEVEL in Monitor Defaults.

SPO2 Messages

Below is a list of system status alarm messages which may be displayed in the SPO2 parameter window during monitoring.

CHECK PROBE

Reusable finger probe is off the patient. Check the probe. *The factory default for this alarm is MESSAGE ALARM.*

PULSE SEARCH

Detection by the monitor of a repeatable pulse has ceased. Check the patient and the probe site.

POOR SIGNAL

The SPO2 signal is too low. No SPO2 data is displayed. This can be due to a low patient pulse, patient motion, or some other interference. Check the patient and the probe.

LOST SIGNAL

SPO2 data continues to be displayed, but the quality of the signal is questionable. Check the patient and the probe.

ARTIFACT

The SPO2 signal is patient's motion artifact and noise

7. RESPIRATION

7.1 Outline

Respiration Connector and Measuring Cable

7.2 RESPIRATION Data Window

7.3 RESPIRATION Data Setup

Respiration Size

Alarm Limit

7.1 Outline

Respiration via ECG Lead II electrode makes the skin area of the chest enlarged, causing changes in the resistance of skin. Through this it calculates respiration value per minute and performs the alarm function according to limit value.

Respiration Connector and Measuring Cable

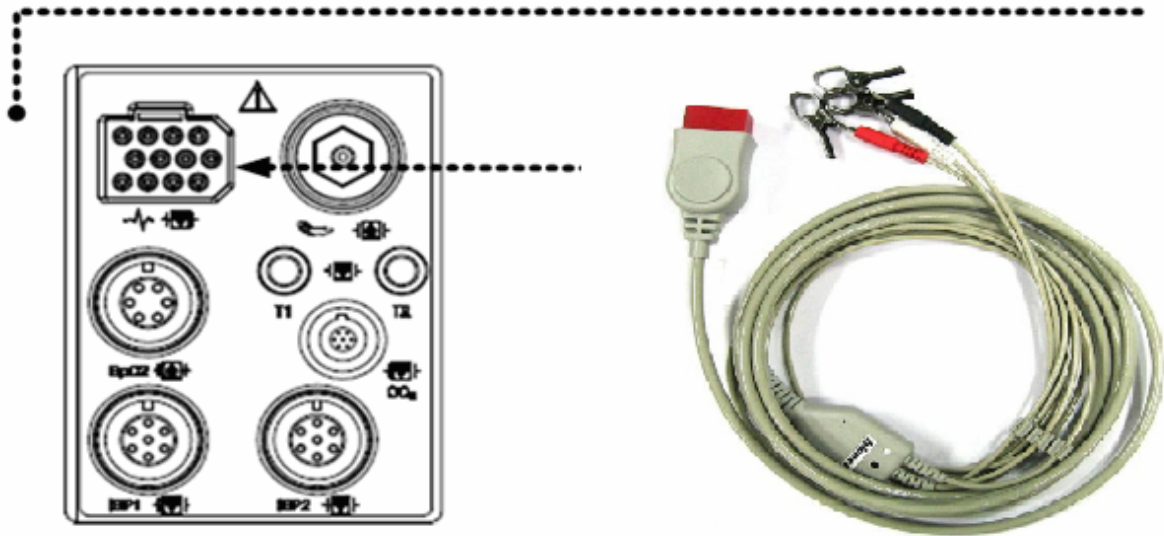

7.2 Respiration Data Window

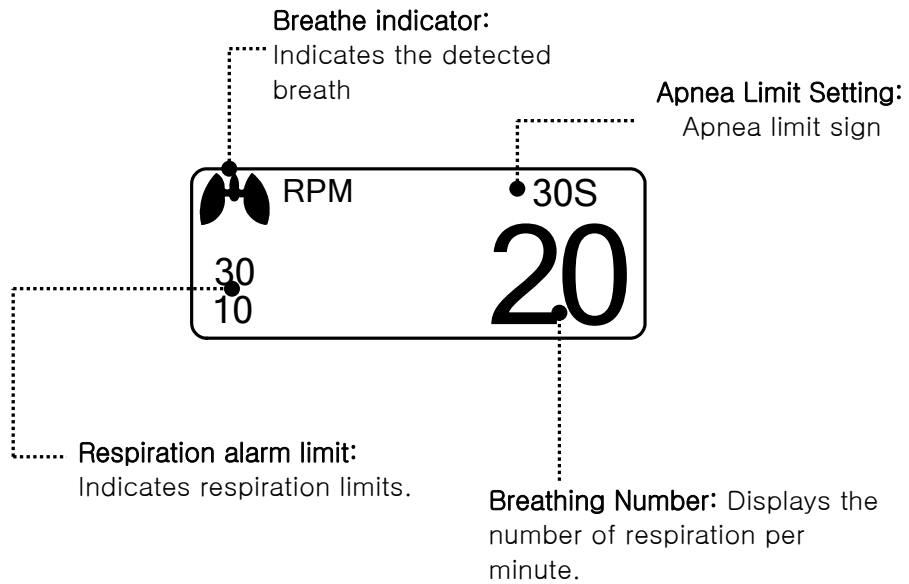

7.3 Respiration Data Setup

ALARM: Respiration alarm setting menu

RESP SIZE: A menu to setup Wave Display

SWEEP SPEED: A menu to setup Wave Display of speed

APNEA DETECT: A menu to setup APNEA alarm display

MAIN MENU	ALARM	SWEEP SPEED : 25mm/s	RESP SIZE : X 2
	APNEA DETECT : ON	LEAD SELECT: II	

RESPIRATION SPEED

Wave pattern speed is 6.25 , 12.5 , 25 mm/s.

MAIN MENU	ALARM	SWEEP SPEED : 12.5mm/s	RESP SIZE : X 2
	APNEA DETECT : ON	LEAD SELECT: II	
MAIN MENU	ALARM	SWEEP SPEED: 12.5mm/s	6.25 mm/s > 12.5 mm/s 25 mm/s
	APNEA DETECT : ON		

RESPIRATION

Set wave pattern size X2~ X10.

MAIN MENU	ALARM	SWEEP SPEED : 12.5mm/s	RESP SIZE : X 2
	APNEA DETECT : ON	LEAD SELECT: II	
MAIN MENU	ALARM	RESP SIZE : X 2	> X 2 X 4 X 6 X 8 X10
	APNEA DETECT : ON		

APNEA DETECT

Deciding function of activating Apnea Alarm

MAIN MENU	ALARM	SWEEP SPEED : 12.5mm/s	RESP SIZE : X 2
	APNEA DETECT : ON	LEAD SELECT: II	
MAIN MENU	ALARM	SWEEP SPEED : 12.5mm/s	RESP SIZE : X 2
	APNEA DETECT : OFF	LEAD SELECT: II	

LEAD SELECT

This is for changing the reference LEAD for respiration

LEAD I or LEAD III can be selected.

MAIN MENU	ALARM	SWEEP SPEED : 25mm/s	RESP SIZE : X 2
	APNEA DETECT : ON	LEAD SELECT: I	
MAIN MENU	ALARM	SWEEP SPEED : 25mm/s	RESP SIZE : X 2
	APNEA DETECT : ON	LEAD SELECT: II	

ALARM

Alarm menu provide ALARM LIMIT and ALARM SOUND .

MAIN MENU	ALARM	SWEEP SPEED : 12.5mm/s	RESP SIZE : X 2
	APNEA DETECT : ON	LEAD SELECT: II	

ALARM LIMIT

Alarm Limit of Respiration Numeric Value is 5 ~ 150bpm

Alarm Limit of RESPIRATION APNEA Numeric Value is 3 ~ 30sec.

MAIN MENU	ALARM LIMIT	ALARM SOUND : ON	
PREV MENU			

1. Move the mark to select RETURN, RESP or RESP-A, and press.
2. After a press in RESP, move the cursor right or left to LOW, and press.
3. After the color changed, move the cursor right or left to the selected value, and press.
4. Place the cursor to HIGH, and press. When the color has changed, move the cursor again to select the value and press. Move to the RESP and press again. (You may decide to perform the process in the opposite order, LOW to HIGH, to have the same result.)
5. Once RESP-A is pressed, move to LOW and press.
6. When the color has changed, move the cursor to select the value, and press.
7. A press in the HIGH position, the color changes. Then move the cursor to select the value and press. Move again to RESP-A, and press.
8. Select RETURN to get out of the window.

RESP ALARM LIMIT			
RETURN	UNITS	LOW	HIGH
RESP	RPM	10	30
RESP-A	SEC	0	20

ALARM SOUND

Warning sound or message displays activation setting when Respiration ALRAM occurs.

MAIN MENU	ALARM LIMIT	ALARM SOUND : ON	
PREV MENU			
MAIN MENU	ALARM LIMIT	ALARM SOUND : OFF	
PREV MENU			

8. NIBP

8.1 Outline

NIBP Connector Location and Cuff

8.2 NIBP Data Window

8.3 NIBP Data Setup

ALARM LIMIT

ALARM

CUFF SIZE

UNIT SELECT

INTERVAL

STAT

INFLATION

8.1 Outline

This function is to measure minimum, Maximum and average blood pressure by using Oscillometric method

Position of NIBP Connector and cuff

NIBP Connector

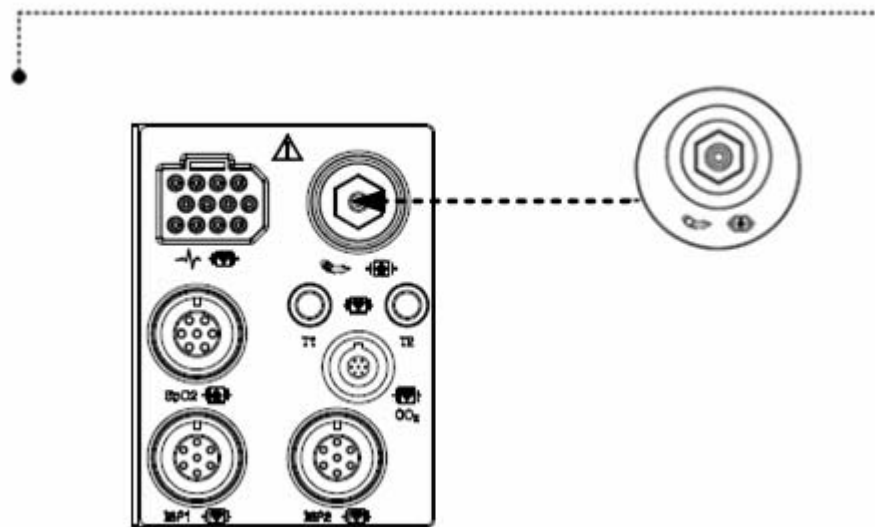

LARGE CUFF



CAT CUFF Placement



DOG CUFF Placement



Note

As the value of NIBP can vary according to the age and sex of a patient, the user needs to set up right data in Parameter Menu before measurement.

WARNING

Noninvasive blood pressure monitoring is not recommended for patients with hypotension, hypertension, arrhythmias or extremely high or low heart rate. The software algorithm cannot accurately compute NIBP or patients with these conditions.

Note

As the value of NIBP can vary according to the age and sex of a animal, the user needs to set up right data in parameter Menu before measurement. Tubes between the cuff and the monitor are not kinked or blocked.

The air pad should be exactly over the branchial artery. Tubing is immediately to the right or left of the branchial artery to prevent kinking when elbow is bent.

The routine maintenance is performed every 2 years.

Check the following list to ensure device operates properly and safety at all times.

1. Check for proper cuff size.
2. Check for residual air left in the cuff from a previous measurement.
3. Make sure cuff is not too tight or too loose.
4. Make sure cuff and heart are at same level, otherwise hydrostatic pressure will offset the NIBP value.
5. Minimize animal movement during measurement.
6. Check for leak in cuff or tubing.
7. Animal may have a weak pulse.

8.2 NIBP Data Window

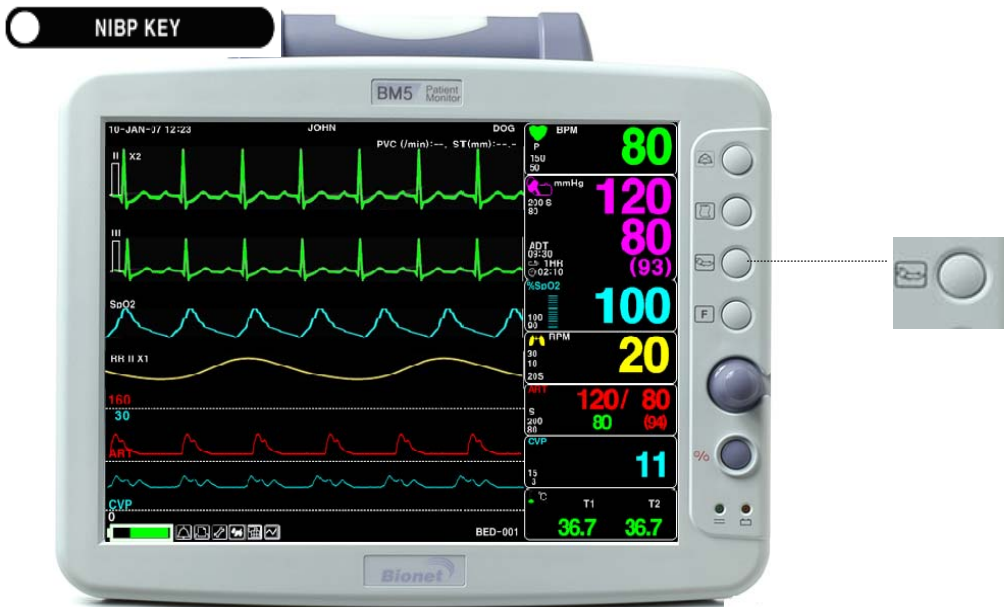
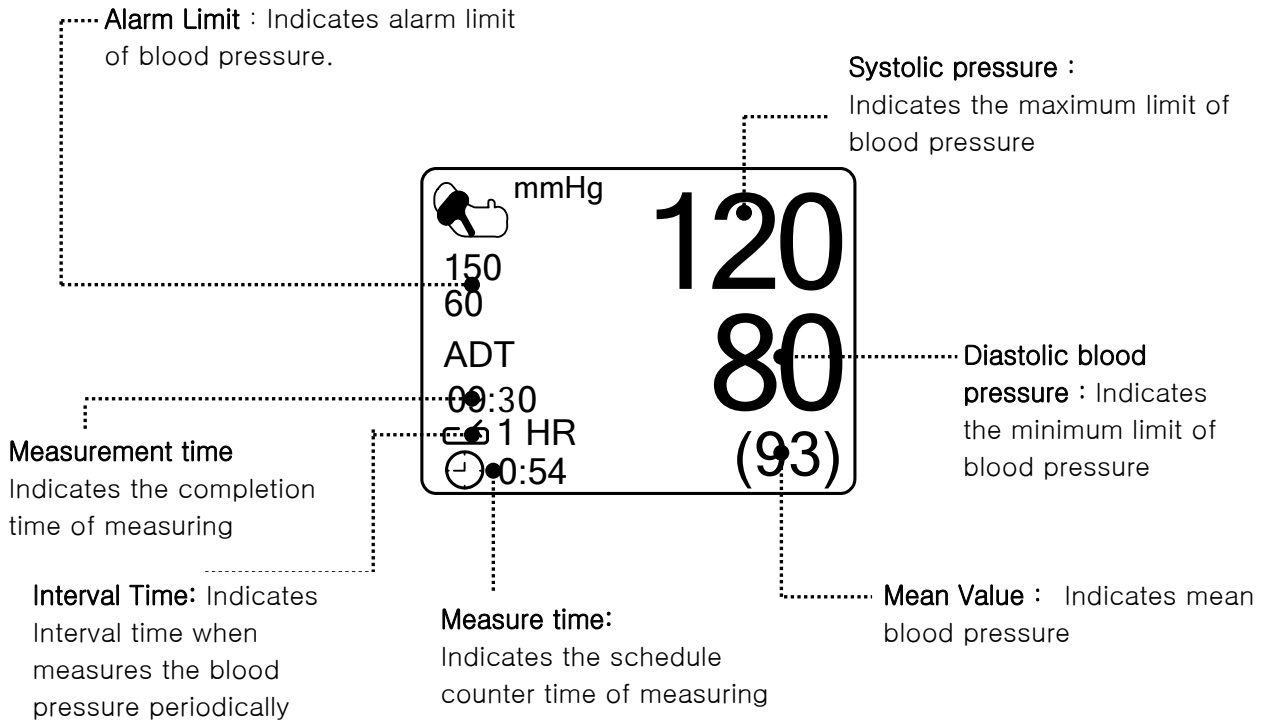

POWER OFF

When power is cut off during pressure, air runs out of the CUFF automatically.

8.3 NIBP Data Setup

ALARM : A menu to set the Alarm

CUFF SIZE : A menu to select cuff size

UNIT SELECT: A menu to select the pressure unit

INTERVAL : A menu to set Interval time when measures the blood pressure periodically

INFLATION: Initial Pressurization setting menu

MAIN MENU	ALARM		CUFF SIZE: MEDIUM
	UNIT SELECT: mmHg	INFLATION: 170mmHg	INTERVAL: OFF

ALARM

The alarm provides ALARM LIMIT and ALARM SOUND.

MAIN MENU	ALARM		CUFF SIZE: MEDIUM
	UNIT SELECT: mmHg	INFLATION: 170mmHg	INTERVAL: OFF
MAIN MENU	ALARM LIMIT	ALARM SOUND: ON	
PREV MENU			

ALARM LIMIT

Alarm setting Numeric Value of Systolic, Diastolic, and mean pressure is 10 ~ 360mmHg.

1. Move the mark to select one from RETURN, NIBP-S, NIBP-M, or NIBP-D, and press.

2. Press the key at NIBP-S, and move to LOW, and press again. (The user gets the same result regardless of the LOW-HIGH, or HIGH-LOW order.)
3. When the color has changed, move it again to select a target value, and press.
4. Press the key at HIGH. When the color has changed, move to the right to select a target value, and press.
5. Set up or revise the values of NIBP-M and NIBP in the same way as above.
6. With the selection of RETURN, the user can get out of the window.

MAIN MENU	ALARM LIMIT	ALARM SOUND: ON	
PREV MENU			

NIBP ALARM LIMIT			
RETURN	UNITS	LOW	HIGH
NIBP-S	mmHg	80	200
NIBP-M	mmHg	40	140
NIBP-D	mmHg	20	120

ALARM SOUND

The menu which decide activate of warning sign and message display when the respiration alarm is on.

MAIN MENU	ALARM LIMIT	ALARM SOUND: ON	
PREV MENU			

CUFF SIZE

The user can select a CUF between ADULT and NEONATAL.

MAIN MENU	ALARM		CUFF SIZE: MEDIUM
	UNIT SELECT: mmHg	INFLATION: 170mmHg	INTERVAL: OFF

MAIN MENU	ALARM	CUFF SIZE:	LARGE MEDIUM SMALL
	UNIT SELECT: mmHg		

UNIT SELECT

It is a function to set blood pressure measurement unit.

The blood pressure measurement unit provides mmHg and kPa.

MAIN MENU	ALARM		CUFF SIZE: MEDIUM
	UNIT SELECT: mmHg	INFLATION: 170mmHg	INTERVAL: OFF
MAIN MENU	ALARM		CUFF SIZE: MEDIUM
	UNIT SELECT: kPa	INFLATION: 170mmHg	INTERVAL: OFF

INTERVAL

This menu is used for selecting intervals when measures the blood pressure automatically.

Select a target interval from 1min, 2, 3, 4, 5, 10, 15, 20, 30, 1hour, 2, 4, 8.

MAIN MENU	ALARM		CUFF SIZE: MEDIUM
	UNIT SELECT: mmHg	INFLATION: 170mmHg	INTERVAL: OFF
MAIN MENU	INTERVAL: OFF	> OFF	15MINS
		1MIN	20MINS
		2MINS	30MINS
		3MINS	1HR
		4MINS	2HRS
		5MINS	4HRS
		10MINS	8HRS

INFLATION

It is a function for pressurization pressure.

ADT/PED : Numeric value is 80, 90, 100, 110, ~ 230, and 240.

Numeric value is 60, 70, 80, 90, 100, 110, and 120.

MAIN MENU	ALARM		CUFF SIZE: MEDIUM
	UNIT SELECT: mmHg	INFLATION: 170mmHg	INTERVAL: OFF
MAIN MENU	ALARM		CUFF SIZE: MEDIUM
	UNIT SELECT: mmHg	INFLATION: 80mmHg	INTERVAL: OFF
MAIN MENU	ALARM		CUFF SIZE: MEDIUM
	UNIT SELECT: mmHg	INFLATION: 240mmHg	INTERVAL: OFF

Warning

Pay attention to not to block connecting hose when you put cuff on patient.

9. IBP

9.1 Description

IBP Connectors & Accessories

9.2 IBP Data Window

9.3 IBP Data Setting

CHANGE NAME (Configuration of measuring position)

SCALE (Configuring size of measurement waveform)

ALARM LIMITS (Maximum / Minimum Alarming Values)

SETTINGS (Various Settings)

ZERO (Zero-Point Setting)

9.1 Description

IBP has an alarming function based on the maximum & minimum alarming values configured by measuring the systolic, diastolic and mean blood pressure values with signal processing of electric signals which are transformed from changes in impedance components according to the changes of blood flow in vessels.

IBP Connectors & Accessories

IBP connector

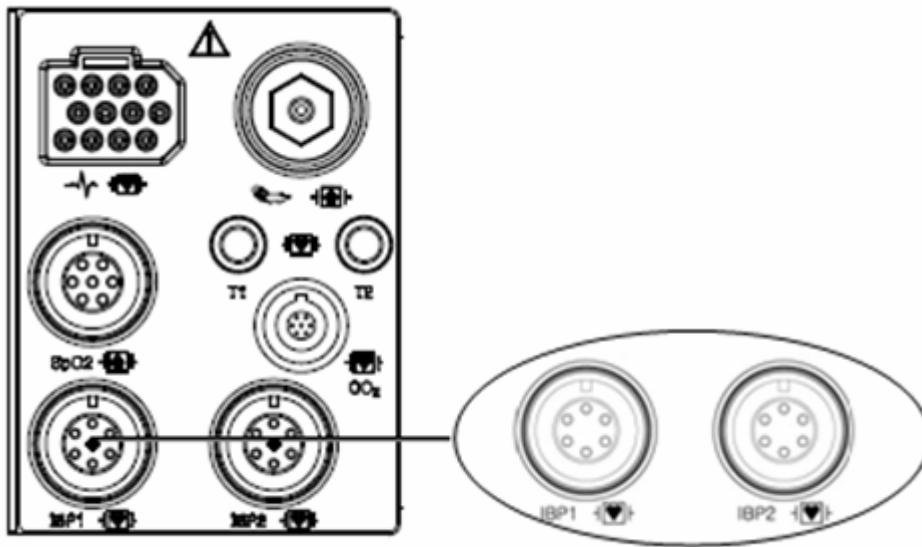

IBP ACCESSARY

MEDEX Kit is used for IBP MONITORING KIT.

LogiCal Disposable Pressure Transducers Cartridges and Monitoring kit

MX9604A LogiCal® 60" (152cm) single line monitoring kit.

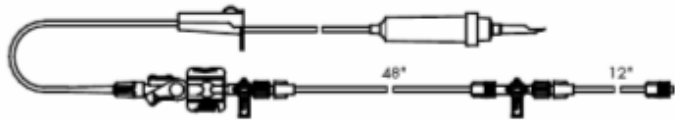

MX9602A LogiCal® double line monitoring kit.

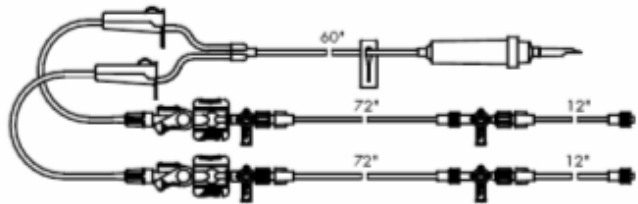

MX960 LogiCal® transducer mounting plate.

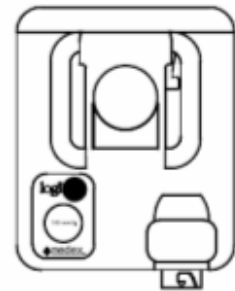

MX261 LogiCal® clamp for transducer bracket.

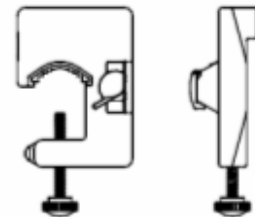

TranStar Disposable Pressure Transducers Cartridges and Monitoring kit

MX9504T

TranStar® 60" single line monitoring kit.

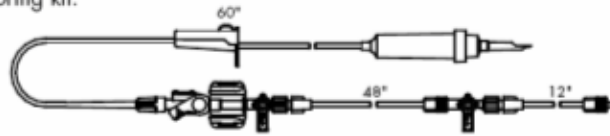

MX800

Modular transducer mounting plate.

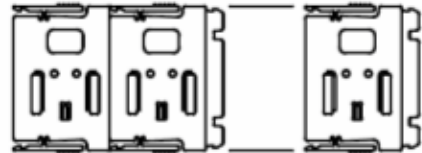

MX240

Pole clamp for mounting a transducer plate (fits 3/4" to 1-1/2" I.V. pole).



MX4810

C-Fuser® 1000ml Pressure Infusor complete unit with squeeze bulb and pressure gauge.

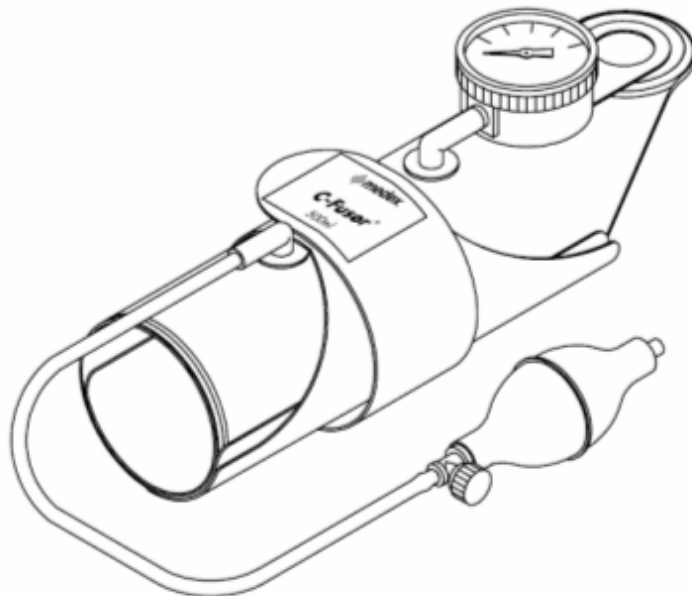

9.2 IBP Data Window

Different data windows are displayed on the screen according to the measuring positions.

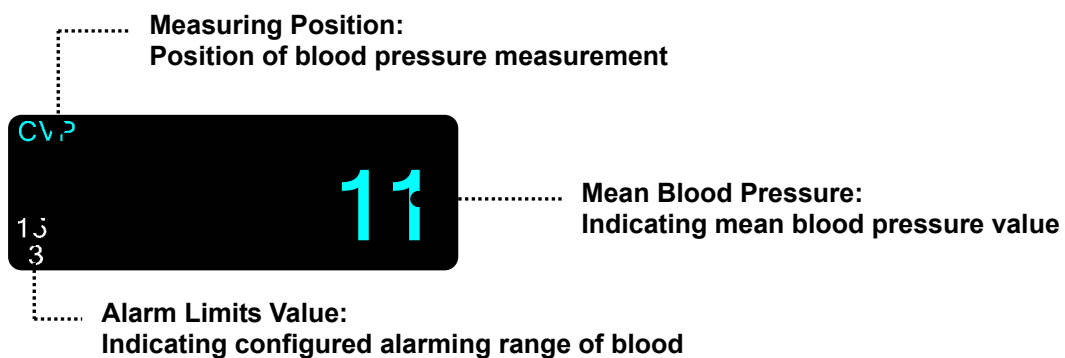
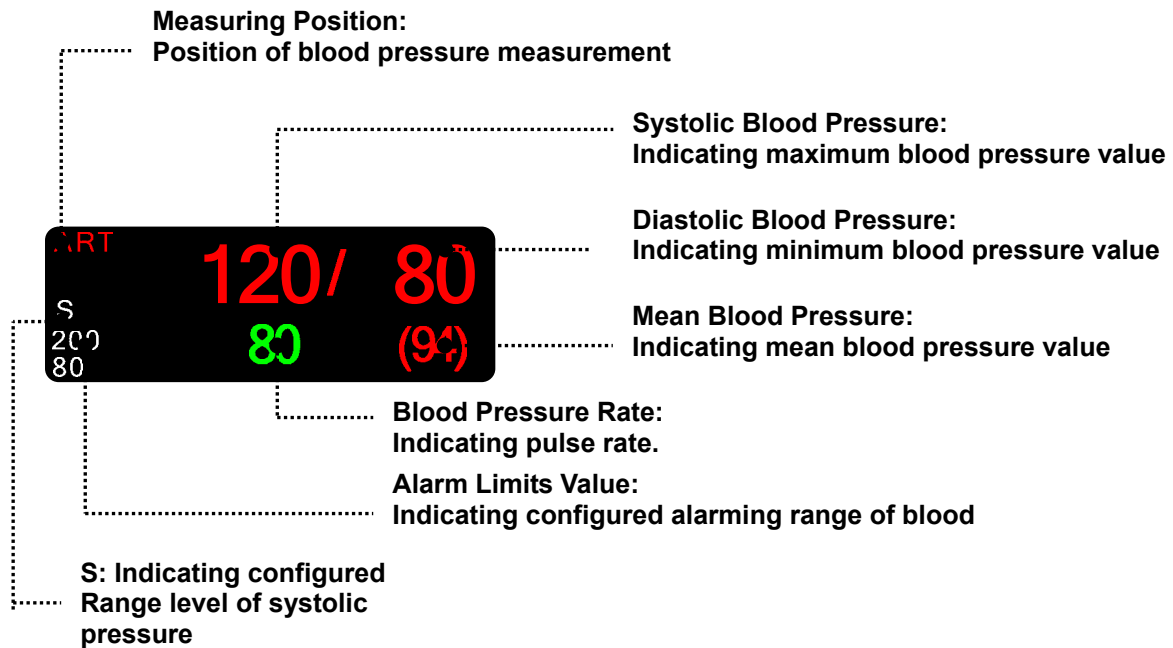

9.3 IBP Data Setting

Labels for measuring positions are described on each menu.

CHANGE NAME: Menu to set measuring position

SCALE: Menu to set size of measurement waveform on screen.

LIMITS: Menu to set alarming range.

SETTING: Menu for processing various pressure signals.

ZERO: Menu to set zero-point of Transducer.

UNIT SELECT : Menu to unit change.

MAIN MENU	CHANGE NAME :ART	ART SCALE: 160	ALARM LIMIT
	SETTINGS ART	UNIT SELECT: mmHg	ZERO :ART

CHANGE NAME (Setting Measuring Position)

It performs the name changing function for a measuring position to monitor.

The setting positions are **ART, FEM, PAP, RAP, LAP, UAP, UVP, CVP, ICP** and **OTHER**.

MAIN MENU	CHANGE NAME :ART	ART SCALE: 160	ALARM LIMIT
	SETTINGS ART	UNIT SELECT: mmHg	ZERO :ART
MAIN MENU	CHANGE NAME :ART	> ART FEM PAP RAP LAP	UAP UVP CVP ICP BP1

List & Description of IBP Measurement Parameter Label

Parameter Window, Scales Menu Window or Alarm Limits Pop-up Menu will appear according to the Labels.

IBP displays the measuring positions based on 10 labels shown in the below table.

The below table shows the names for each label and the descriptions to be displayed on the **Parameter Window**.

Select '**OTHER**' for a measuring position not in the listed positions.

LABEL	DESCRIPTION	DISPLAY VALUE
ART	Arterial Pressure	- Systolic, Diastolic and Mean
FEM	Femoral Pressure	- Systolic, Diastolic and Mean
PAP	Pulmonary Artery Pressure	- Systolic, Diastolic and Mean
CVP	Central Venous Pressure	- Mean
LAP	Left Arterial Pressure	- Mean
RAP	Right Arterial Pressure	- Mean
ICP	Intracranial Pressure	- Mean
OTHER	Other (IBP1, IBP2)	- Mean
UAP	Umbilical Artery Pressure	- Systolic, Diastolic, and Mean
UVP	Umbilical Venous Pressure	- Mean

SCALE (Setting size of measurement waveform)

You can set the pressure range for measurement waveform on this menu.

The selectable values mean the maximum blood pressure range value that can be shown in a waveform.

MAIN MENU	CHANGE NAME :ART	ART SCALE: 160	ALARM LIMIT
	SETTINGS ART	UNIT SELECT: mmHg	ZERO :ART

MAIN MENU	ART SCALE: 160	300	30
		200 > 160 100 80	

Alarming Limits for ART

Alarming limits vary according to measuring positions.

The settable alarming range for systolic pressure, diastolic pressure and mean pressure is - 50 ~ 350mmHg.

IBP ALARM LIMIT			
RETURN	UNITS	LOW	HIGH
IBP1-S	mmHg	70	150
IBP1-M	mmHg	50	115
IBP1-D	mmHg	40	100
IBP1-PR	BPM	50	150

MAIN MENU	CHANGE NAME :ART	ART SCALE: 160	ALARM LIMIT
	SETTINGS ART	UNIT SELECT: mmHg	ZERO :ART

The below table shows the settable values of standard alarm limits and scales of parameters for label setting.

Parameter	Adult			Neonatal		
	Low	High	Scale	Low	High	Scale
ART-S	70	150	160	40	100	100
ART-D	40	100		20	50	
ART-M	50	115		30	70	
ART-PR	50	150		50	170	
FEM-S	70	150	160	40	100	100
FEM-D	40	100		20	50	
FEM-M	50	115		30	70	
FEM-PR	50	150		50	170	
UAP-S	70	150	160	40	100	100
UAP-D	40	100		20	50	
UAP-M	50	115		30	70	
UAP-PR	50	150		50	170	
PAP-S	20	50	60	40	100	60
PAP-D	5	30		20	50	
PAP-M	10	40		30	70	
PAP-PR	50	150		50	170	
CVP-S	0	300	30	0	300	30
CVP-D	3	15		3	15	
CVP-M	0	300		0	300	
CVP-PR	50	150		50	170	
RAP-S	0	300	30	0	300	30
RAP-D	3	15		3	15	
RAP-M	0	300		0	300	
RAP-PR	50	150		50	170	
LAP-S	0	300	30	0	300	30
LAP-D	3	15		3	15	
LAP-M	0	300		0	300	
LAP-PR	50	150		50	170	
UVP-S	0	300	30	0	300	30
UVP-D	3	15		3	15	
UVP-M	0	300		0	300	
UVP-PR	50	150		50	170	
ICP-S	0	300	30	0	300	30
ICP-D	3	15		3	15	
ICP-M	0	300		0	300	
ICP-PR	50	150		50	170	
BP1(BP2)-S	0	300	30	0	300	30
BP1(BP2)-D	3	15		3	15	

BP1(BP2)-M	0	300		0	300	
BP1(BP2)-PR	50	150		50	170	

IBP SETTING (Setting Various Functions)

Other menus are to be applied for special functions to process pressure signals in various ways.

MAIN MENU	CHANGE NAME :CVP	ART SCALE: 160	ALARM LIMIT
	SETTINGS CVP	UNIT SELECT: mmHg	ZERO :CVP

Setting three labels of ART, FEM and UAP displaying PULSE-RATE among labels, the functions of PULSE-RATE DISPLAY and DISCONNECT ALARM will be added.

MAIN MENU	BP FILTER: OFF	PULSE RATE: OFF	
PREV MENU	DISCONN. ALARM: OFF		

BP FILTER: It filters waveforms by selecting three frequency bands.

- OFF** **0Hz ~ 40Hz**
- 12Hz** **0Hz ~ 12Hz** Generally recommended for monitoring
- 20Hz** **0Hz ~ 20Hz** Used for processing waveform components of higher frequency. Pressure value can be increased with this filter.

MAIN MENU	BP FILTER: OFF	PULSE RATE: OFF	
PREV MENU	DISCONN. ALARM: OFF		

MAIN MENU	BP FILTER: OFF	> OFF	
PREV MENU		12 Hz 20Hz	

PULSE RATE: Setting display of blood pressure pulse rate.

MAIN MENU	BP FILTER: OFF	PULSE RATE: OFF	
PREV MENU	DISCONN. ALARM: OFF		
MAIN MENU	BP FILTER: OFF	PULSE RATE: ON	
PREV MENU	DISCONN. ALARM: OFF		

CAL. TRANSDUC: A function to adjust a Transducer error on the monitor.

A function to adjust an error value based on the other index manometer.

How to Adjust

1. Select a menu by pressing the knob switch key.
2. Measure blood pressure along with another index manometer.

3. Compare the measured values of 'mmHg' for both manometers.
4. Adjust the error value on the parameter menu screen by turning knob switch.
5. Terminate the menu by pressing the knob switch key again.

DISCONN ALARM: (Alarming function for disconnection)

DISCONN ALARM MENU will be displayed when measurement label is set for ART, FEM and UAP.

This function will be activated upon the following two conditions.

1. In case MEAN PRESSURE is not higher than 25mmHg.
2. In case the Disconnect Alarm is set 'ON'.

Medium alarming sound will be generated when the **DISSCONNECTED ALARM** is activated, and the alarming message "DISCONNECTED" will be displayed on the parameter screen.

MAIN MENU	BP FILTER: OFF	PULSE RATE: OFF	
PREV MENU	DISCONN. ALARM: OFF		
MAIN MENU	BP FILTER: OFF	PULSE RATE: OFF	
PREV MENU	DISCONN. ALARM: ON		



Troubleshootings for a case the measured value is different from the expected value

Description	Action to Take
In case there are air bubbles in tubes	Remove the air bubbles
In case an extension tube is connected	Remove the extension tube

In case of using blood pressure transducer with a different sensitivity	Check position of transducer
For other cases	Perform zero-point adjustment

ZERO ART: (Zero-point Adjustment)

Use ZERO option to set the zero-point of Transducer.

MAIN MENU	CHANGE NAME :ART	ART SCALE: 160	ALARM LIMIT
	SETTINGS ART	UNIT SELECT: mmHg	ZERO :ART

Procedures (Zero reference)

- 1) Close the transducer stopcock on the patient's side.
- 2) Open the venting stopcock on the air side.
- 3) Press the knob switch on the monitor panel.
- 4) Draw a line with the current input data in IBP area of WAVE WINDOW according to the Wave Base Line. And accord the wave line with the data.
- 5) Set the data as '0' on the parameter screen.
- 6) Check if Zero reference is carried out. (Check the pressure parameter on the message window.)
- 7) Close the venting stopcock on the air side.
- 8) Open the transducer stopcock on the patient side. The pressure value should be displayed on the pressure parameter screen in a few seconds.

Troubleshootings for a case that blood pressure value is not displayed on screen

Description	Action to Take
In case of 'out of measurement range' situation	Check the measurement conditions.
In case blood pressure transducer is damaged	Replace the damaged transducer with new one

Warning

All parts, except Transducer, should not be conductive. Otherwise discharge energy may induce a shock to operators during cardioversion.

Note

- Check if there is a scratch on the catheter balloon before using.
- Do not reuse disposal parts and accessories.
- Do not use Saline packs with passed expiration dates.
- Do not use pressure measurement kits in torn packages.
- Remove all air in the saline pack by squeezing it. Otherwise it may cause errors in blood pressure band and may go into the blood vessels.

10. EtCO₂

10.1 INTRODUCTION

Position of EtCO₂ Connector and Accessory

EtCO₂ ACCESSORY

10.2 EtCO₂ Parameter Window

10.3 EtCO₂ Parameter Setting Menu

10.1 Introduction

ETCO₂(End-Tidal CO₂) is a device to see the concentration of end-tidal carbon dioxide, which uses a method of measurement based on the non-dispersed IR absorption of CO₂ using IR ray by sampling a certain part of respiration through pipe during respiration.

EtCO₂ connector position and accessory (Sidestream, Respiration)

EtCO₂ Connector

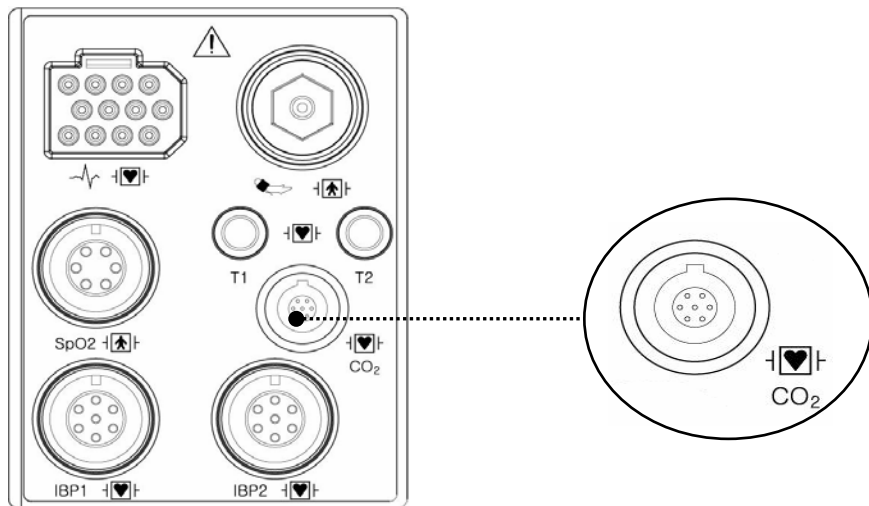

LoFlo sidestream CO₂ sensor and connector





Sidestream sensor



Sidestream sensor connector

EtCO₂ accessories for sidestream applications

EtCO₂ monitoring accessory uses the accessories for LoFlo™ sidestream module of Respironics Company.

The airway adapters for sidestream intubated applications			
3473ADU-00		Airway Adapter Kit w/ Dehumidification Tubing	Dog/Horse Weight: 4.5 grams Deadspace – adds approximately 7 cc of deadspace Intended for use when monitoring patients with ET Tube sizes >4.0 mm
3473INF-00		Airway Adapter Kit w/ Dehumidification Tubing	Cat/Puppy Weight: 5.8 grams Deadspace – adds approximately 1 cc of deadspace Intended for use when monitoring patients with ET Tube sizes <=4.0 mm

Connecting the LoFlo Sample Kit

1. The sample cell of the sampling kit must be inserted into the sample cell receptacle of the LoFlo CO₂ Module as shown in Figure 1. A “click” will be heard when the sample cell is properly inserted.

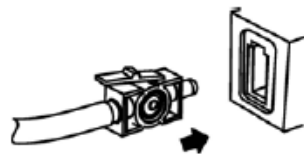

Figure 1

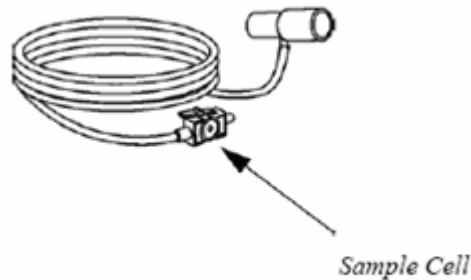

Figure 2

2. Inserting the sample cell into the receptacle automatically starts the sampling pump.

Removal of the sample cell turns the sample pump off.

3. To remove the sampling kit sample cell from the sample cell receptacle, press down on the locking tab and pull the sample cell from the sample cell receptacle.

EtCO2 connector position and accessory (Mainstream, Respirationics)

EtCO2 Connector

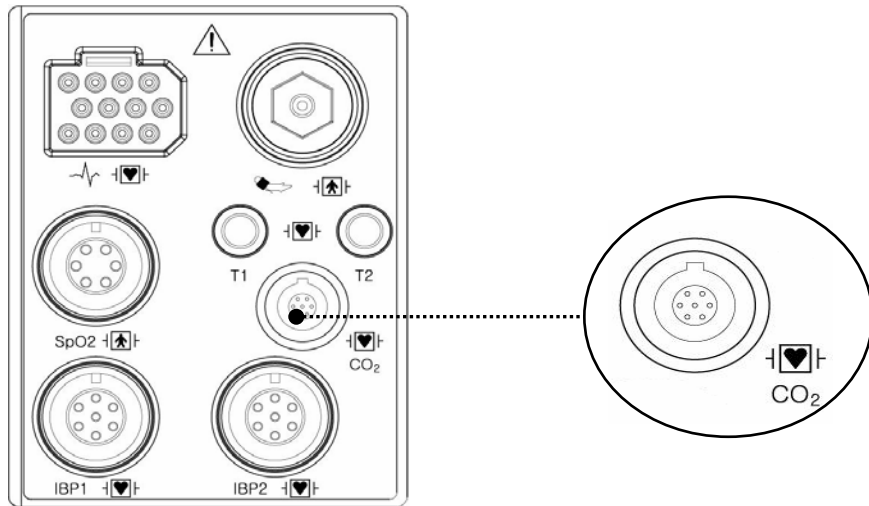

CAPNOSTAT 5 mainstream CO2 sensor and connector





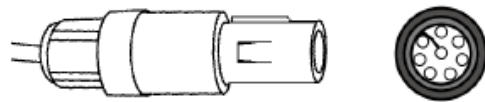

Mainstream sensor



Mainstream sensor connector

EtCO2 accessories for mainstream applications

EtCO2 monitoring accessory uses the accessories for CapnoStat 5 microstream sensor of Respirationics Company.

The airway adapters for mainstream intubated applications		
6063-00		Single-Patient Use Horse Airway Adapter
6312-00		Single-Patient Use Cat and Puppy Airway Adapter
7007-00		Reusable Horse and Dog Airway Adapter
7053-00		Reusable Cat and Puppy Airway Adapter

Connecting the CAPNOSTAT® 5 CO2 Sensor to the Host System

1. Insert the CAPNOSTAT 5 CO2 Sensor connector into the receptacle of the host monitor as shown in Figure 1.

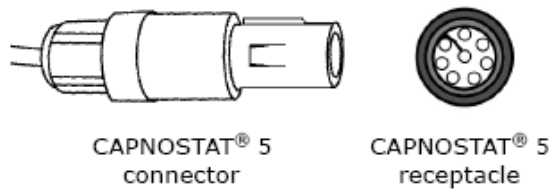

Figure 1

2. Make sure the arrows on the connector are at the top of the connector and line up the two keys of the connector with the receptacle and insert.

3. To remove the connector, grasp the body portion of the connector back and remove.

Note: Do not remove by pulling cable.

Shown below is the CAPNOSTAT 5 CO2 Sensor connection to a Respironics Novamatrix CO2 adapter

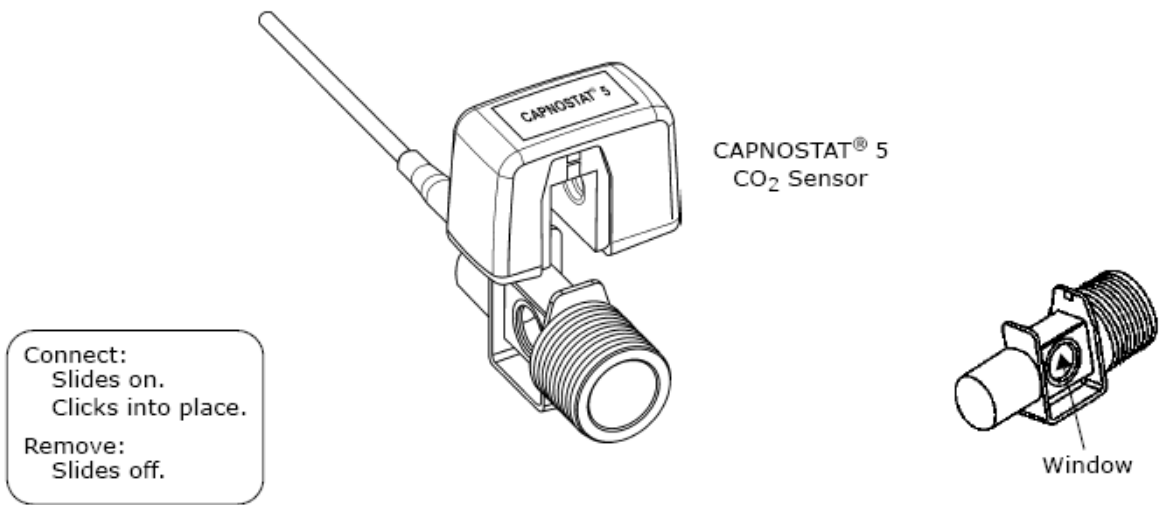

Shown below is the CAPNOSTAT 5 CO₂ Sensor with a patient circuit:

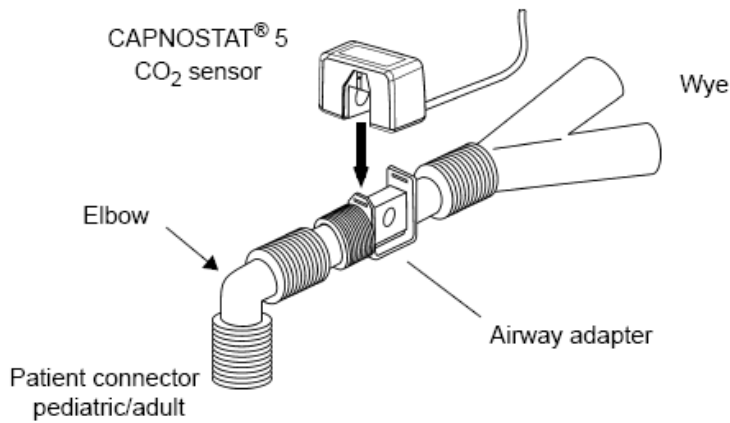

10.2 EtCO₂ Parameter Window

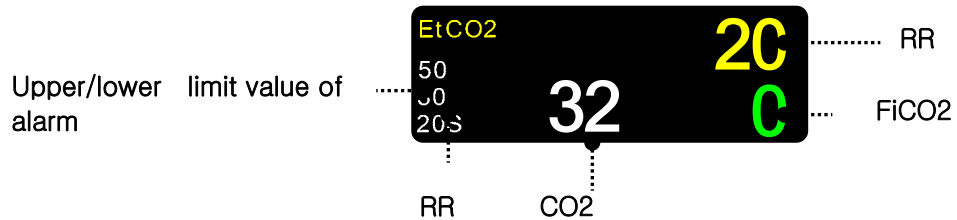

S: Display of apnea setting time in second unit

Upper/lower limit value of alarm: Display of alarm setting range value for concentration of CO₂

EtCO₂: Display of concentration value of carbon dioxide

RR: Display of the number of respirations per minute

FiCO₂: Display of concentration value of carbon dioxide during inspiration

Note

EtCO₂ waveform is always displayed if cable is connected.

10.3 EtCO2 Parameter Setting Menu

ALARM LIMITS: A menu to set the alarm limit

STANDBY: A menu to set the power saving status of EtCO2 module

SCALE: A menu to set the screen scale of measured waveform

SETTINGS: A menu to handle the information of EtCO2 signal

MAIN MENU	ALARM	SWEEP SPEED: 6.25mm/s	WAVEFORM SCALE: 40mmHg
	APNEA DETECT: OFF	SETTINGS	

ART LIMIT(Upper/lower limit value of alarm)

Upper/lower limit value of alarm differs depending on the position of measurement.

The basic setting range of alarm setting value for EtCO2, FiCO2, RR, APNEA.

MAIN MENU	ALARM	SWEEP SPEED: 6.25mm/s	WAVEFORM SCALE: 40mmHg
	APNEA DETECT: OFF	SETTINGS	
MAIN MENU	ALARM LIMIT	ALARM SOUND: OFF	
PREV MENU			

EtCO2 ALARM LIMIT			
RETURN	UNITS	LOW	HIGH
EtCO2	mmHg	25	50
FiCO2	mmHg	0	5
AWRR	RPM	10	30
APNEA	SEC	0	20

The following table shows standard alarm limit of parameter and setting value of scale when setting the label.

Parameter	Adult			Neonatal		
	Low	High	Scale	Low	High	Scale
EtCO2	0	98	40	0	98	40
FiCO2	0	20		0	20	
AWRR	0	100		0	100	
APNEA	0	40		0	40	

EtCO2 SWEEP SPEED

EtCO2 speed is 6.5mm/s.

Speed is changeable to 6.25, 12.5, 25mm/s.

MAIN MENU	ALARM	SWEEP SPEED: 6.25mm/s	WAVEFORM SCALE: 40mmHg
	APNEA DETECT: OFF	SETTINGS	

MAIN MENU	ALARM	SWEEP SPEED: 6.25mm/s	> 6.25mm/s 12.5mm/s 25mm/s
	APNEA DETECT: OFF		

WAVEFORM SCALE (Measured waveform scale setting)

This sets the range of measured waveform versus pressure.

Selectable numerical value means the maximum pressure range value that is shown with waveform.

Pressing the knob switch key and then selecting the desired range value displays the selected pressure range value below the upper dotted line among two dotted lines in the left middle of wave window.

MAIN MENU	ALARM	SWEEP SPEED: 6.25mm/s	WAVEFORM SCALE: 40mmHg
	APNEA DETECT: OFF	SETTINGS	
MAIN MENU	ALARM	WAVEFORM SCALE: 40mmHg	> 40mmHg 50mmHg 60mmHg 80mmHg 100mmHg
	APNEA DETECT: OFF		

SETTINGS (Various setting)

Different menus are applied to provide menu and information for handling the EtCO2 module.

MAIN MENU	ALARM	SWEEP SPEED: 6.25mm/s	WAVEFORM SCALE: 40mmHg
	APNEA DETECT: OFF	SETTINGS	

MAIN MENU	MODULE SETUP	MODULE INFO	
PREV MENU			

MODULE INFO SET	
RETURN	CONTENTS
BAROMETRIC PRESSURE	760 mmHg
GAS TEMPERATURE	0.0 °C
NO BREATH DETECT TIMEOUT	0 SEC
O2 COMPENSATION	21 %
ANESTHETIC AGENT	0.0 %
BALANCE GAS	ROOM AIR
CURRENT ETCO2 TIME PERIOD	0000-00-00-00
CURRENT CO2 UNIT	mmHg
SLEEP MODE	NORMAL OP
ZERO GAS TYPE	ZERO ON N2
DISABLE SAMPLING PUMP	NORMAL OP

- BAROMETRIC PRESSURE: This setting is used to set current Barometric Pressure.
- GAS TEMPERATURE: This setting is used to set temperature of the gas mixture. This setting is useful when bench testing using static gasses where the temperature is often room temperature or below.
- NO BREATH DETECT TIMEOUT: This setting is used to set the no breaths detected time-out. This time-out is the time period in seconds following the last detected breath at which the Capnostat will signal no breaths detected.
- O2 COMPENSATION
ANESTHETIC AGENT
BALANCE GAS: Use this setting to correct for the compensation of the gas mixture administered to the patient. Anesthetic agent is ignored when the balance gas is set to helium.
- CURRENT ETCO2 TIME PERIOD: This setting is used to set the calculation period of the ETCO₂ value. The end-tidal CO₂ value is the highest peak CO₂ value of all end of expirations (end of breaths) over the selected time period. If less than two breaths exist in the selected time period, the value will be the maximum ETCO₂ value for the last two

breaths.

- CURRENT CO2 UNIT: Continuous waveform mode commands (the CO₂ Waveform Mode command [command 80h] and the CO₂/O₂ Waveform Mode command [command 90h]) MUST NOT be active when this command is used otherwise this command will be ignored and the setting will remain unchanged.
- SLEEP MODE: Sleep mode is used to save power when the host monitor is in standby mode. There are two sleep modes available for the Capnostat. Using Sleep Mode 1 maintains the heaters so the Capnostat is able to run immediately after exiting the sleep mode. Mode 2 will require the Capnostat to go through its warm up sequence when exiting this mode and a delay will be introduced until the system has stabilized.
- ZERO GAS TYPE: When performing a zero on room air, this setting should be set to room air (the default). Only change to nitrogen (N₂) when performing a zero on 100% N₂ gas; this is provided for use in a laboratory environment.
- DISABLE SAMPLING PUMP: This setting allows the pump to be forced off. In Normal Operating Mode, the pump will be turned on when the sampling cell is connected and no pneumatic system errors are detected. In Pump Disabled Mode, the pump will remain off in all circumstances.

APNEA ALARM: This performs a function to set the display of apnea message alarm. This displays a “apnea” message at the center of parameter window as shown in the figure below with apnea alarm on in case of apnea until the set apnea period is passed through.

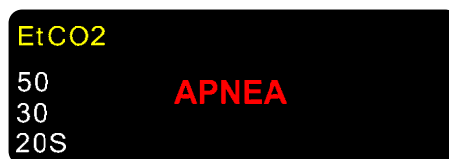

With apnea alarm off, measured values are displayed instead of message.

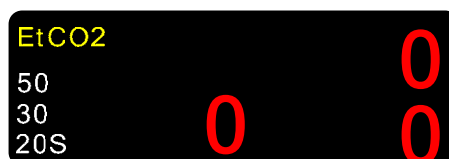

Warning

If defibrillation is performed while doing CO2 monitoring, remove the CO2 FilterLine from patient. Getting in touch with sensor cable without removing the FilterLine can result in serious electrical burn, shock, or injury due to electric discharge energy.

Note

In the following monitoring conditions, the measured values may be inaccurate. Read the measured values carefully.

1. When using this in an environment of using nitrous oxide gas of high concentration
2. When using this in an environment where abrupt temperature change takes place
3. When using this in an environment with severely high humidity.

Caution

- The measured values may be inaccurate when using this equipment for patients who have very fast or irregular respiration.
- When measuring CO2 from the patient under the anesthesia, check it when gas mixture comes in. Otherwise, the measured result values may be inaccurate.
- When using a anesthesia machine that uses a volatile anesthetic, CO2 values may be inaccurate.

11. TEMPERATURE

11.1 Outline

Temperature Connector and Measuring Cable

11.2 Temperature Data Window

11.3 Temperature Data Setup

ALARM LIMIT

UNIT SELECT

11.1 Outline

This function is used to indicate the changes of resistance generated by the changes of temperature in numbers. The function involves the process of transferring the changes into electric signals.

Temperature Connector and Measuring Cable

Temperature Connector

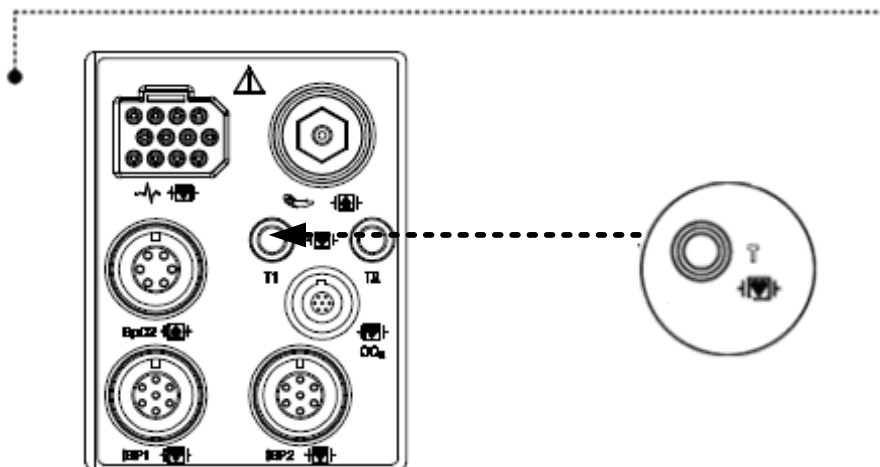

Temperature Measuring Cable



Note

Temperature probe is correctly positioned and fixed to do not disconnect on the patient.
Temperature cable is attached to the monitor.

11.2 Temperature Data Window

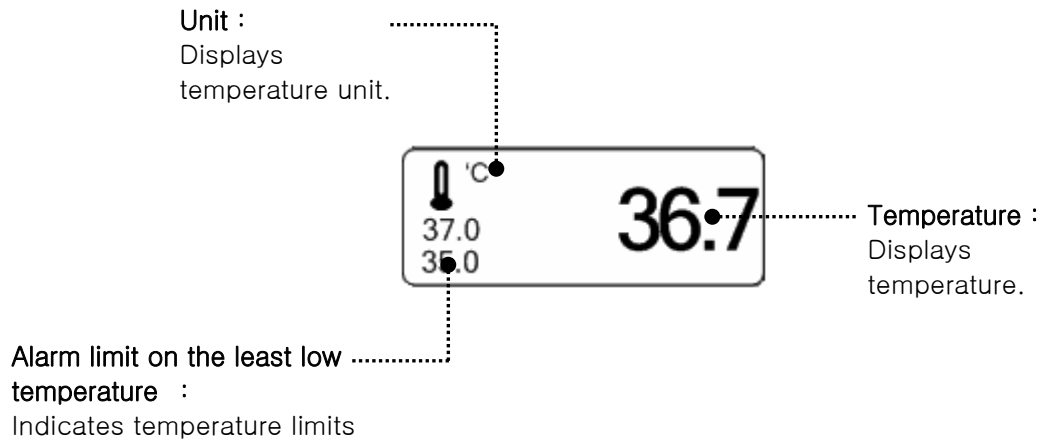

Note

The minimum measuring time required to obtain accurate readings at the specific body site is at least 3 minutes.

11.3 Temperature Data Setup

ALARM : Temperature measurement alarm set

UNIT: Temperature measurement unit set

MAIN MENU	ALARM		UNIT SELECT: °C

ALARM

Alarm menu provide ALARM LIMIT and ALARM SOUND.

MAIN MENU	ALARM LIMIT	ALARM SOUND : ON	
PREV MENU			
MAIN MENU	ALARM LIMIT	ALARM SOUND: ON	
PREV MENU			

ALARM LIMIT

Setting numeric value is 15.0□ ~ 45.0□.

1. Move the □ mark to select either RETURN or TEMP, and press.
2. After pressing the cursor at TEMP, move it to LOW, and press.
3. When the color has changed, move the cursor again to select a target value, and press.
4. Move the cursor to HIGH and press. After the color has changed, move the cursor again to select a target value, and press. (One may choose HIGH first to get the same result.)
5. Select RETURN to get out of the menu.

MAIN MENU	ALARM LIMIT	ALARM SOUND : ON	
PREV MENU			

TEMPERATURE ALARM LIMIT			
RETURN	UNITS	LOW	HIGH
TEMP	°C	30.0	42.0

ALARM SOUND

The menu which decide activate of warning sign and message display when the respiration alarm is on.

MAIN MENU	ALARM LIMIT	ALARM SOUND : ON	
PREV MENU			
MAIN MENU	ALARM LIMIT	ALARM SOUND : OFF	
PREV MENU			

UNIT SELECT

Able to select unit with °C, °F.

MAIN MENU	ALARM		UNIT SELECT: °C
MAIN MENU	ALARM		UNIT SELECT: °F

12. PRINT

12.1 Print

Printer and Heat Sensitivity Paper
Function and Setup Menu

12.2 Paper Change

12.1 Print

Printer and Heat Sensitivity Paper

A printer used to print data onto thermal paper.

Size of the thermal paper roll: 580mm wide x 380mm in diameter any thermal paper of same size can be used for the printer.

Side View of

Printer



Function and Setup Menu

MAIN MENU	PRINTER SPEED: 25mm/s		WAVE FORM1: ECG
PREV MENU	WAVE FORM3: SPO2	WAVE FORM2: RESP	

1. Press the PRINT Key for continuous printing.
2. Select Printing Speed 25, 50 mm/s.

MAIN MENU	PRINTER SPEED: 25mm/s		WAVE FORM1: ECG
PREV MENU	WAVE FORM3: SPO2	WAVE FORM2: RESP	
MAIN MENU	PRINTER SPEED: 50mm/s		WAVE FORM1: ECG
PREV MENU	WAVE FORM3: SPO2	WAVE FORM2: RESP	

3. Set up ALARM PRINT in the MORE menu to activate ALARM during printing.



4. Data is printed in a selected wave form along with personal information of the patient.

3 channels select 3 parameters to print.

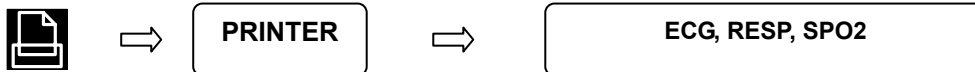

MAIN MENU	PRINTER SPEED: 50mm/s		WAVE FORM1: SPO2
PREV MENU	WAVE FORM3: SPO2	WAVE FORM2: RESP	

MAIN MENU	WAVE FORM1: SPO2	>	OFF SPO2 RESP I	II III aVR aVL	aVF V
PREV MENU					
MAIN MENU	PRINTER SPEED: 50mm/s				WAVE FORM1: LEAD II
PREV MENU	WAVE FORM3: SPO2		WAVE FORM2: RESP		
MAIN MENU	WAVE FORM2: RESP	>	OFF SPO2 RESP I	II III aVR aVL	aVF V
PREV MENU					
MAIN MENU	PRINTER SPEED: 50mm/s				WAVE FORM1: LEAD I
PREV MENU	WAVE FORM3: LEAD II		WAVE FORM2: RESP		
MAIN MENU	WAVE FORM3: LEAD II	>	OFF SPO2 RESP I	II III aVR aVL	aVF V
PREV MENU					



If there is no print sheet, no paper icon of  appears.

12.2 Paper Change

1

.....
Open the window of the printer.



2

.....
Insert the paper roll offered with the product into the printing unit. Place the roll in a proper way so that the printed paper can roll out upwards.



3

.....
Press the printer window until it is properly shut. Inaccurate shutting may cause failure in printing.



13. MESSAGE LIST

Function	Message	Details
ECG	LEAD FAULT CABLE OFF	Cable is not properly attached patient. Cable is not properly connected.
SpO ₂	LEAD FAULT CHECK PROBE PULSE SEARCH POOR SIGNAL LOST PULSE ARTIFACT	Cable is not properly connected. Patient's finger is off the probe. Detection by the monitor of a pulse has ceased. The SpO ₂ signal is too low. The quality of the signal is questionable. The signal is patient's motion artifact
RESP	LEAD FAULT APNEA	Cable is not properly connected. APNEA gives an alarm.
NIBP	INFLATION FAILURE CHECK CUFF OVER PRESSURE DEFLATION FAILURE OVER TIME CUFF PRESSURE MEASUREMENT ERROR	Cuff hose is not properly connected. Cuff pressure is putting on excessively. Cuff is bent, preventing deflation. Measure time exceeds the preset Level. Measure signal absent
TEMP	LEAD FAULT	Cable is not properly connected.
ALARM	ALARM VOL.OFF SILENCED ALARM PAUSE 5MIN	Alarm volume is off. Alarm key is pressed once Alarm key is pressed twice
TREND	NO PATIENT DATA	No patient's data input.
PRINT	NO PAPER	No paper in the printer
SETUP	BATTERY LOW	Low battery

14. FACTORY DEFAULTS

Alarm level (Horse)

Alarm level (Dog)

Alarm level (Cat and Puppy)

Parameter Limits(Horse)

Parameter Limits(Dog)

Parameter Limits(Cat and Puppy)

Alarm level (Horse)

	High	Medium	Low	Message
Asystole	•			
Vfib/VTac	•			
V TAC	•			
HR		•		
NIBP		•		
IBP1		•		
IBP2		•		
ETCO2		•		
FiCO2		•		
SpO₂			•	
SpO₂-Rate				•
RR				•
RR-Apnea				•
TEMP1(° C)				•
TEMP2(° C)				•
PVC/min			•	
ST			•	
BIGEMINY				•
BRADY				•
COUPLET				•
IRREGULAR				•
PAUSE				•
PVC				•
R ON T				•
TRIGEMINY				•
V BRADY	•			
VT > 2	•			
LEAD FAULT			•	
Low Battery		•		

Alarm level (Dog)

	High	Medium	Low	Message
Asystole	•			
Vfib/VTac	•			
V TAC	•			
HR		•		
NIBP		•		
IBP1		•		
IBP2		•		
ETCO2		•		
FiCO2		•		
SpO ₂			•	
SpO ₂ -Rate				•
RR				•
RR-Apnea				•
TEMP1(° C)				•
TEMP2(° C)				•
PVC/min			•	
ST			•	
BIGEMINY				•
BRADY				•
COUPLET				•
IRREGULAR				•
PAUSE				•
PVC				•
R ON T				•
TRIGEMINY				•
V BRADY	•			
VT > 2	•			
LEAD FAULT			•	
Low Battery		•		

Alarm level (Cat and Puppy)

	High	Medium	Low	Message
Asystole	•			
Vfib/VTac	•			
V TAC	•			
HR		•		
NIBP			•	
IBP1		•		
IBP2		•		
ETCO2		•		
FiCO2		•		
SpO₂			•	
SpO₂-Rate				•
RR				•
RR-Apnea	•			
TEMP1(° C)				•
TEMP2(° C)				•
PVC/min			•	
PVC				•
ST			•	
LEAD FAULT			•	
Low Battery		•		

Parameter Limits(Horse)

	Low	High
HR	50	150
NIBP-S	80	200
NIBP-M	40	140
NIBP-D	20	120
SpO₂	90	100
SpO₂-Rate	50	150
RR(RESPI)	10	30
RR-Apnea	0	20
TEMP1(° C/ ° F)	30.0/42.0	86.0/107.6
TEMP2(° C/ ° F)	30.0/42.0	86.0/107.6
IBP1-S	80	200
IBP1-M	40	140
IBP1-D	20	120
IBP1-R	50	150
IBP2-S	-50	350
IBP2-M	-50	350
IBP2-D	-50	350
IBP2-R	50	150
ETCO₂	0	98
FICO₂	0	20
AWRR	0	100
ETCO₂-APNEA	0	40
PVC/min	0	6
ST	-2.0	2.0

Parameter Limits(Dog)

	Low	High
HR	50	150
NIBP-S	80	200
NIBP-M	40	140
NIBP-D	20	120
SpO₂	90	100
SpO₂-Rate	50	150
RR(RESP)	10	30
RR-Apnea	0	20
TEMP1(° C/ ° F)	30.0/42.0	86.0/107.6
TEMP2(° C/ ° F)	30.0/42.0	86.0/107.6
IBP1-S	80	200
IBP1-M	40	140
IBP1-D	20	120
IBP1-R	50	150
IBP2-S	-50	350
IBP2-M	-50	350
IBP2-D	-50	350
IBP2-R	50	150
ETCO₂	0	98
FICO₂	0	20
AWRR	0	100
ETCO₂-APNEA	0	40
PVC/min	0	6
ST	-2.0	2.0

Parameter Limits(Cat and Puppy)

	Low	High
HR	90	200
NIBP-S	40	100
NIBP-M	30	70
NIBP-D	20	60
SpO₂	88	100
SpO₂-Rate	90	200
RR(RESPI)	15	100
RR-Apnea	0	15
TEMP1(° C/ ° F)	30.0/42.0	86.0/107.6
TEMP2(° C/ ° F)	30.0/42.0	86.0/107.6
IBP1-S	80	200
IBP1-M	40	140
IBP1-D	20	120
IBP1-R	50	150
IBP2-S	-50	350
IBP2-M	-50	350
IBP2-D	-50	350
IBP2-R	50	150
ETCO₂	0	98
FICO₂	0	20
AWRR	0	100
ETCO₂-APNEA	0	40
PVC/min	0	6
ST	-2.0	2.0

15. TROUBLE SHOOTING

15.1 Noise in ECG

- Gel is dry
- Electrodes does not stick well to skin

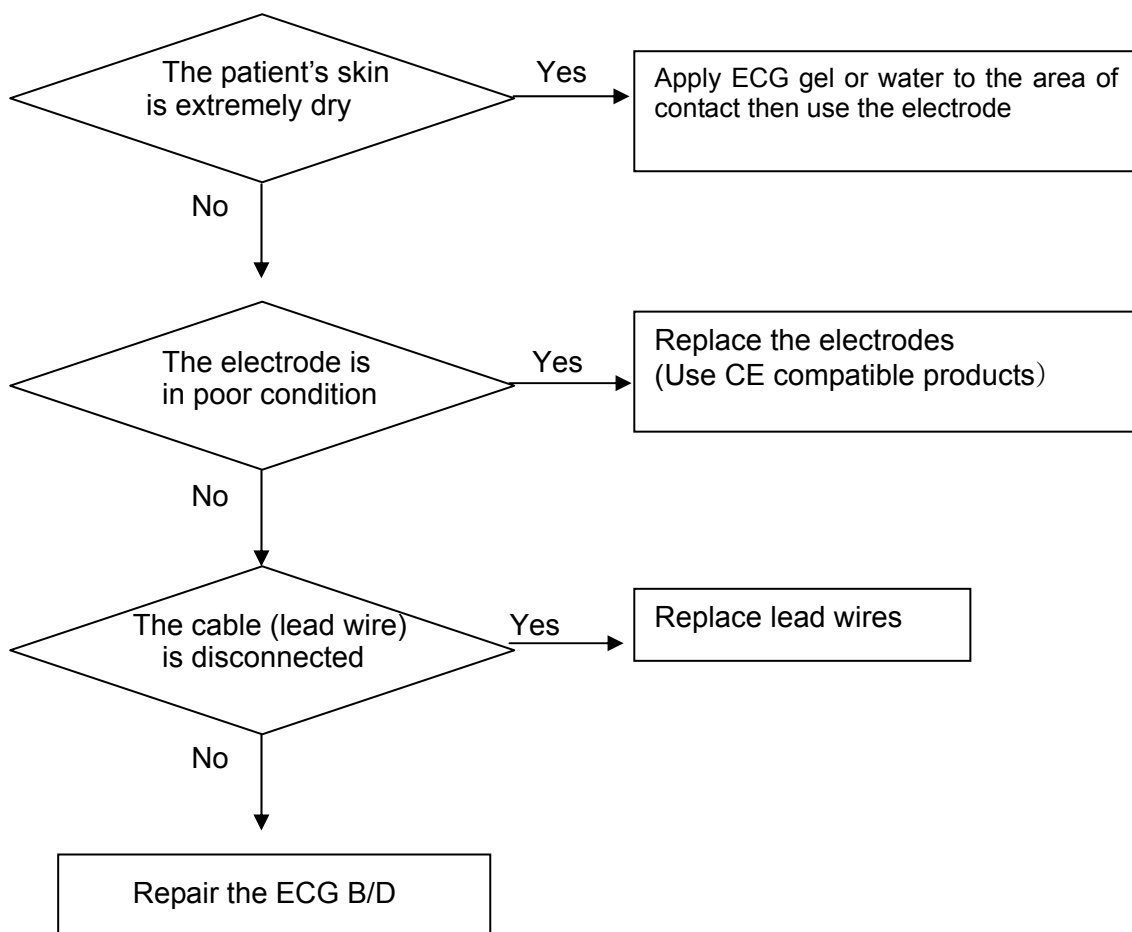

15.2 SpO₂ malfunction

Connectors of the equipments are in bad condition?

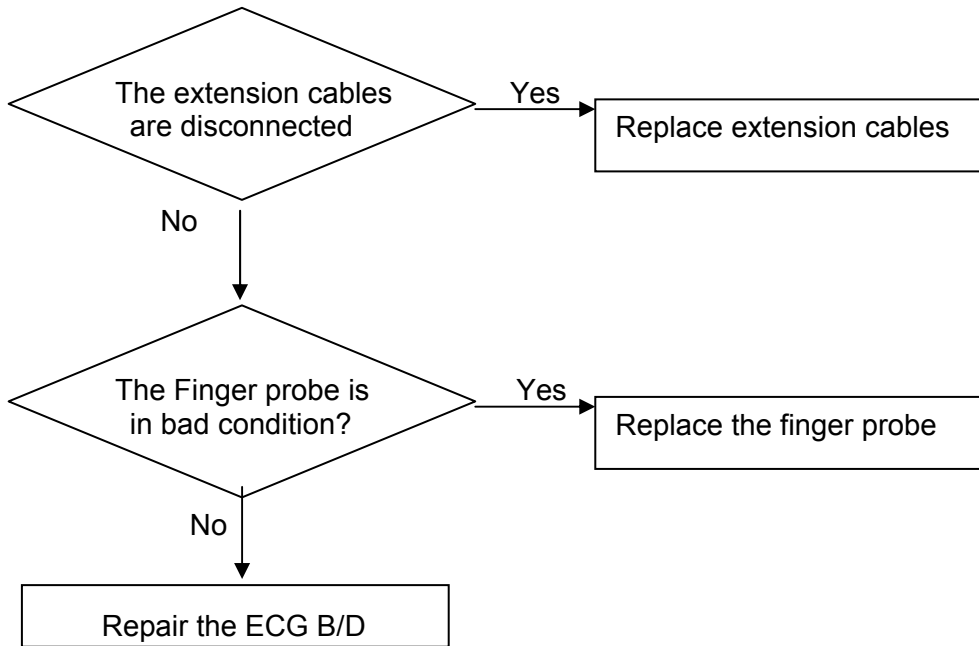

15.3 Temp malfunction

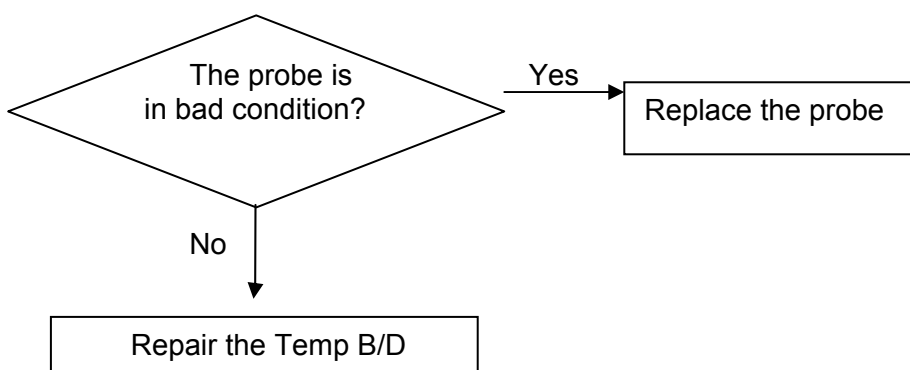

15.4 NIBP malfunction

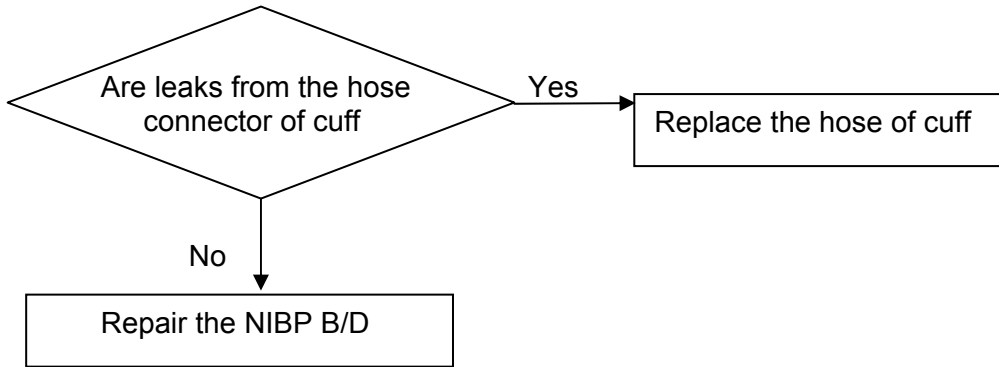

15.5 Abnormality in NIBP measurements

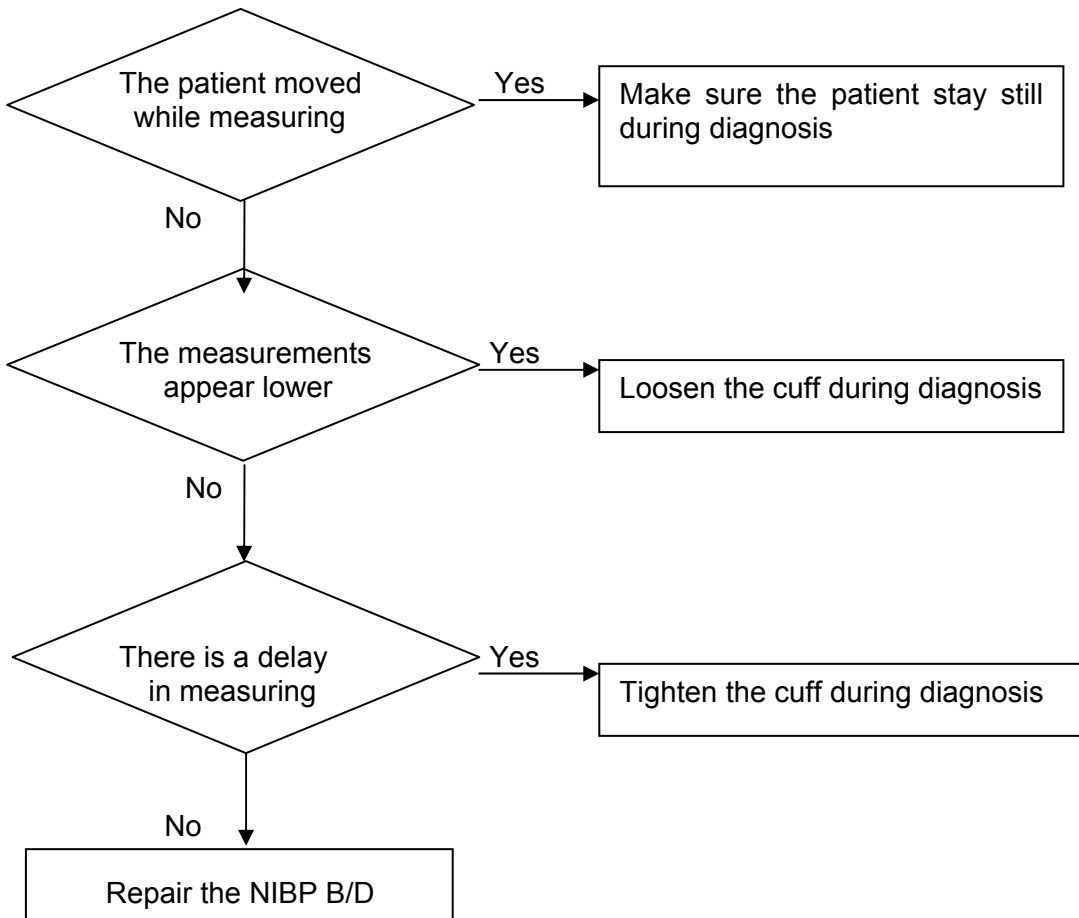

15.6 Failure in battery recharge

(the battery does not fully recharge in 6 hours or more)

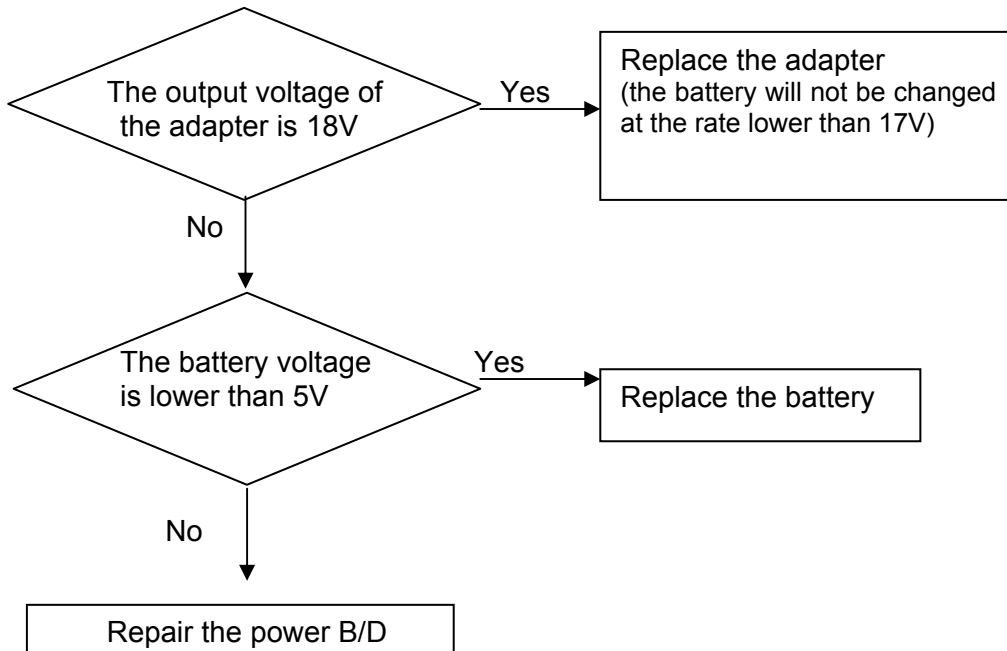

15.7 Power failure

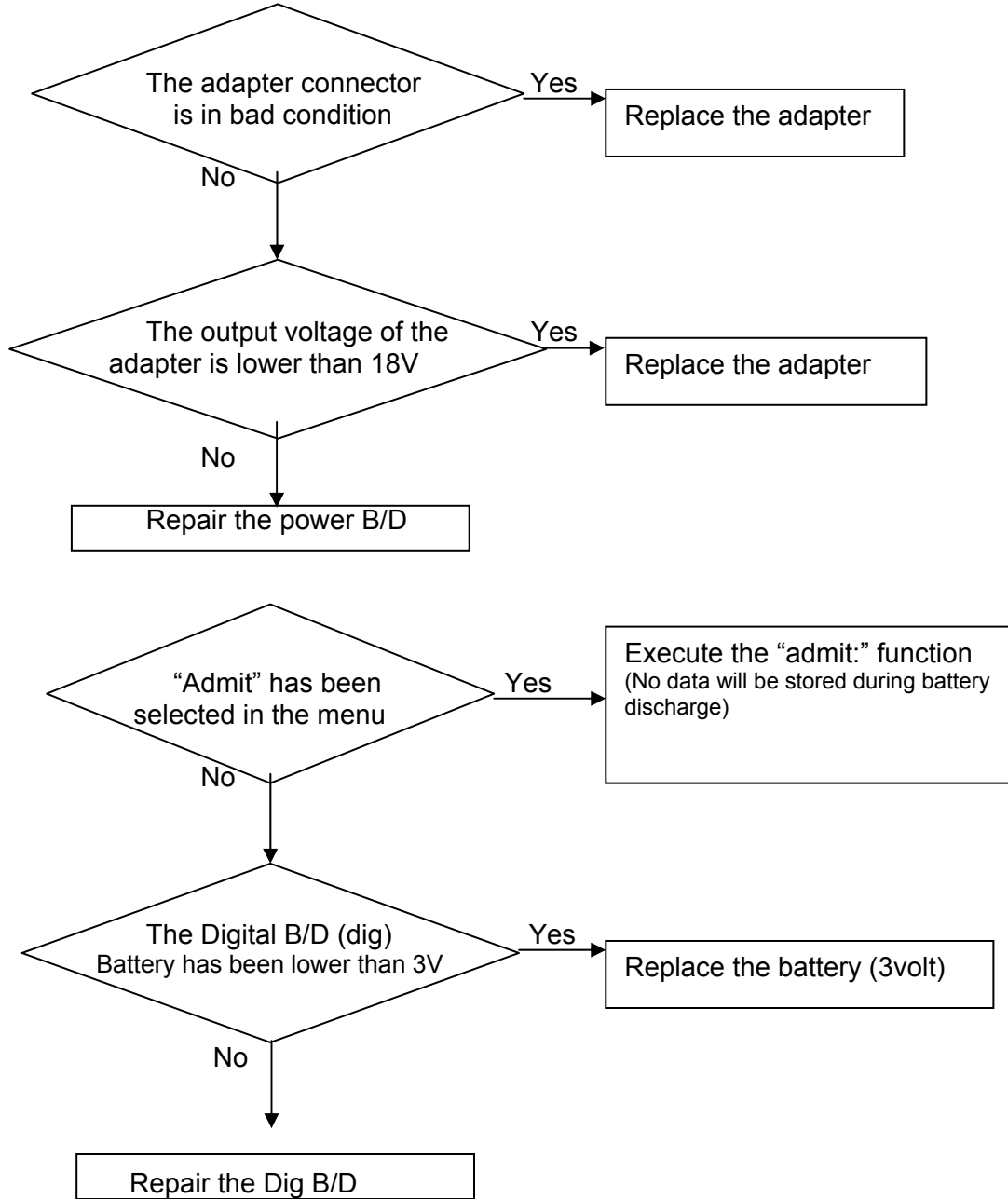

15.8 Periodic noises

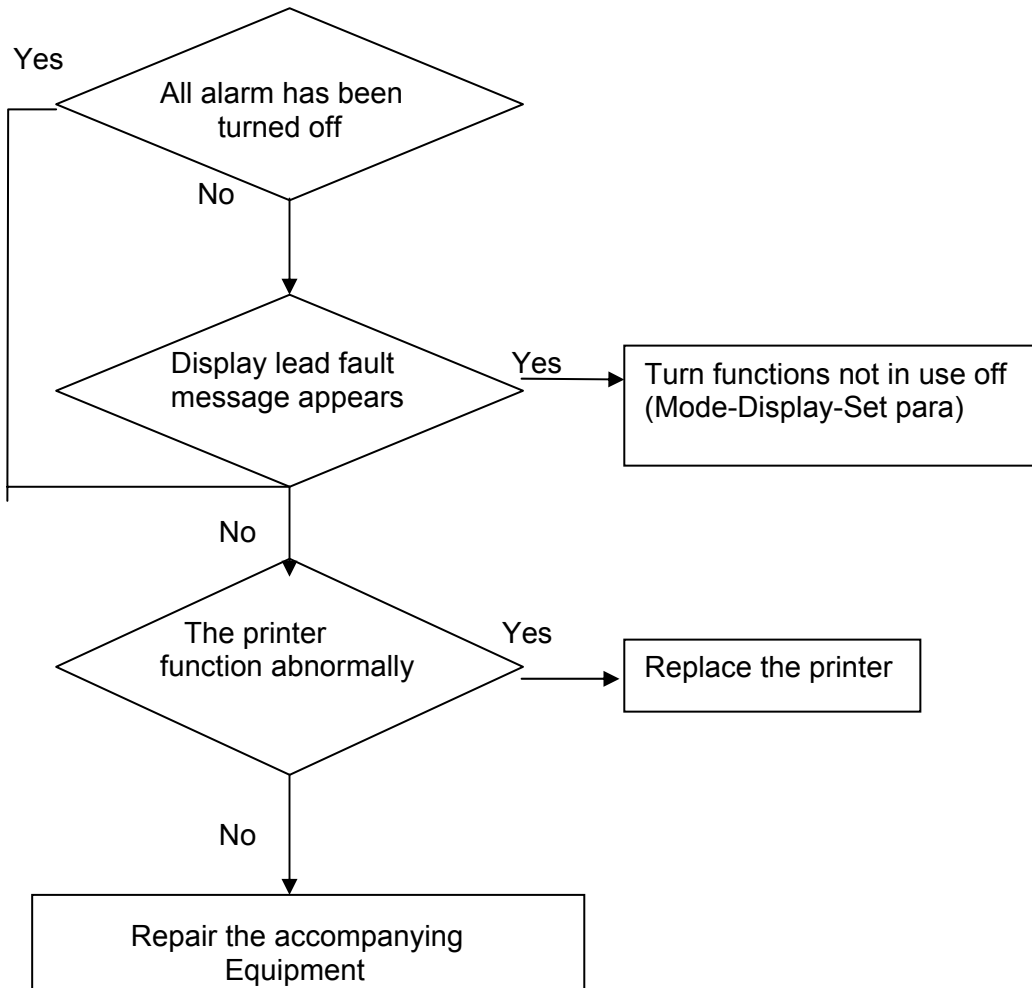

15.9 Print failure

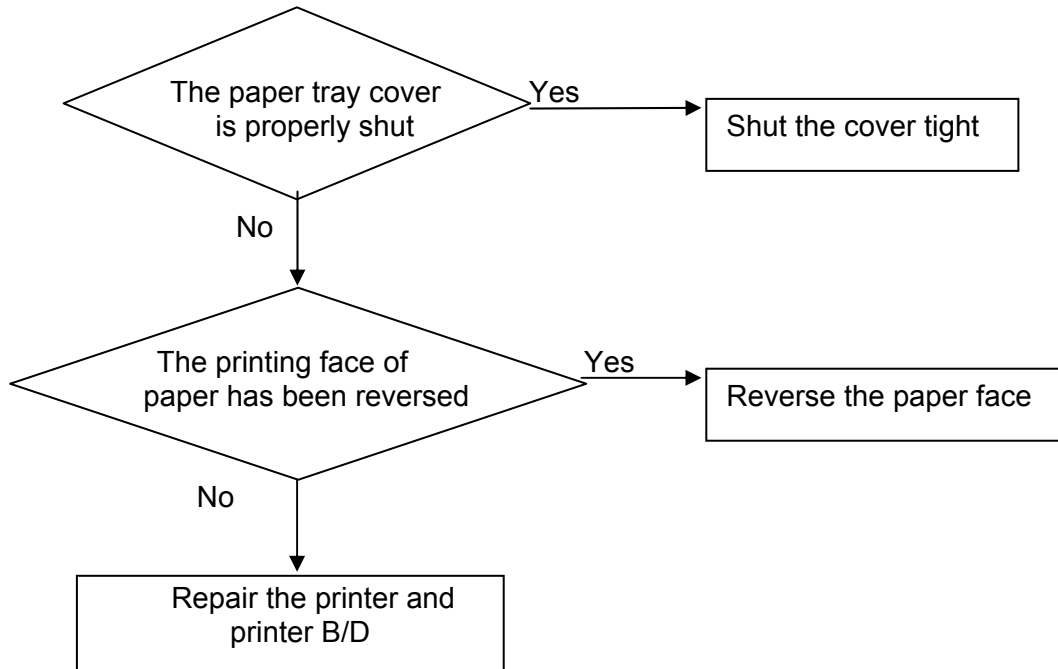

16. SPECIFICATION

Ease of use

Customization

Special Features

Monitor Environmental Specifications

Power adaptor

Monitor Performance Specifications

Graphical and Tabular Trends

SpO2 Performance Specifications

Respirations Performance Specifications

NIBP Performance Specifications

ECG Performance Specifications

Temperature Unit Performance Specifications

Accessories included

OPTION

Ease of use

- Battery operation
- Attached printer
- Table and graphic trend

Additional Function

- Able to use auto mobile power supply
- LAN Connection

Monitor Environmental Specifications

- Operating Temperature : 15°C to 40°C (59°F to 104°F)
- Storage Temperature : - 10°C to 60°C (14°F to 140°F)
- Humidity : 20% to 95% RH
- Operating Attitude : 70(700) to 106Kpa(1060mbar)

Power

- AC 100-240V (50/60Hz)
- Adapter 18 V, 2.5 A

Specification

Display, Resolution	10.4" color TFT, 800 x 600 pixels
Dimension, Weight	270(W) x 250(H) x 184.5(D) mm, Approx. 4.0kg
Parameter	ECG, Heart Rate, Respiration Rate, SpO2, Pulse Rate, Systolic BP, Diastolic BP, Mean BP, 2 x Temperature, 2 x IBP, EtCO2, FiCO2, Airway Respiration Rate
Trace	6 waveforms : 2*ECG, SpO2, RR or EtCO2, 2*IBP Sweep speed : 6.25, 12.5, 25, 50 mm/sec
Indicators	Categorized alarms (3 priority levels), Visual alarm lamp handle Heart beat tone, SpO2 pulse pitch tone Battery status, External power LED
Interfaces	DC input connector : 12 to 18VDC, 2.5A Defibrillator Sync. Output : - Signal Level : 0 to 5V pulse - Pulse width : 100 ± 10 ms LAN digital output for transferring data, Nurse call system connection DC output : 5VDC, 1A Max
Battery	Rechargeable Li-ion battery, 1hours for continuous working
Thermal Printer (option)	Speed : 25, 50mm/sec, Paper width : 58mm
Data Storage	128hours trends, 20cases of 10sec alarm waveform
Language	English, French, Spanish, Italian, Germany, Chinese, Russian, Czech,
ECG Performance	
Lead type	3-lead, 5-lead
Lead Selection	3-lead : I, II, III 5-lead : I, II, III, aVR, aVL, aVF, V
ECG waveforms	3-lead : 1 channel 5-lead : 3/7 channels

BM5VET User's Manual

Heart Rate Range	Adult : 30 – 300 bpm Neonate/Pediatric : 30 – 350 bpm
Heart Rate Accuracy	±1bpm or ±1%, whichever is greater
Sweep speed	6.25, 12.5, 25, 50 mm/sec
Filter	Diagnostic mode : 0.05Hz - 120Hz Monitoring mode : 0.5 – 40 Hz Surgical mode : 0.5 – 25 Hz
S-T segment detection range	-2.0 to 2.0 mV
Arrhythmia analysis	ASYSTOLE,VTACH,VFIB,BIGEMINY,ACCVENT, COUPLET,IRREGULAR, PAUSE,PVC,RONT,TRIGEMINY,VBRADY, SHORTRUN
Pacemaker Detection Mode	Indicator on waveform display (user selectable)
Protection	Against electrosurgical interference and defibrillation
Respiration Performance	
Method	Thoracic impedance
Channel selection	RA-LA or RA-LL
Measurement range	5 – 120 Breath per minute
Accuracy	±1 Breath per minute
Apnea alarm	Yes
SpO2 Performance	
Saturation range	0 to 100%
Saturation accuracy	70 to 100% ±2 digits 0 to 69% unspecified
Pulse rate range	0 to 254 bpm
Pulse rate accuracy	±2 bpm
NIBP Performance	
Method	Oscillometry with linear deflation
Operation Mode	Manual/Automatic/Continuous
Measurement range	Adult Pressure : 20 to 260 mmHg Pediatric Pressure : 20 to 230 mmHg Neonate Pressure : 20 to 120 mmHg
Accuracy	mean error : less than ±5 mmHg standard deviation : less than 8 mmHg
Temperature Performance	
Measurement range	15 to 45°C (59 to 113°F)
Accuracy	±1°C
Compatibility	YSI Series 400 temperature probes
IBP Performance (Option)	
Channels	2
Measurement range	-50 to 300mmHg

Accuracy	<100mmHg : ± 1 mmHg >=100mmHg : $\pm 1\%$ of reading
Pulse rate measurement range	0 to 300bpm
Zero balancing	Range : ± 200 mmHg Accuracy : ± 1 mmHg Drift : ± 1 mmHg over 24hours
Transducer sensitivity	5 μ V/mmHg
Pulse rate measurement range	0 to 300bpm
<i>Microstream CO2 (Option)</i>	
Measurement range	0 to 99 mmHg
Accuracy	0-40 mmHg ± 2 mmHg 41-76 mmHg $\pm 5\%$ of reading, 77-99 mmHg $\pm 10\%$ of reading
Respiration rate	0 to 150 breath per minute
Respiration accuracy	± 1 breath per minute
<i>Sidestream CO2 (Option)</i>	
Measurement range	0 to 150 mmHg, 0 to 19%
Accuracy	0-40mmHg ± 2 mmHg, 41-70mmHg $\pm 5\%$ of reading 71-100mmHg $\pm 8\%$ of reading, 101-150mmHg $\pm 10\%$ of reading
Respiration rate	2 to 150 breath per minute
Respiration accuracy	± 1 breath per minute
<i>Mainstream CO2 (Option)</i>	
Measurement range	0 to 150 mmHg, 0 to 19%
Accuracy	0-40mmHg ± 2 mmHg, 41-70mmHg $\pm 5\%$ of reading 71-100mmHg $\pm 8\%$ of reading, 101-150mmHg $\pm 10\%$ of reading
Respiration rate	0 to 150 breath per minute
Respiration accuracy	± 1 breath per minute

Accessories Included:

1. Main body of BM5VET Monitor	1 EA
2. 3-Lead Patient Cable (3CBL-400, 3WIRE-430)	1 EA
3. NIBP extension tube (3m, NBPCBL-400)	1 EA
4. Reusable NIBP cuff (25-35 cm, ACUFF-430)	1 EA
5. SpO ₂ sensor extension cable (2m, SPCBL-400)	1 EA
6. Reusable SpO ₂ sensor (SPASENS-400)	1 EA
7. DC Power Adaptor with Power Cord (18VDC/2.5A, KA1803F52)	1 EA
8. Operator's Manual	1 EA
9. Chart Paper (PAPER-400)	2Roll

Option

1. Reusable Temperature Probe (Surface/Skin, TEMPESENS-430)	1EA
2. IBP Transducer Set (Disposable/Reusable)	1SET
3. Capnography Station (Microstream EtCO ₂ , Oridion)	1SET
4. Sidestream EtCO ₂ Module (Respironics)	1SET
5. Mainstream EtCO ₂ Module (Respironics)	1SET
6. Microstream EtCO ₂ airway adapter aampling kit	1EA
7. Sidestream EtCO ₂ airway adapter sampling kit	1EA
8. Mainstream EtCO ₂ airway adapter	1EA

Abbreviations and Symbols

Abbreviations and symbols which you may encounter while reading this manual or using the monitor are listed below with their meanings.

Abbreviations

		A
A	amps	
AC	alternating current	
ADT	adult	
ARRHYTHM	arrhythmia	
ASYS	asystole	
Auto, AUTO	automatic	
AUX	Auxiliary	
aVF	left foot augmented lead	
aVL	left arm augmented lead	
aVR	right arm augmented lead	
		B
BPM	beats per minute	
		C
C	Celsius	
CAL	calibration	
cm, CM	centimeter	
		D
D	diastolic	
DC	direct current	
DEFIB, Defib	defibrillator	
DIA	diastolic	
		E
ECG	electrocardiograph	
EMC	electromagnetic compatibility	
EMI	electromagnetic interference	
ESU	electrosurgical cautery unit	
		F
F	Fahrenheit	
		G
g	gram	
		H
HR	heart rate, hour	
Hz	hertz	
		I
ICU	intensive care unit	
Inc	incorporated	

		K
kg, KG	kilogram	
kPa	kilopascal	
		L
L	liter, left	
LA	left arm, left atrial	
LBS	pounds	
LCD	liquid crystal display	
LED	light emitting diode	
LL	left leg	
		M
M mean,	minute	
m	meter	
MIN,	min minute	
MM, mm	millimeters	
MM/S	millimeters per second	
MMHG, mmHg	millimeters of mercury	
mV	millivolt	
		N
NIBP	noninvasive blood pressure	
NEO, Neo	neonatal	
		O
OR	operating room	
		P
PED	pediatric	
PVC	premature ventricular complex	
		Q
QRS	interval of ventricular depolarization	
		R
RA	right arm, right atrial	
RESP	respiration	
RL	right leg	
RR	respiration rate	
		S
S	systolic	
sec	second	
SpO2	arterial oxygen saturation from pulse oximetry	
SYNC, Sync	synchronization	
SYS	systolic	
		T
Temp, TEMP	temperature	
		U
		V
V	precordial lead	
V	volt	
V-Fib, VFIB	ventricular fibrillation	

VTAC ventricular tachycardia

W

X

X multiplier when used with a number (2X)

Symbols

& and
° degree(s)
> greater than
< less than
- minus
number
% percent
± plus or minus

PRODUCT WARRANTY

Product Name	Patient Monitor
Model Name	BM5VET
Approval Number	
Approval Date	
Serial Number	
Warranty Period	1 year from date of purchase (2 years in Europe)
Date of Purchase	
Customer Section	Hospital Name : Address : Name : Phone :
Sales Agency	
Manufacturer	

* Thank you for purchasing BM5VET.

* The product is manufactured and passed through strict quality control and through inspection.

* Compensation standard concerning repair, replacement, refund of the product complies with "Consumer's Protection Law" noticed by Economic Planning Dept.

GIMA WARRANTY CONDITIONS

Congratulations for purchasing a GIMA product.

This product meets high qualitative standards both as regards the material and the production.

The warranty is valid for 12 months from the date of supply of GIMA.

During the period of validity of the warranty, GIMA will repair and/or replace free of charge all the defected parts due to production reasons. Labor costs and personnel traveling expenses and packaging not included.

All components subject to wear are not included in the warranty.

The repair or replacement performed during the warranty period shall not extend the warranty.

The warranty is void in the following cases: repairs performed by unauthorized personnel or with non-original spare parts, defects caused by negligence or incorrect use.

GIMA cannot be held responsible for malfunctioning on electronic devices or software due to outside agents such as: voltage changes, electro-magnetic fields, radio interferences, etc.

The warranty is void if the above regulations are not observed and if the serial code (if available) has been removed, cancelled or changed.

The defected products must be returned only to the dealer the product was purchased from.

Products sent to GIMA will be rejected.

Disposal

Disposal: The product must not be disposed of along with other domestic waste.

The users must dispose of this equipment by bringing it to a specific recycling point for electric and electronic equipment.

For further information on recycling points contact the local authorities, the local recycling center or the shop where the product was purchased. If the equipment is not disposed of correctly, fines or penalties may be applied in accordance with the national legislation and regulations.



BIONET Co., Ltd. #1101, E&C Dream Tower III, 197-33, Guro-Dong, Guro-Gu, 152-848 Seoul - Korea



MGB Endoskopische Geräte GmbH Berlin, Schwarzschildstr. 6, 12489 Berlin - GERMANY