

Product Information

Ambu[®] **AuraOnce**[™]

Single Use Laryngeal Mask - Sterile

For use by trained clinicians only



Product information

This product information may be updated without further notice. Copies of the current version are available from the manufacturer.

Contents	Page
1. Warnings/Cautions	3
2. Introduction	4
2.1. Intended use	4
2.2. Contraindications	4
3. Specifications	4
3.1. Materials	5
4. Principles of operation	6
5. Adverse effects	6
6. Preparation for use	6
6.1. Functional testing	6
6.1.1. Test 1 - Visual inspection	7
6.1.2. Test 2 - Inflation/deflation test	7
7. Insertion	8
7.1. Pre-insertion preparation	8
7.2. Insertion	8
7.3. Insertion techniques	8
7.3.1. Placement technique	9
7.4. Insertion problems	9
7.5. Inflation	9
7.6. Connecting to the anesthetic system	10
7.7. Fixation	10
7.8. Usage with spontaneous ventilation	11
7.9. Usage with positive pressure ventilation	11
7.10. Critical observations during use	11
7.11. Recovery	12
7.12. Removal procedure	12
8. Specialized use	12
8.1. Intubation through the Ambu AuraOnce	12
8.2. Use of the Ambu AuraOnce for blind tracheal intubation	13
8.3. Pediatric Use	13
8.4. Critical situations and emergencies	13
8.4.1. Critical situations	13
8.4.2. Emergencies	13
8.5. Magnetic resonance imaging (MRI)	13
Illustration	14-15
Symbols	16
Addresses	17

US: Rx only

Ambu® is registered trademark of Ambu A/S, Denmark.
Ambu A/S is certified according to ISO 9001, and ISO 13485.

1. Warnings/Cautions

Throughout these directions for use, appropriate warnings are given describing potential safety hazards associated with use of the Ambu AuraOnce.

WARNING



The user should be familiar with the following warnings prior to use of the Ambu AuraOnce.

- The Ambu AuraOnce is delivered sterile.
- Lubricate only the posterior tip of the cuff to avoid blockage of the airway aperture or aspiration of the lubricant.
- To avoid trauma, do not use force at any time during insertion of the Ambu AuraOnce.
- Adhere strictly to the recommended cuff inflation volumes as specified in Table 3. Never over-inflate the cuff after insertion.
- Ambu AuraOnce is to be used in patients, who have been clinically evaluated by a clinician familiar with anaesthesia as eligible for a Supraglottic Airway Device.
- In patients with severe oropharyngeal trauma, the Ambu AuraOnce should only be employed when all other attempts to establish an airway have failed.
- The Ambu AuraOnce is flammable in the presence of lasers and electrocautery equipment.
- Use of a nasogastric tube may make regurgitation likely because the tube may interfere with the function of the lower esophageal sphincter.
- Do not attempt to clean and reuse the Ambu AuraOnce.

CAUTION



- US federal law restricts this device to be sold to or on the order of a physician.
- For use only by clinicians trained in the use of a Ambu AuraOnce.
- Ensure that the device is not in any way damaged before use
- Make a brief functional check as described in section 6 before using the device. Failure of any test indicates that the device should not be used.
- If airway problems persist or ventilation is inadequate, the Ambu AuraOnce should be removed and reinserted or a secure airway established by other means.
- Patients should be adequately monitored at all times during use.
- The secure function of all anaesthetic breathing system connectors should be checked before the breathing circuit is established.
- To minimize contamination, always wear gloves during the preparation and insertion of the Ambu AuraOnce.
- Have a spare Ambu AuraOnce ready and prepared for immediate use.
- When used with MRI, care should be taken to monitor the patient carefully to ensure that correct positioning of the tube is maintained.

2. Introduction

2.1. Intended use

The Ambu AuraOnce is intended for use as an alternative to a facemask for achieving and maintaining control of the airway during routine and emergency anaesthetic procedures in fasted patients.

The Ambu AuraOnce may also be used where unexpected difficulties arise in connection with airway management.

The mask may also be preferred in some critical airway situations.

The Ambu AuraOnce may also be used to establish a clear airway during resuscitation in profoundly unconscious patients with absent glossopharyngeal and laryngeal reflexes who may need artificial ventilation.

The device is not intended for use as a replacement of the endotracheal tube, and is best suited for use in surgical procedures where tracheal intubation is not deemed necessary.

2.2. Contraindications

The Ambu AuraOnce does not protect the patient from the consequences of regurgitation and aspiration. Ambu AuraOnce should only be used in patients, who have been clinically evaluated by a clinician familiar with anesthesia, as eligible for a laryngeal mask airway.

When the Ambu AuraOnce is used in profoundly unconscious patients in need of resuscitation or in an emergency patient with a difficult airway situation (i.e. "cannot intubate, cannot ventilate"), there is a risk of regurgitation and aspiration. This risk must be carefully balanced against the potential benefit of establishing an airway (see the guidelines established by your own local protocol). The Ambu AuraOnce should not be used for resuscitation or emergency treatment of patients who are not profoundly unconscious and who may resist insertion.

3. Specifications

The Ambu AuraOnce function is in conformity with Council Directive 93/42/EEC concerning Medical Devices and ASTM standard no. ASTM F 2560-06 Standard Specification for Supralaryngeal Airways and Connectors. A summary of the methods, materials, data and results of clinical studies that validate the requirements of this standard is available on request, if applicable.



The Ambu AuraOnce is a sterile and single use device.

See figure ①. Ambu AuraOnce.

	Mask size							
	#1	#1½	#2	#2½	#3	#4	#5	#6
① Airway connector	15 mm male (ISO 5356-1)							
② Min. I.D. Tube	5,2 mm	7,3 mm	8,6 mm	8,5 mm	8,5 mm	9,6 mm	10,6 mm	11,3 mm
② Max. O.D. Tube	10,5 mm	13 mm	15 mm	17,5 mm	17,5 mm	20 mm	22,5 mm	25 mm
④ Inflation Valve	Luer cone (ISO 594-1)							
Appropriate storage temperature	10 °C (50 °F) to 25 °C (77 °F)							
Dimensions (mm) (length x width x height)	97x 24x70	112x 29x82	128x 34,5x95	148x 41x109	148x 49x116	168x 56x132	187x 64x148	200x 69x165
Weight	9,2 g	13,4 g	19,3 g	27,8 g	30,8 g	43,7 g	59,9 g	75,1 g
Internal volume of ventilatory pathway	5,5 ml	8 ml	11 ml	15 ml	16 ml	21 ml	30 ml	38 ml
Pressure drop	<1,2 cmH ₂ O at 15 l/min	<0,8 cmH ₂ O at 15 l/min	<1,0 cmH ₂ O at 30 l/min	<0,8 cmH ₂ O at 30 l/min	<2,0 cmH ₂ O at 60 l/min	<1,2 cmH ₂ O at 60 l/min	<0,8 cmH ₂ O at 60 l/min	<0,5 cmH ₂ O at 60 l/min
Min. interdental gap	15 mm	17 mm	19 mm	21 mm	25 mm	29 mm	31 mm	32 mm
⑦ Internal pathway	10,3 cm	12,0 cm	13,8 cm	15,9 cm	15,9 cm	17,8 cm	20,0 cm	22,0 cm

Table 1. Specifications for the Ambu AuraOnce

3.1. Materials

The Ambu AuraOnce is 100% latex free. The materials used for the product and packaging are:

Part	Material
① Airway connector	Polypropylene (PP)
②/③ Tube/Cuff	PVC Medical compound
④ Pilotballoon with inflationvalve	PVC/PC/Silicone
⑥ Pilot tube	PVC Medical compound
Packaging - Vacuum shaped tray	GPET
Packaging - Pouch	Tyvek

Table 2. Material used for the Ambu AuraOnce

See figure ① Ambu AuraOnce

4. Principles of operation

The Ambu AuraOnce comes in eight different sizes for use in patients of different weight. See table below for selection guidelines and max. inflation volumes. Please note that the cuff inflation volumes shown in table 3 are maximum volumes. Applying the stated maximum inflation volume may respond to a cuff pressure above the maximum of 60 cm H₂O. It is recommended to continuously monitor the cuff pressure.

	Mask size							
	#1	#1½	#2	#2½	#3	#4	#5	#6
Patient weight	<5 kg	5-10 kg	10-20 kg	20-30 kg	30-50 kg	50-70 kg	70-100 kg	>100 kg
Maximum cuff inflation volume	4 ml	7 ml	10 ml	14 ml	20 ml	30 ml	40 ml	50 ml
Maximum intracuff pressure	60 cm H ₂ O							

Table 3. Selection guidelines for the Ambu AuraOnce

The mask is designed to conform with the contours of the hypopharynx with its lumen facing the laryngeal opening. When correctly inserted, the distal tip of the cuff rests against the upper oesophageal sphincter.

See figure ②. Correct position of the Ambu AuraOnce in relation to anatomical landmarks

Anatomical Landmarks		AuraOnce parts
A - Esophagus	G - Hyoid bone	1 - Patient end
B - Trachea	H - Tongue	2 - Size marking
C - Cricoid ring	I - Buccal cavity	3 - Ventilatory opening
D - Thyroid cartilage	J - Nasopharynx	4 - Ventilatory pathway
E - Laryngeal inlet	K - Incisors	5 - Normal depth of insertion marks
F - Epiglottis		6 - Machine end

Table 4. Description of anatomical landmarks and Ambu AuraOnce parts

5. Adverse effects

Use of the Ambu AuraOnce may cause minor adverse effects (e.g., sore throat) and major adverse effects (e.g., aspiration).

6. Preparation for use

6.1. Functional testing

Functional testing as described below must be carried out before using the device. The tests should be conducted in a manner consistent with accepted medical practice that minimizes contamination of the Ambu AuraOnce prior to insertion.

CAUTION



- Handle the Ambu AuraOnce carefully as it is made of PVC which can be torn or punctured. Avoid contact with sharp or pointed objects.
- Always wear gloves during the preparation and insertion of the Ambu AuraOnce to minimize contamination.
- Make sure that the cuff protector has been removed from the cuff

WARNING 

- Do not use the device if any test fails.
- Dispose of the Ambu AuraOnce in a safe manner according to local guidelines of medical waste.

6.1.1. Test 1 - Visual inspection

Closely examine the Ambu AuraOnce for any damage, such as perforation, scratches, blockage, loose parts, etc. Do not use the Ambu AuraOnce if it is damaged in any way.

6.1.2. Test 2 - Inflation/deflation test

Ambu recommends to deflate the cuff of the Ambu AuraOnce completely. Once deflated, check the cuff thoroughly for any wrinkles or folds. Over-inflate the cuff to the appropriate volume as specified in Table 5. Check that the inflated cuff is symmetrical and smooth. There should not be any bulge nor any sign of leakage in the cuff, pilot tubing or pilot balloon.

WARNING 

Do not use the Ambu AuraOnce if there are any bulges on the cuff or if there are any signs of leakage.

	Mask size							
	#1	#1½	#2	#2½	#3	#4	#5	#6
Over-inflation cuff volumes	6 ml	10 ml	15 ml	21 ml	30 ml	45 ml	60 ml	75 ml

Table 5. Test cuff over-inflation volumes for the Ambu AuraOnce

CAUTION 

The inflation volumes specified in Table 5 are for testing purposes only. These volumes are not to be used during normal use of the device – the recommended standard inflation volumes can be found in Table 3.

7. Insertion

7.1. Pre-insertion preparation

Before insertion Ambu recommends to deflate the cuff completely so that the cuff is flat and free of wrinkles. Simply press the cuff down onto a flat sterile surface (e.g. a piece of sterile gauze) while at the same time deflating the device with a syringe. Complete deflation results in a shape similar to the rim of a saucer, and facilitates insertion and correct positioning of the device.

Studies show that insertion of the laryngeal mask airway with the cuff either deflated or partly inflated is equally successful in experienced hands. Therefore the clinician can insert the Ambu AuraOnce with a deflated or partly inflated cuff, since both ways works successfully.

See figure ③. Deflation of Ambu AuraOnce.

WARNING

Lubricate only the posterior tip of the cuff to prevent blockage of the airway aperture or aspiration of the lubricant.

To further facilitate insertion into the patient, a sterile, water-based lubricant (e.g. K-Y Jelly®) should be applied to the distal posterior surface of the cuff (local anaesthesia is not recommended).

7.2. Insertion

Before insertion, it is essential that all clinicians using the Ambu AuraOnce are familiar with the warnings, precautions, indications, and contraindications found in these Product Information.

The following points are extremely important:

- Check for correct deflation and lubrication as described above.
- The size of the Ambu AuraOnce must fit the patient. Use the guidelines in Table 3 combined with clinical judgement to select the correct size.
- Always have a spare Ambu AuraOnce ready for use.
- Pre-oxygenate and use standard monitoring procedures.
- Check that the level of anaesthesia (or unconsciousness) is adequate before attempting insertion.
- The head of the patient should be position extended with flexion of the neck in a position normally used for tracheal intubation (i.e. "the sniffing position").
- Never use excessive force.

7.3. Insertion Techniques

There are many insertion techniques currently in use. Insert the Ambu AuraOnce in accordance with currently accepted medical techniques. One commonly used technique is the Pencil Insertion Technique, which is described below.

When inserting the Ambu AuraOnce correctly, you must be careful about the following: Ensure that the cuff tip avoids entering the valleculae or the glottic opening and does not become caught up against the epiglottis or the arytenoids. The cuff should be deflated and pressed against the patient's posterior pharyngeal wall.

When the mask is in place, resistance will be felt.

7.3.1. Placement Technique

Provided that access to the patient's head from above is feasible, the Pencil Insertion Technique provides better positioning than other insertion techniques. The airway tube is held like a flute, with three fingers placed above the junction of the cuff and the tube (Figure 4) and the thumb on the vertical line on the airway tube, which is oriented anteriorly toward the patient's nose. Your other hand should be placed under the patient's head.

See figure ④. Positioning the Ambu AuraOnce using the Pencil Insertion Technique

Insert the tip of the cuff pressing upwards against the hard palate and flatten the cuff against it. Look carefully into the mouth to verify that the tip of the cuff is correctly flattened against the palate before proceeding – push the jaw gently downwards with your middle finger to open the mouth further.

See figure ⑤. Positioning the Ambu AuraOnce using the Pencil Insertion Technique

As the tip of the cuff is placed correctly in the mouth opening, continue the movement by swinging the mask inward with a circular motion, pressing the contours of the hard and soft palate. Then advance the Ambu AuraOnce into the hypopharynx until a definite resistance is felt (Figure 5). The motion of the placement should be smooth. Do not use force. The Ambu AuraOnce should now be correctly located with its tip resting against the upper esophageal sphincter.

7.4. Insertion Problems

Coughing and breathholding during Ambu AuraOnce insertion indicates inadequate depth of anaesthesia – immediately deepen anaesthesia with inhalational or intravenous agents, and initiate manual ventilation.

If you cannot open the patient's mouth sufficiently to insert the mask, check that the patient is adequately anesthetized. Ask an assistant to pull the jaw downwards thus making it easier to see into the mouth and verify the position of the mask.

Difficulty in manoeuvring the angle at the back of the tongue is one of the most common problems encountered when inserting the Ambu AuraOnce. The tip must be pressed against the palate throughout or else the tip may fold on itself or meet an irregularity in the posterior pharynx, e.g. hypertrophied tonsils. Should the cuff fail to flatten or begin to curl over as it is inserted, withdraw the mask and reinsert it. In case of tonsillar obstruction, a diagonal movement of the mask is recommended.

WARNING



Force should never be used during insertion.

7.5. Inflation

After insertion, the vertical line on the airway tube should be oriented anteriorly towards the patient's nose. The typical range of intended depth insertion is marked by the two horizontal lines on the airway tube (see figure ②, item 5). The Ambu AuraOnce is inserted correctly when the patient's incisors are between these markings.

Reposition the mask if the patient's incisors are outside this range. Without holding the tube, inflate the cuff with just enough air to obtain a seal, equivalent to intracuff pressures of approximately 60 cm H₂O. In many cases, only half of the maximum volume is sufficient to achieve a seal – please refer to Table 3 for maximum volumes. Check the cuff pressure continuously during the surgical procedure, either with a cuff pressure gauge or by feeling the tension in the pilot balloon. This is especially important when N₂O gases are used.

See figure ⑥. Inflation of Ambu AuraOnce.

Never over-inflate the cuff. Avoid prolonged intracuff pressures greater than 60 cm H₂O. The initial cuff pressure varies according to patient, mask size, head position, and depth of anaesthesia.

Do not hold the tube during inflation as this prevents the mask from seating itself correctly. A small outward movement of the tube may be seen as the mask is inflated.

To avoid over inflation, it is very important to strictly adhere to the cuff-inflation volumes stated in Table 3.

Over-inflation can be entirely avoided by completely deflating the cuff prior to insertion by withdrawing all of the air with a suitable syringe. This is the method recommended by Ambu.

In instances where an alternative technique is adopted, for example, if the cuff is inserted in a neutral or semi-inflated state, there is a risk that the cuff may be over-inflated. Once the mask is inserted extra care must be taken to compensate for the air already in the mask when subsequently inflating the cuff. The maximum extra volume depends on mask size and initial volume of air in the mask when inserted.

WARNING



Never overinflate the cuff after insertion.

Look for the following signs of correct placement: The possible slight outward movement of the tube upon cuff inflation, the presence of a smooth oval swelling in the neck around the thyroid and cricoid area, or no cuff visible in the oral cavity.

7.6. Connecting to the Anaesthetic System

Carefully connect the Ambu AuraOnce to the anaesthetic circuit or ventilation bag and initiate gentle manual ventilation, looking for any signs of leakage. Auscultation over the lungs and epigastrium and capnography should be used to determine sufficient respiration. Auscultate in the anterolateral neck region to check for abnormal sounds that might indicate mild laryngeal spasm or light anaesthesia.

The mask may leak slightly for the first three or four breaths before settling into position in the pharynx. In case leakage persists, check that there is adequate depth of anaesthesia and that the pulmonary inflation pressures are low before assuming that reinsertion of the Ambu AuraOnce is necessary.

As with other methods of airway management, use of pulse oximetry and capnography is recommended when using the Ambu AuraOnce. The mask can be used for either spontaneous or controlled ventilation.

WARNING



- Any signs of airway problems or inadequate ventilation must be monitored regularly and the Ambu AuraOnce must be replaced or removed as required to maintain a patent airway.
- During anaesthesia, nitrous oxide may diffuse into the cuff causing an increase in cuff volume/pressure. Cuff pressure should be monitored and adjusted routinely.
- The anaesthetic breathing system must be adequately supported when connected to the Ambu AuraOnce to avoid rotation of the mask.
- The patency of the Ambu AuraOnce should be reconfirmed after any change in the patient's head or neck position

7.7. Fixation

Secure the Ambu AuraOnce to the patient's face with adhesive tape or with a mechanical tube holder suited for this purpose. Do not use an oral Guedel airway as a bite block because it will prevent correct positioning of the mask increasing the risk of trauma and reducing seal effectiveness. It is recommended to use a gauze bite block.

See figure ⑦. Fixation of Ambu AuraOnce.

In order to prevent stimulation of the patient's airway do not reposition or move the laryngeal mask during use and avoid moving the patient during anaesthesia to prevent stimulation of the airway.

WARNING

Avoid disturbing the mask during use.

7.8. Usage with Spontaneous Ventilation

The Ambu AuraOnce is suitable for spontaneously breathing patients when used with volatile agents or intravenous anaesthesia on condition that anaesthesia is adequate to match the level of surgical stimulus and the cuff is not overinflated.

Coughing, breath-holding, or movement may occur if the level of anaesthesia is inadequate for maintenance. This may well occur following the introduction of an external stimulus such as surgery or turning the patient if the level of anaesthesia has been misjudged. Gently assist ventilation until breathing returns.

7.9. Usage with Positive Pressure Ventilation

Before using the Ambu AuraOnce with positive pressure ventilation (PPV), the operator should first acquire experience in its usage in spontaneously breathing patients.

Choose a ventilatory pattern giving peak airway pressures less than 20 cmH₂O and tidal volumes less than 8 ml/kg while the capnography is closely monitored.

In the event of leakage occurring during PPV, check for the following:

- light anaesthesia causing a degree of glottis closure
- inadequate neuromuscular block
- a reduction in lung compliance related to the surgical or diagnostic procedure
- displacement of the Ambu AuraOnce by head turning or traction.

After identifying the cause of the leakage, take appropriate corrective measures.

If leakage should occur around the cuff, **do not simply add more air**. This will not necessarily improve the seal pressure and may even increase the leak by adding tension to the normally soft cuff, pushing it away from the larynx. Instead remove the mask and reinsert while providing that anaesthetic depth is adequate.

7.10. Critical observations during use

Inadequate level of anaesthesia: The most likely problem following insertion is failure to maintain an adequate level of anaesthesia. Administer an additional bolus of induction agent and/or increase the concentration of volatile agent while gently assisting ventilation.

Incorrect positioning of the Ambu AuraOnce can be assessed by capnography, the observation of equal movements or by observation of changes in tidal volume, e.g. a reduction in expired tidal volume. If you suspect that the Ambu AuraOnce has been positioned incorrectly, remove and reinsert – and provide that anaesthetic depth is adequate.

Unexpected regurgitation: Regurgitation may occur even in fasted patients. This may be caused by inadequate level of anaesthesia. One early sign of regurgitation is the appearance of fluid travelling up the Ambu AuraOnce airway tube. The first signs of regurgitation may be spontaneous breathing, coughing or breath-holding.

If regurgitation occurs, provided that oxygen saturation remains at acceptable levels, the Ambu AuraOnce should not be removed. This should be managed by putting the patient in a “head-down” position. Briefly disconnect the anaesthetic circuit so that the gastric contents are not forced into the lungs. Check that anaesthetic depth is adequate and deepen anaesthesia intravenously, if appropriate.

Apply suction through the mask's airway tube and through the mouth. Suction of the tracheobronchial tree using a fiberoptic through the mask may be employed if the airway reflexes are adequately obtunded.

If clinically indicated, commence preparation for immediate tracheal intubation. If aspiration has occurred, the patient should be given a chest X-ray and be treated with antibiotics, physiotherapy, and tracheal suction, as appropriate.

WARNING



If airway problems persist or ventilation is inadequate, the Ambu AuraOnce should be removed and the airway managed as clinically indicated.

7.11. Recovery

On completion of surgery, the supraglottic airway (SGA) should be removed only after the patient's protective reflexes have returned and the patient responds to verbal commands.

Patient monitoring should continue throughout the recovery stage. Oxygen should be continuously administered through the anaesthetic circuit or via a T-piece. If suction is required around the oral cavity or down the airway tube, it should be carried out prior to recovery of reflexes.

7.12. Removal procedure

Removal should always be carried out in an area where suction equipment and the facility for rapid tracheal intubation are available.

Do not fully deflate the cuff until after its removal to avoid secretions entering the larynx and to prevent laryngospasm. Alternatively, it may be removed moderately inflated to aid complete removal of secretions.

If the mask is to be removed in the Post-Anesthesia Care Unit, recovery room staff should receive thorough training in all aspects of the Ambu AuraOnce.

WARNING



The sterile Ambu AuraOnce is for single use only. Destroy after use.
Do not re-sterilise.

8. Specialized use

8.1. Intubation through the Ambu AuraOnce

It is recommended to use an exchange catheter for intubation through the Ambu AuraOnce.

A flexible fiberoptic can be used through the Ambu AuraOnce to view the airway. It is important to pre-oxygenate the patient and to use standard monitoring procedures. Fiberoptic intubation via the Ambu AuraOnce can be done using an exchange catheter.

The Ambu AuraOnce is inserted and an exchange catheter is threaded over the fiberoptic. The fiberoptic is inserted until carina is seen and the exchange catheter is "railroaded" and left in the trachea.

The Ambu AuraOnce is removed. The ET-tube is put onto the exchange catheter and "railroaded" down into the trachea. The exchange catheter is removed.

CAUTION



We do not recommend removing the airway connector on the Ambu AuraOnce.

8.2. Use of the Ambu AuraOnce for blind tracheal intubation

There is currently no published data on blind tracheal intubation through the Ambu AuraOnce. We have no clinical evidence to verify success rate and useful technique. We can therefore not recommend blind tracheal intubation through Ambu AuraOnce.

8.3. Pediatric use

The Ambu AuraOnce comes in four different sizes for infant/pediatric patients. See Table 3 for selection guidelines and maximum inflation volumes.

It is recommended that the Ambu AuraOnce in neonates and small children is used by a clinician familiar with pediatric anesthesia.

The insertion of the Ambu AuraOnce in pediatric patients can be performed in the same way as described for adults following either intravenous or gaseous induction. It is important that an adequate level of anesthesia (or unconsciousness) is achieved before insertion. The insertion should be successful at the same level of anesthesia that would be suitable for tracheal intubation. If the clinician wishes to intubate the child via the AuraOnce it is recommended that an exchange catheter is used over a fiberoptic.

Please note that with the Ambu AuraOnce, as with any form of airway management and anesthesia in pediatric patients, where ventilation is insufficient, desaturation is likely to occur faster because of the higher oxygen consumption of pediatric patients.

8.4. Critical situations and emergencies

8.4.1. Critical situations

The Ambu AuraOnce is not intended for use as a replacement for the endotracheal tube. However, in cases where tracheal intubation is not suitable or has failed, the Ambu AuraOnce may be used successfully to establish an airway.

8.4.2. Emergencies

The Ambu AuraOnce may be used during cardiopulmonary resuscitation, either as a temporary rescue airway or as a conduit to intubation. In the resuscitation situation, the patient must be profoundly unconscious with obtunded airway reflexes. The risk of regurgitation and aspiration must be balanced against the potential benefit of establishing an airway and providing oxygenation.

8.5. Magnetic Resonance Imaging (MRI)

The Ambu AuraOnce has been determined to be MRI safe and compatible. That is, when placed in a patient undergoing an MRI procedure, the Ambu AuraOnce will not present any additional risk to the patient, neither affect image quality.

WARNING



Care should be taken to monitor the patient carefully during MRI to ensure that correct positioning of the tube is maintained.

①

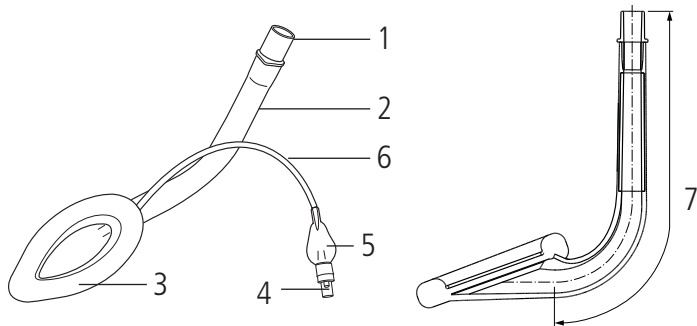

②

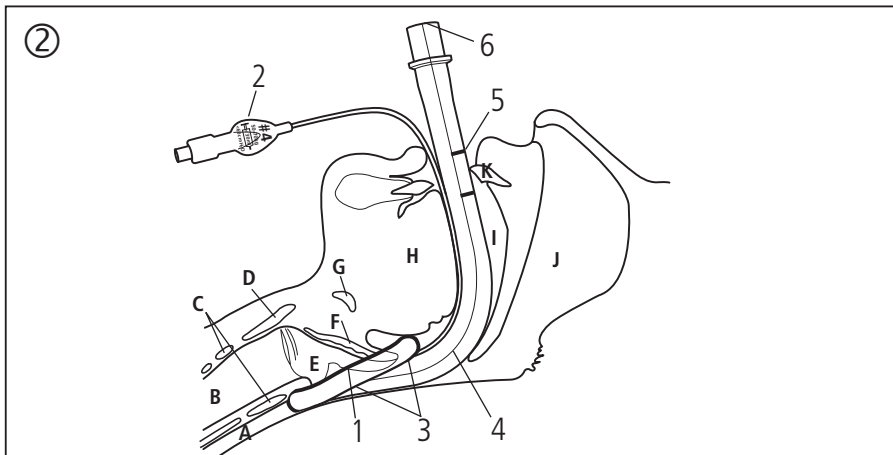

③

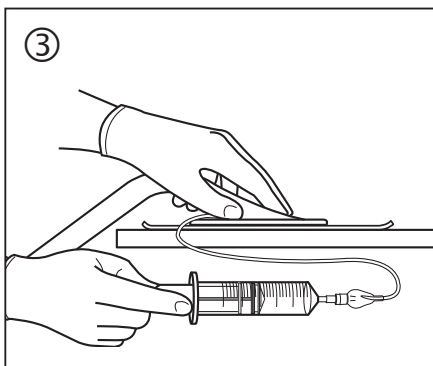

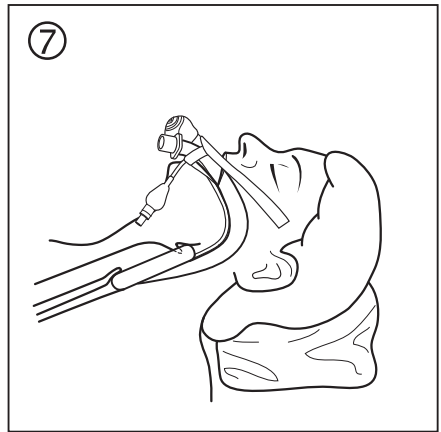
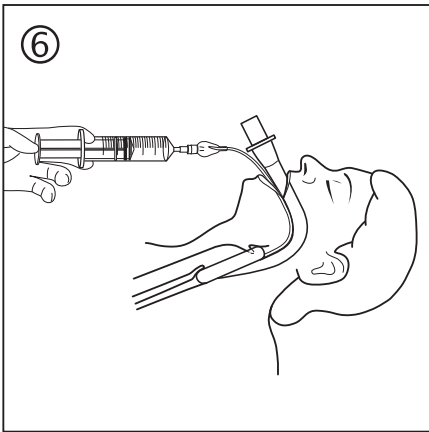
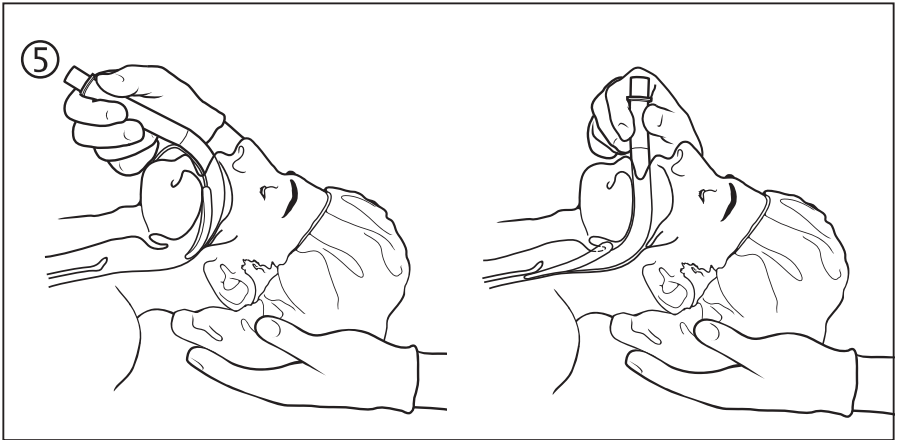
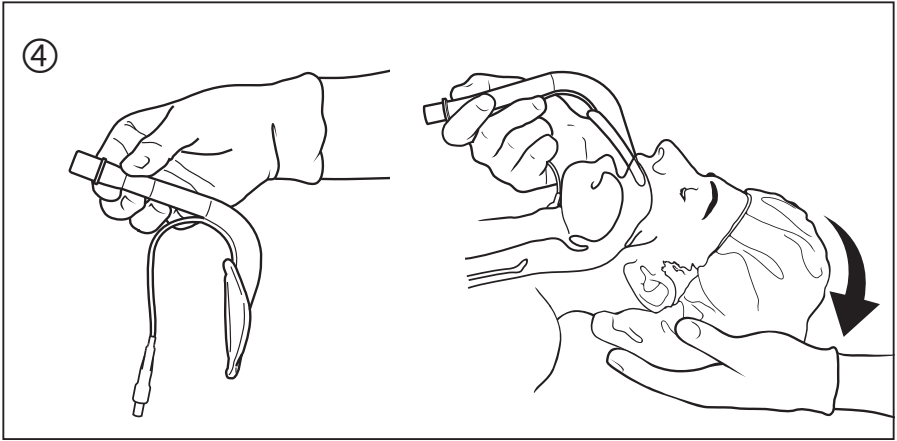



No latex. Stated when products are latex free.



Single use only



Caution, consult accompanying documents



Use by date

LOT

Traceable number

REF

Catalogue number/Catalog number

This product information may be updated without further notice.
Copies of the current version are available from the manufacturer.

© Copyright 2008 Ambu A/S, Denmark. All rights reserved.
No part of this programme or the programme documentation may be reproduced in any form,
including photocopying, without the prior written permission of the copyright owner.

**Corporate Head Office
& Manufacturer:**

Ambu A/S
Baltorpbakken 13
DK-2750 Ballerup
Denmark
Tel.: +45 7225 2000
Fax: +45 7225 2050
www.ambu.com

USA

Ambu Inc.
6740 Baymeadow Drive
Glen Burnie, MD 21060
Tel.: +1 410 768 6464
+1 800 262 8462
Fax: +1 410 760 4907
www.ambuusa.com

France

Ambu S.A.R.L.
Airspace — 6, Rue Gagarine
F-33185 Le Haillan
Tel.: +33 5 57 92 31 50
Fax: +33 5 57 92 31 59
www.ambu.fr

Germany

Ambu GmbH
In der Hub 5
D-61231 Bad Nauheim
Tel.: +49 6032 92500
Fax: +49 800 ambude
www.ambu.de

UK

Ambu Ltd.
8 Burrell Road
St. Ives
Cambridgeshire PE27 3LE
Tel.: +44 (0) 1480 498 403
Fax: +44 (0) 1480 498 405
www.ambu.co.uk

Italy

Ambu S.R.L.
Via Paracelso, 18
Centro Direzionale Colleoni
20041 Agrate Brianza - Milano
Italia
Tel.: +39 039 657811
Fax: +39 039 6898177
www.ambu.it

Spain

Firma Ambu S.L.
C/ Alcalá 261-265, Edificio 1, 3º Izq
28027 Madrid
Tel: +34 91 411 68 30
Fax: +34 91 564 50 82
www.ambu.es

Netherlands

Ambu B.V.
Edisonstraat 16j
2809 PB Gouda
Tel.: +31 0182 573293
Fax: +31 0182 531364
www.ambu.nl

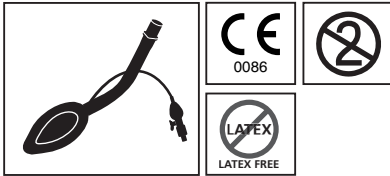

Pat. Pending



Ambu A/S
Baltorpbakken 13
DK-2750 Ballerup
Denmark
T +45 7225 2000
F +45 7225 2050
www.ambu.com