

SYRINGE PUMP OPERATING MANUAL

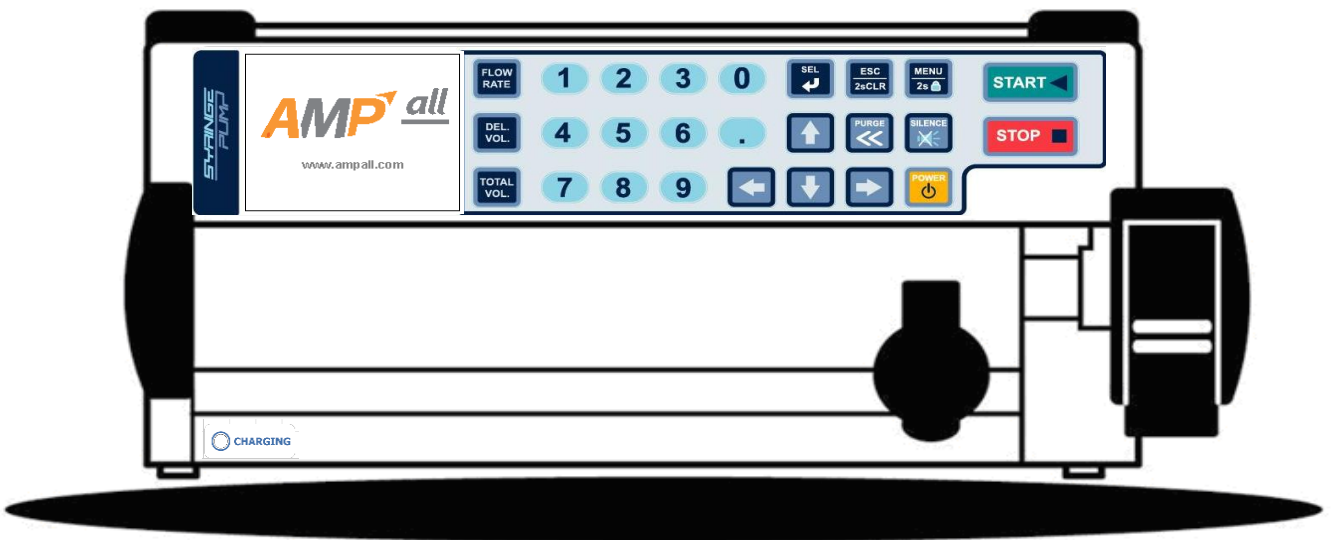

SP-8800

Thank you for purchasing our **SP-8800 Syringe Pump**.

In order to use this pump correctly and safely, read this manual carefully before operating SP-8800 Syringe Pump. If you have any questions as you are reading through this manual, call the local authorized dealer in your country. Retain this manual together with the unit for future reference.

This SP-8800 Syringe Pump is intended for the infusion of chemicals such as vasopressor drugs, depressor drugs, anti-coagulants, anesthetic drugs, anti-cancer drugs, oxytocic, nutrition, drug for chemotherapy medication and blood infusion at ICU, CCU, NICU, or operation room.

This device is designed for high flow-rate accuracy and ease of handle in the infusion of solutions with the equipped audio-visual alarms and state-of-the-art sensors.

Features

- **Self testing – Every time the unit is turned on, self testing is proceeded.**
- **Automatic syringe detection – Detect syringe size automatically. (10, 20, 30, 50ml)**
- **Shortcut key – Syringe brand set, Occlusion set, Buzzer level set**
- **K.V.O.(Keep Vein Open) – When the delivery volume has been reached, flow rate turns into K.V.O. rate (adjustable from 0.1ml/h to 10ml/h) automatically.**
- **Keypad lock function – Keypad is locked with or without password depends on its using condition.**
- **Infusion setup – Flow rate/ Delivery volume/ Infusion time**
- **Retain memory – Last setting value is retained.**
- **Infusion remaining time display**
- **Alarm repeat function**
- **Open system – Calibration up to 10 syringe brands in a single unit.**
- **Buzzer level – 3steps**
- **Occlusion level – 9steps (3.8psi~19.3psi)**
- **Purge rate – Adjustable (0.1~1200ml/h)**
- **Bolus rate – ON/OFF, Adjustable (0.1~1200ml/h, 0.1~1000ml)**
- **Anti-bolus – Reduce significantly bolus after occlusion release. (ON/OFF)**
- **History call back – Call back last 10 infusion data.**
- **Dosage mode(Body weight mode) – Automatically calculate and set a proper flow rate when dose rate, body weight, drug mass and solution volume are entered.**
- **Unit setup for Dosage mode – ml/h, mg/kg/h, mg/kg/min, μ g/kg/h, μ g/kg/min**
- **Nurse call – Each unit can be connected with nurse call system (DC 24V, 0.5A) (Option)**
- **Profile function – Program infusion condition (flow rate, delivery volume, delivery time) differently for every hour, up to 24hours. (Option)**
- **Central system – Connect with main PC for monitoring (Option)**

INTRODUCTION / FEATURES	1
1. DESCRIPTION OF SYRINGE PUMP	4
1-1.Front View	5~6
1-2.Rear View	7
1-3.Side View	7
1-4.Syringe View	8
1-5.Components	8
2. PRIOR TO PUMP USE	9
2-1.Explanation of Symbols	10
2-2.Warnings	10
2-3.Precautions	11
2-4.Cleaning & Sanitation	11
2-5.Storage	12
2-6.Maintenance & Repair	12~13
3. OPERATION	14
3-1.Initial setup	15
3-2.Syringe installation	16
3-3.Setup flow rate (ml/h)	17
3-4.Setup delivery volume (ml)	18
3-5. Confirm total infused volume (Σ ml/CLEAR).....	18
3-6.Setup delivery time (hours)	19
3-7.Insert the needle into the patient	19
3-8.Start infusion	19
3-9.Infusion completion	20
3-10.Stop infusion	21
3-11.[POWER] button	21
3-12.Battery remain	21
3-13.Error alarm	22
3-14.DC Input operation	22
3-15.Battery operation	22
3-16.Nurse call function (Option)	22
3-17.Keypad lock	23

4. SYSTEM SETUP	24
4-1. Buzzer level setup (Short-cut key)	25
4-2. Occlusion level setup	26
4-3. Syringe selection	26
4-4. Infusion set	27
4-5. Display	30
4-6. Config	31
5. SPECIAL FUNCTIONS	33
5-1. Dosage	34
5-2. History	35
5-3. Profile (Option spec)	36
5-4. Drug label (Option spec)	37
5-5. Unit setup	37
5-6. Pro. Mode	37
6. TROUBLE SHOOTING – ALARM	38~41
SPECIFICATIONS	42
SYMBOLS	43
WARRANTY	44~45



The battery may have discharged due to the delivery period. Please connect to a power socket for fully charging before the first use.

1. DESCRIPTION OF PUMP



- 1-1.Front View
- 1-2.Rear View
- 1-3.Side View
- 1-4.Syringe View
- 1-5.Components

1-1. FRONT VIEW

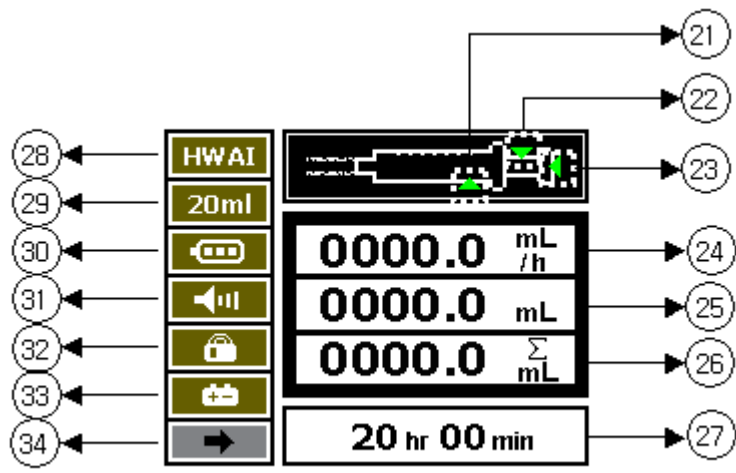
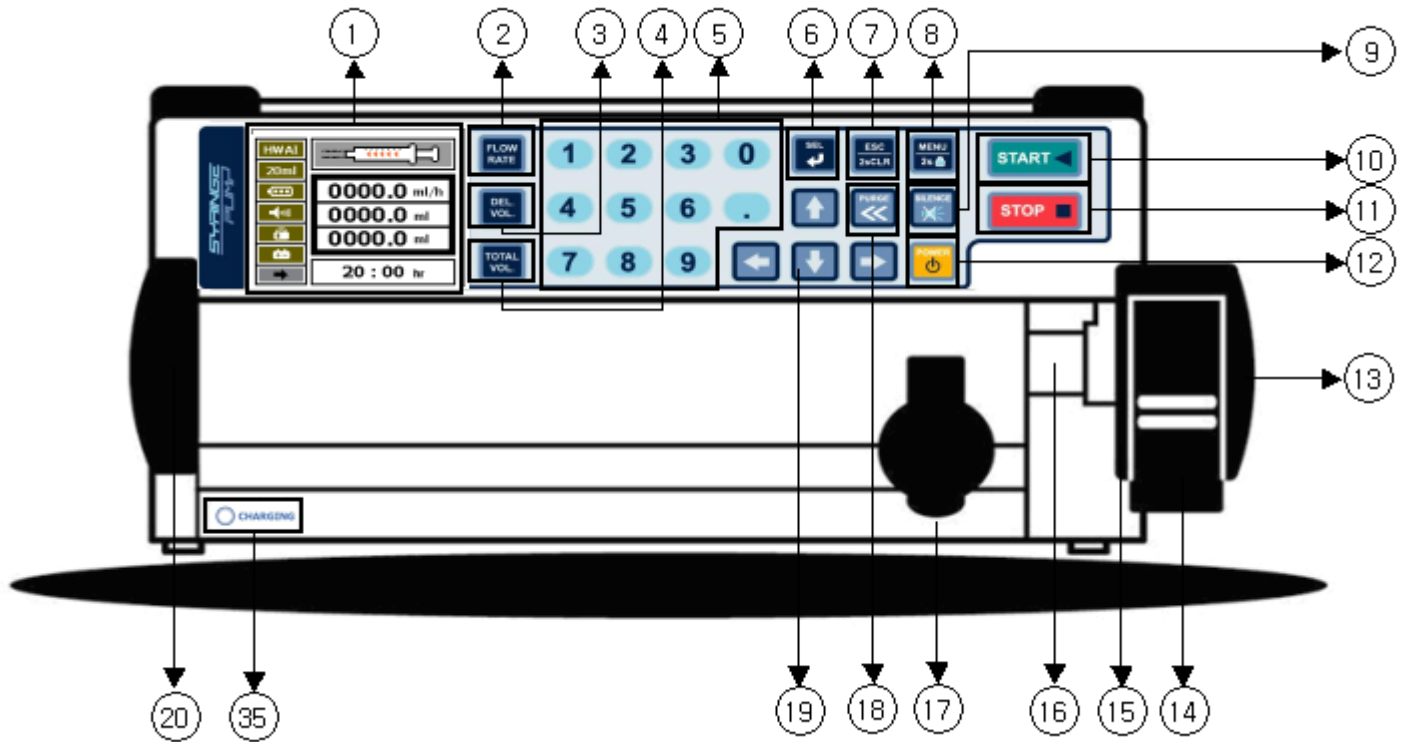

1. DESCRIPTION OF PUMP

- ① LCD : Display operating state.
- ② FLOW RATE: Set up and adjust Flow rate(ml/h)
- ③ DEL. VOL : Set up and adjust Delivery volume(ml)
- ④ TOTAL VOL: Display total infusion volume(ml)
- ⑤ NUMERICAL BUTTONS
- ⑥ SEL : Save setup value / Set up infusion time.
- ⑦ ESC/2sCLR : Move to previous state/ Delete setup value by press the button for 2seconds
- ⑧ MENU/2s  : Move to "MENU" mode/ Lock keypad by press the button for 2seconds
- ⑨ SILENCE :Hold alarm sound for 2minutes when alarm goes off. After 2minutes, alarm foes off again.
- ⑩ START
- ⑪ STOP
- ⑫ POWER : Press for 2seconds to turn on or off the unit.
- ⑬ SLIDER : Push the plunger of the syringe to infuse.
- ⑭ HANDLE LEVER
- ⑮ SLIDER CLUTCH
- ⑯ SLIT
- ⑰ CLAMP
- ⑱ PURGE - STANDBY mode : Remove air bubble in IV tube line.
- During infusion : **BOLUS** function, Bolus can be set in system menu mode.
- ⑲ DIRECTION BUTTONS
- ⑳ Line Guide : Fix extension tube.
- ㉑ Clamp State
- ㉒ Slider Clutch State : When Slider Clutch does not fix the Push Button of syringe, blinked in red.
- ㉓ Handle Lever State : When Clutch is opened(Handle Lever is up), blinked in red.
- ㉔ Display FLOW RATE
- ㉕ Display DEL VOLUME
- ㉖ Display TOTAL VOLUME
- ㉗ Display INFUSION TIME
- ㉘ Display Syringe BRAND
- ㉙ Syringe Size: 10ml , 20ml , 30ml , 50ml
- ㉚ Display state of battery
- ㉛ Display state of BUZZER level
- ㉜ Display state of lock : Lock / Unlock
- ㉝ Power supply : AC / BATTERY
- ㉞ BATTERY REMAIN : Display remaining battery operating time.
※ **Battery remaining time can be very different depends on battery condition.**
- ㉟ CHARGING : (Fully charged : Green / Charging : Orange)

1-2. REAR VIEW

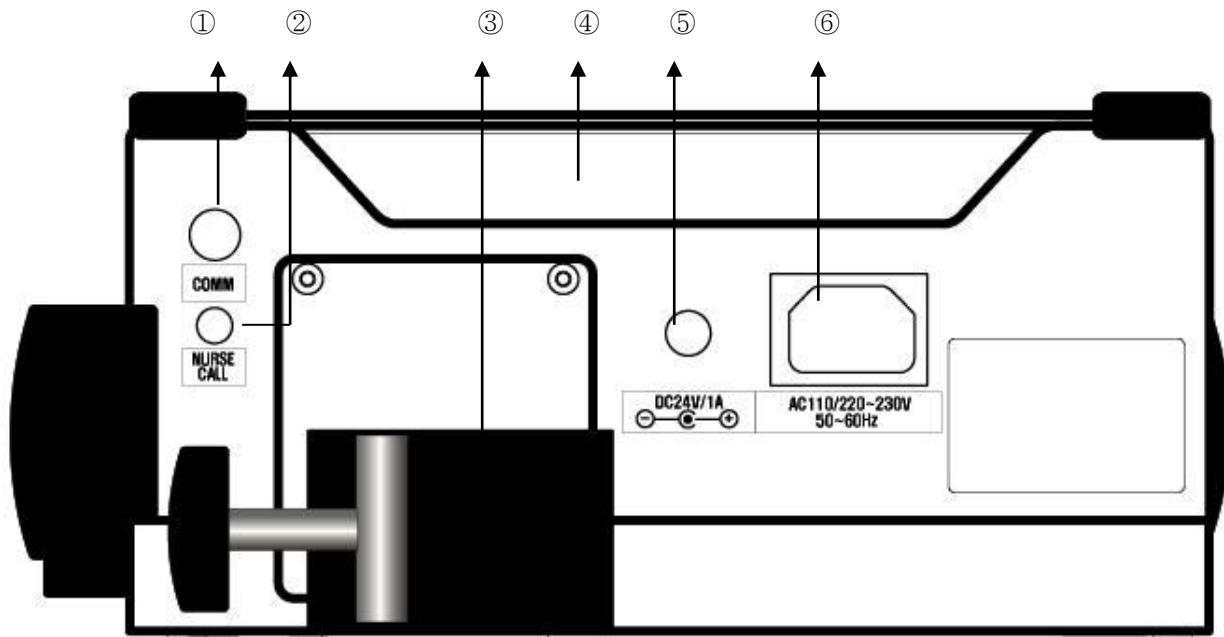

- ① Communication Connector (RS232 Connector)
- ② Nurse Call Connector (Nurse Call Connector): Connect alarm terminal cord installed in the ward.
- ③ Pole Clamp
- ④ Handle
- ⑤ DC Input Port
- ⑥ AC Power Supply Connector

1-3. SIDE VIEW

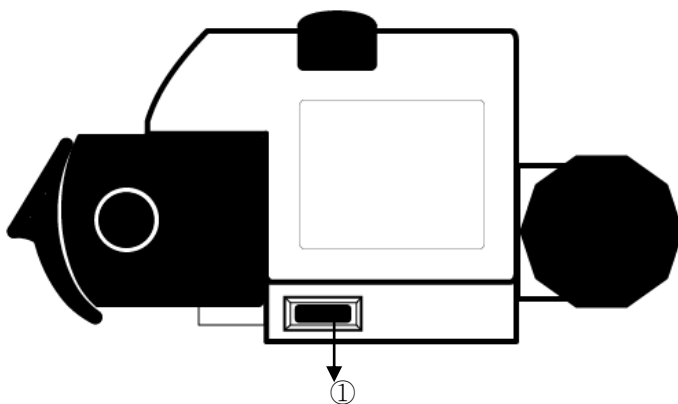

- ① Coupler: Joins two syringe pumps when one syringe pump is laid on another syringe pump

1-4. SYRINGE

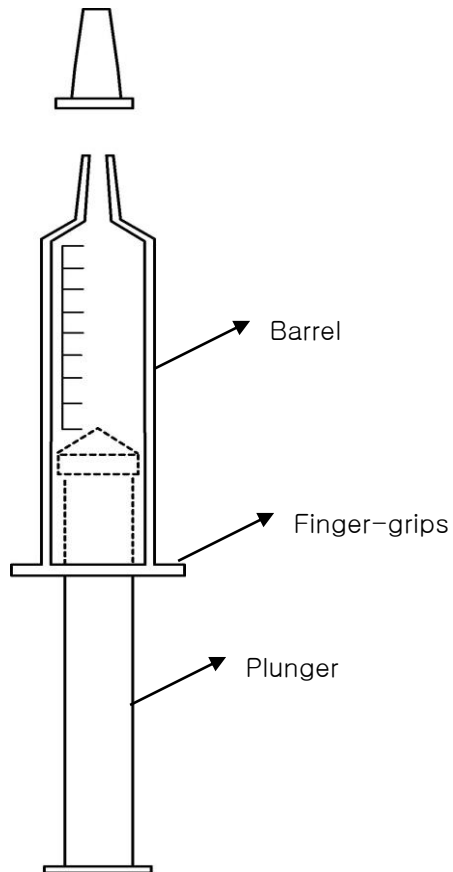

1-5. COMPONENT



AC power cord

2. PRIOR TO PUMP USE



2-1.Explanation of Symbols

2-2.Warnings

2-3.Precautions

2-4.Cleaning & Sanitation

2-5.Storage

2-6.Maintenance & Repair

2-1. EXPLANATION OF SYMBOLS



Warning is used to indicate the presence of a hazard which can cause severe personal injury, death or substantial property damage if the warning is ignored.



Caution is used to indicate the presence of a hazard which will cause minor personal injury or property damage if the warning is ignored.

NOTE

Note is used to notify the user of installation, operation or maintenance information which is important but not hazard-related.

2-2. WARNINGS

- If used in the vicinity of the surgical operation equipment which generates a high frequency current such as mobile (cellular) phone, radio, or defibrillator, the pump may malfunction since electrical interference. Please carefully check for any sources of electrical interference in the vicinity before use.
- Before using the pump, make sure that the manufacturer of the syringe to be used is the same as the one specified for this pump. If it is not matched, the flow rate accuracy and alarm system cannot be guaranteed. In order to change the syringe manufacturer, please contact your local authorized dealer.
- When using the pump concurrently with the surgical operation equipment, please note the following:
 - Do not use the pump together with any surgical operation equipment that generates high noise level.
 - Be sure that the pump is kept a sufficient distance from the surgical operation equipment.
 - The pump and such device should not be powered from the same outlet.
 - Check and confirm the normal operation of the pump periodically.
- ※ **In case of malfunction, immediately turn off the power and remove the infusion set from the patient's skin. After this action, please contact your local authorized dealer.**
- Avoid using the pump in presence of flammable gases and flammable anesthetic mixture with air, oxygen or nitrous oxide.
- The use of any mobile (cellular) phone near the pump is not allowed since the high frequency noise during the conversation could cause malfunction of the pump.
- The use of the pump in MRI rooms such as high-pressure rooms or places where high electromagnetic radiation is generated is not allowed.
- In case of using new brand of syringe other than suggested by AMPall, new brand of syringe must be calibrated by AMPall or local authorization. If not, new syringe may cause problem on infusion accuracy and alarm state.
- ※ **Please contact your local authorized dealer if you wish to use syringe that are not supported.**
- This pump does not detect 'over-infusion' or 'under-infusion'. Please check infusion state with patient regularly.
- Make sure about correct syringe installation, drug may flow backward if syringe is installed incorrect way.
- Eliminating a needle from the patient to prevent a release-bolus is required when the tube line got an occlusion.
- The pump does not detect damage to the infusion tube such as a leak in the tube or a rupture in the filter due to pressure exertion. Therefore, regularly check for any damage to the infusion line during infusion.

2. PRIOR TO PUMP USE

- When the flow is obstructed due to kinking of the tube or clogging of the needle or filter, it can increase pressure in the infusion tube and cause the tube to be inflated with the solution. Complete removal of the obstruction will allow the solution to be delivered to the patient. If the flow is obstructed, take appropriate actions.
- The syringe is disposable. Therefore, the used syringe should not be reused.
- Never modify the pump by yourself.
- The pump is connected to the AC power outlet to be operated. If there is no available AC power outlet, pump can be operated with only its internal battery. **(Alternatively, the pump may be operated by DC power).**
- The spill of the solution on the AC power inlet may cause a short circuit.
- Make sure that there is any damage with the pump and components. In case of the unit and components that were shocked, do not use them even if visible damages are not observed. Please contact your local authorized dealer.
- In case of malfunction, do not try to take the unit apart or attempt to repair by yourself. Please contact your local authorized dealer immediately. If the user does not comply with these warnings, AMPall does not take liable and the warranty does not apply.

2-3. PRECAUTIONS

- The pump does not detect about correct infusion state with blood vessel on patient. Please check the puncture site and monitor the patient's condition carefully.
- Fix the pump securely to a pole stand and check its stability. If the pump is dropped or given a hard shock, do not use it. Please contact your local authorized dealer.
- The pump must be used in accordance with this instruction manual by trained medical personnel.
- When alarm sounds, please take corrective actions.
- Do not apply a strong force or damage to the clamp or slider.



If the user does not comply with these warnings, the company is not responsible for its result and the warranty is not applied.

2-4. CLEANING & SANITATION

- Before cleaning the pump, make sure to power off the pump and disconnect the AC power cord.
- Do not immerse the pump in water.
- Do not immerse the pump in any liquid nor allow any liquid to leak into the pump.
- Do not use alcohol, thinner, benzene, ammonia, acetone or any other organic solvents.
- Do not sterilize the pump.

< Casing >

- When the pump casing is stained, use a gauze cloth or similar, moistened with cold or tepid water and let it dry, especially the AC power inlet before use. Clean AC power inlet, DC INPUT PORT, Slider hook, Clamp, Slit and Clutch regularly.
- In case of disassemble Clutch or Clamp for cleaning, contact local authorization.
- Do not use a drier to dry casing parts.

2-5. STORAGE

- Avoid the following environment for storage and transport for SP-8800 Syringe Pump.
 - Where the unit is exposed to dirt or heavy dust.
 - Where the unit is exposed to salty atmosphere.
 - Where the unit is exposed to severe vibration or corrosive GAS.
 - Where the unit is exposed to rough handling.
 - Where the unit is exposed to direct sunlight or UV light.
 - Where the unit is exposed to water.
 - Where the unit is exposed to extreme temperature and humidity.
- The optimum storage conditions for the unit
 - Temperature is between -10°C ~ 45°C.
 - Humidity is between 10% ~ 95%

2-6. MAINTENANCE & REPAIR

- If any irregularity and failure are detected, stop operation of the pump immediately and contact your local authorized dealer to repair or replace by supplying the details of the situation. Never try to disassemble or repair by yourself because it could cause further serious failure.
- Make sure that there is not any damage with the pump and components. In case that the unit and components were shocked, do not use them even if visible damages are not observed. Please contact your local authorized dealer.
- Contact your local authorized dealer for periodical inspection of the pump for safety and longer product life.
- Operate the pump with the internal battery once a month to check its performance because the internal battery is subject to aging. If the operation time is getting short after it is normally recharged, contact your local authorized dealer to replace with a new battery. Please be sure that your local authorized dealer checks it annually.
- Please recharge the internal battery fully for more than 6 hours by connecting the pump to an AC power outlet before the pump is used for the first time or after a long interval.
- If the battery is low, the pump may stop running if there is no way to connect the pump to an AC power outlet.

2. PRIOR TO PUMP USE



the product and its electronic accessories (e.g., Power cord) should not be disposed of with other household waste at the end of their working life. To prevent possible harm to the environment or human health from uncontrolled waste disposal, please separate these items from other types of waste and recycle them responsibly to promote the sustainable reuse of material resources.

3. OPERATION



- 3-1. Initial setup
- 3-2. Syringe installation
- 3-3. Setup flow rate (ml/h)
- 3-4. Setup delivery volume (ml)
- 3-5. Confirm total infused volume (Σ ml/CLEAR)
- 3-6. Setup delivery time (hours)
- 3-7. Insert the needle into the patient
- 3-8. Start infusion
- 3-9. Infusion completion
- 3-10. Stop infusion
- 3-11. [POWER] button
- 3-12. Battery remains
- 3-13. Error alarm
- 3-14. DC Input operation
- 3-15. Battery operation
- 3-16. Nurse call function (Option)
- 3-17. Keypad lock

3-1. INITIAL SETUP



3-1-1 ATTACHING THE PUMP TO THE IV POLE STAND

- Fix the pump securely on a pole stand, using the pole clamp on the back of the pump.

3-1-2 CONNECT AC POWER

- Insert AC power cord to the AC power inlet on the back side of the pump and connect the power cord to AC power outlet. Charging lamp will be on in red or green depends on its battery charging state.

(Fully charged : Green / Charging : Orange)

- After turn on the unit,
 - LCD displays  on the left side of LCD when it connected with AC power.
 - LCD displays  connected with external DC power, and  connected with battery for power supply.

NOTE

- Alternatively, the pump may be operated by DC power.

- When AC power is connected, the internal battery is automatically being recharged.

3-1-3 TURN ON THE UNIT

- Press [POWER] button for 2 seconds to turn on the unit.
 - LCD, FND and LED state lamp turn on with confirming sound and SELF TESTING is proceeded for 3seconds.
 - LCD divides left side and right side as below picture. Left side displays setup conditions, and right side displays operating state.

- * Power supply -  : AC power
-  : DC Input
-  : Battery

- Syringe brand is displayed on the left side of LCD. Please confirm syringe brand, if it is the one you are going to use with the unit.

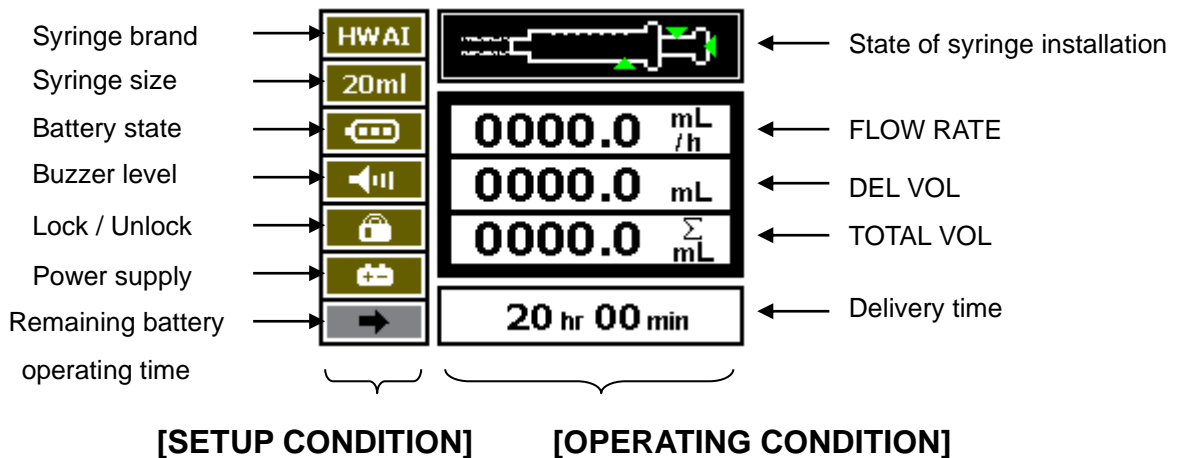

NOTE

- Please contact a local authorized dealer or agency when you have problem with the unit.

3-1-4 TURN OFF THE UNIT

- Press [POWER] button for 2 seconds on “STAND BY” mode to turn off the unit.
 - The unit is turned off after 2seconds with confirming sound and logo in LCD.
 - The unit is not turned off in “MENU” mode.

3-2. SYRINGE INSTALLATION

1. Push up the handle lever and pull at the slider to the right.
2. Pull at the clamp and turn it to the left.(Open the clamp.)
3. Install syringe filled with solution and connected with infusion tube. Fix infusion tube into the slit.
4. Pull at the clamp and turn up to close the clamp and check the syringe is fitted correctly.

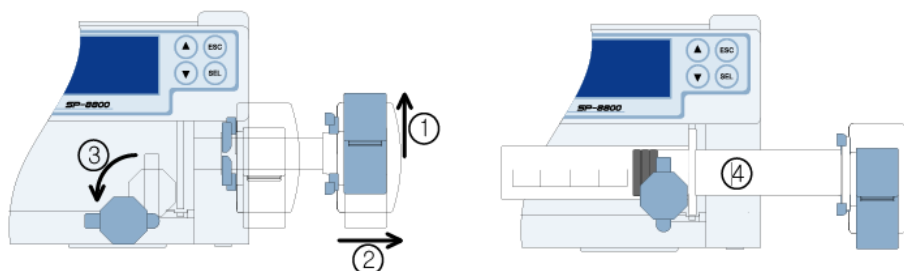

NOTE

- If the syringe is not properly placed in the slit, the flow rate accuracy and alarm system are not guaranteed.

5. After infusion tube is placed in Line Guide, push the slider slowly until it hits push-button of the syringe. When the slider hits the push-button, slider hook automatically gets down to fix the syringe. When the syringe is set in the pump, [SYRIGNE SIZE] LED lights on according to the size of syringe.
6. Press and hold [PURGE] button until a drop of solution at the end of the infusion set appears to remove air bubble in the infusion tube.

Syringe Size	Initial Purge Rate
10ml	300ml/h
20ml	400ml/h
30ml	500ml/h
50ml	1200ml/h

NOTE

- The priming volume is added to the volume delivered.
- Refer to page 25 to set up purge rate.

3-3. SETUP FLOW RATE(ml/h)

1. Press [FLOW RATE] button to get into FLOW RATE setup mode as below picture.

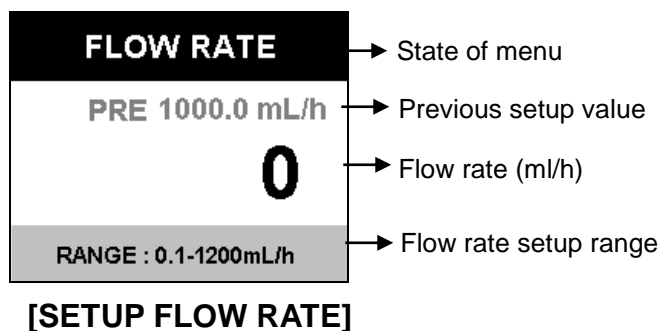

2. Input desired value for FLOW RATE(ml/h) with numerical buttons and press [SEL] button to save it. Display turns into previous display automatically.

3. Press [ESC/2s CLR] button for 2seconds to delete complete value, press  button to delete previous digit only.

4. When setup value exceeds the range, “RANGE OVER” will come up and maximum value is saved automatically. Make sure setup value before start.

Syringe size	Flow Rate
10ml	0.1ml/h ~ 300ml/h (0.1ml/h increasement)
20ml	0.1ml/h ~ 400ml/h (0.1ml/h increasement)
30ml	0.1ml/h ~ 500ml/h (0.1ml/h increasement)
50ml	0.1ml/h ~ 1200ml/h (0ml/h~999.9ml/h with 0.1ml/h increasement) (1000ml/h~1200ml/h with 1ml/hncreasement)

NOTE

- Please do not change the flow rate during the infusion.
To change the flow rate, the infusion should be stopped by pressing 'Stop' button first.
- During flow rate setup, if press [STOP] button for more than 2seconds, the value will be reset as “0000”.
- The pump does not start when the flow rate is setup at 0 ml/h. The message “NO SET” will come up on the LCD.

3-4. SETUP DELIVERY VOLUME(ml)

1. Press [DEL.VOL] button to get into DELIVERY VOLUME setup mode as below picture.

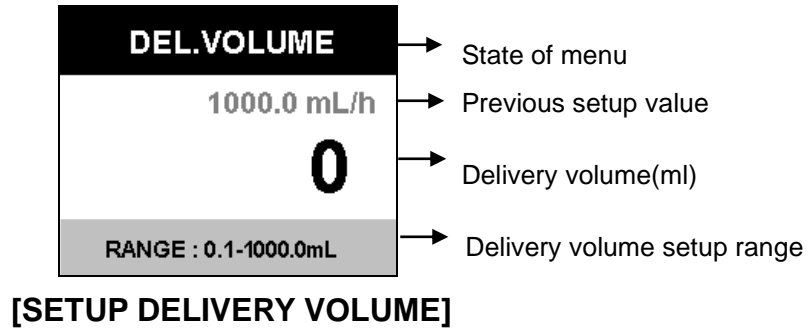

2. Delivery volume range is from 0.1 to 1000.0ml with 0.1ml increasement.

3. Press [ESC/2s CLR] button for 2seconds to delete complete value, press  button to delete previous digit only.

NOTE

- If delivery volume is set with 0ml, it is considered as maximum value, 1000ml and operates delivery volume with 1000ml.
(When remaining time is exceeded 99hours, infusion remaining time is not displayed.)
- During infusion state, delivery setup is not available. Setup is available only “STAND BY” mode.

3-5. CONFIRM TOTAL INFUSED VOLUME (Σ mL/CLEAR)

- Total volume(Σ mL/CLEAR) shows the delivered volume so far.
- Press TOTAL VOL button.
- Delete total infused volume by press [ESC / 2sCLR] button for 2seconds.

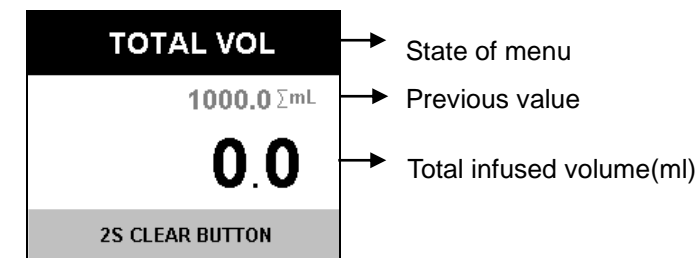

[TOTAL INFUSED VOLUME]

3-6. SETUP DELIVERY TIME(hour)

- Press [SEL] button, DELIVERY TIME on the bottom of LCD is blinked. Set up delivery time with numerical buttons and save it with [SEL] button.

NOTE

- Third value is calculated and displayed automatically when two setup values are entered among FLOW RATE, DELIVERY VOLUME, DELIVERY TIME.
- Please make sure about total infused volume when you setup infusion by time, previous total infused volume is included if it is not deleted.
- DELIVERY TIME range: 1min~99hour 59min

3-7. INSERT THE NEEDLE INTO THE PATIENT

- Insert the needle into the patient.



- Alarm does not go off when needle comes off the vein, resulting in an out-of-the-vein infusion. Therefore, regularly check the puncture site and monitor the patient's condition carefully.

3-8. START INFUSION

NOTE

- Before operating the pump, make sure to check the flow rate, delivery volume and the condition of infusion tube again.

1. Press [START] button to start infusion.



2. During infusion,  is blinked in order. "INFUSING" and DELIVERY TIME blinked by turns on the bottom line.

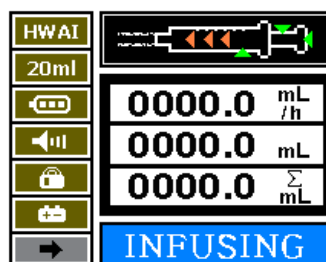

[INFUSING DISPLAY]

3-9. INFUSION COMPLETION

1. When delivery volume is reached, flow rate turns into K.V.O. rate to avoid occlusion of infusion by coagulation.
2. The unit turns into K.V.O. rate automatically, and LCD shows “CAUTION FINISH K.V.O.” as below picture with alarm sound.



[K.V.O. RATE]

3. Press [STOP] button to stop K.V.O. rate. LCD display turns into initial display.



- K.O.V. rate is adjustable, please make sure K.V.O. rate before start infusion. Otherwise over infusion may be caused.
- Over infusion may be caused by user’s setup condition, manufacturer does not take any responsibility on the problem.

4. When drug in the syringe is left about 3~4cc, “NEAR EMPTY” alarm goes off with alarm sound depends on setup flow rate. OCC alarm indicator is blinked in red.

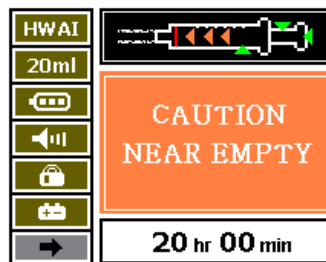

[NEAR EMPTY]

5. When the syringe is empty, “ WARNING SYRINGE OCCULUSION” alarm goes off with alarm sound and OCC alarm indicator is on red.



[SYRINGE OCCCLUSION]

6. Press [STOP] button to stop. LCD display turns into initial display.

3-10. STOP INFUSION

- Press [STOP] button to stop infusion during the operation.
- Before restart infusion, FLOW RATE, DELIVERY VOLUME and infusion tube should be confirmed. After confirming the condition, press [START] button to start infusion.

NOTE

- Allam goes off if do not restart in 2minutes after stop infusion temporally.

3-11. [POWER] BUTTON

- Power is turned on and off by press [POWER] button.
- During infusion, [POWER] button does not function.
- Press [STOP] button first to stop infusion, then press [POWER] button to turn off the unit.

NOTE

- Reset Total volume as “0” when restart infusion with new infusion condition.

3-12. BATTERY REMAIN

- Press  button in initial mode, display turns into number ③ picture and display the remaining battery operating time.

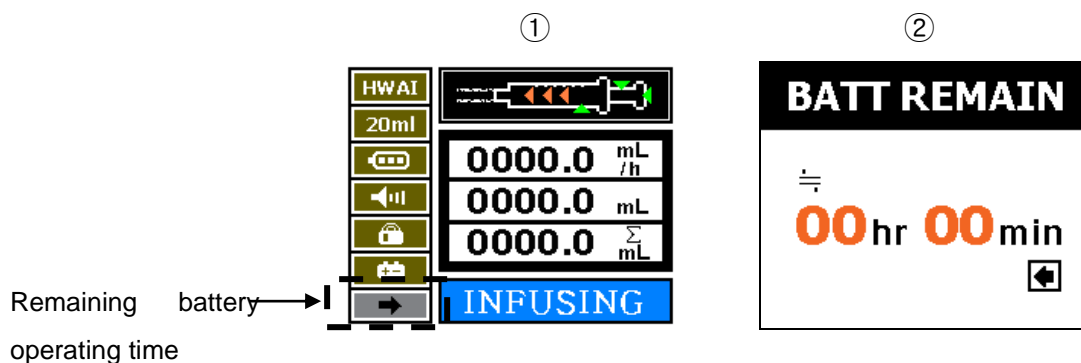

- Remaining battery operating time is different as its infusion setup condition and battery condition.
- Check about battery condition and operating condition with you refer to “BATTERY REMAIN”.
- Charging LED on the front should be green when you refer to “BATTERY REMAIN”.

3-13. ERROR ALARM

- When alarm goes off with error, press [SILENCE] button to hold alarm sound for 2seconds then settle the problem. Otherwise, alarm sound goes off again.



3-14. DC INPUT OPERATION

- This unit can be operated with DC input. DC 24V 1A, DV 12V 1A.
- Connect the DC INPUT code (Cod No.: 05LN51*) to the DC INPUT PORT and press [POWER] bottom.
- “” comes up in right side of LCD.

NOTE

- DC input cable length is up to 3m.

3-15. BATTERY OPERATION

- This unit operates with AC power supply and built-in rechargeable battery. When AC power supply is disconnected, the unit turns into battery operating mode automatically.
- Battery is charged when AC power supply is connected when ever it is on or off.
- Battery operating time is about 4 hours.
- New rechargeable battery should be charged more than 6hours.
- Battery state displays  on LCD as its remain state.
- With  battery state, if there is no AC power supply connected, the unit will be off with alarm sound and stop operation.



- Battery state should be checked every 6month to inspect battery life.
- Battery capacity may be different depends on it using condition such as fully charging and fully discharge cycle. For safety of longer battery operating time, battery should be fully charged one a month.
- If the unit has been kept without using it for more than 1months, or it is first time to use the unit, try to charge the built-in battery for more than 6hours.

3-16. NURSE CALL FUNCTION (OPTION)

- Connect nurse call connector on the back side of the unit and NURSE CALL SYSTEM built in a hospital with nurse call cord.

NOTE

- When alarm goes off, error message shows up in LCD, alarm signals are transferred to NURSE CALL SYSTEM every 5 second.
- Nurse call code number: 06LA548 *
- Nurse call cable length is up to 3m

3-17. KEYPAD LOCK

- Lock keypad by pressing MENU/2s  button.
- Keypad lock can be done with password so user can control keypad lock.
- Under Keypad LOCK, all key do not function.

NOTE

- Refer to page 28 for setup KEYPAD LOCK.

4. SYSTEM SETUP



- 4-1. Buzzer level setup (Short-cut key)
- 4-2. Occlusion level setup (Short-cut key)
- 4-3. Syringe selection
- 4-4. Infusion setup
- 4-5. Display
- 4-6. Config.

4. SYSTEM SETUP

- Press MENU button to get into Menu mode and select “SYSTEM SETUP” with [SEL] button.
- SYSTEM SETUP MENU

1. BUZZER
2. OCCLUSION
3. BRAND SET
4. INFUSION SET
5. DISPLAY
6. CONFIG

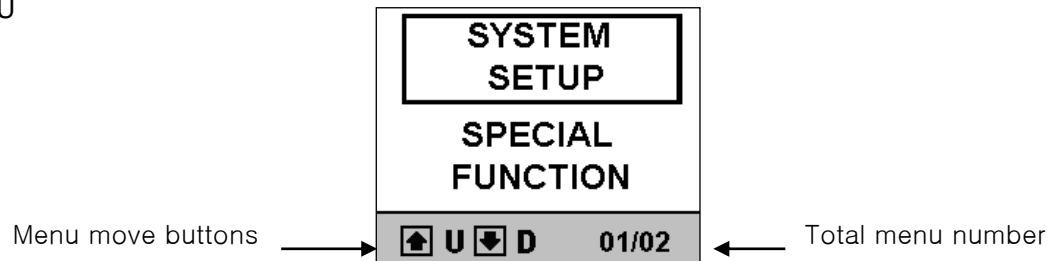

- If you do not press any button for 10seconds, LCD turns back to previous display with alarm sound.
- Press [ESC / 2sCLR] button to go back previous display. And press [SEL] button to save.

4-1. BUZZ. LEVEL SETUP (SHORT-CUT KEY)

- Get into “BUZZ. LEVEL” mode, select menu in order to MENU→SYSTEM SETUP→BUZZER.



- Adjust buzzer level with UP , DOWN buttons. There are three levels, “HIGH” , “MIDDLE” and “LOW”. Select and save with [SEL] button. After save buzzer level display turns into previous mode.



Initial BUZZ. LEVEL	HIGH
---------------------	------

- ※ Short-cut key for buzzer level: Press + [1] button in initial display.

4-2. OCC. LEVEL SETUP (SHORT-CUT KEY)

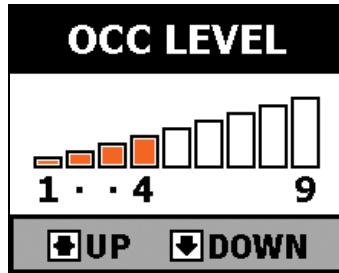
- Get into "OCC. LEVEL" mode, select menu in order to MENU→SYSTEM SETUP→OCCLUSION



- OCCLUSION is adjusted with  UP ,  DOWN buttons, it is from LEVEL 1 to LEVEL 9. Press [SEL] button to select and save. After select and save it, it turns into previous menu.

NOTE



- “H”: 800±200mmHg (106.7±26.7 kPa) or 1.09±0.27 kgf/cm²
- “M”: 500±100mmHg (66.7±13.3 kPa) or 0.68±0.14 kgf/cm²
- “L”: 300±100mmHg (40.0±13.3 kPa) or 0.41±0.14 kgf/cm²
- Initial set is LEVEL 5

- ※ Short-cut key for occlusion level: Press  + [2] button in initial display.

4-3. SYRINGE SELECTION

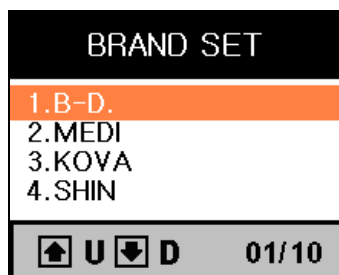
- Get into “BRAND SET” menu in order to MENU→SYSTEM SETUP→BRAND SET.



- Syringe should be calibrated by supplier, select the syringe brand will use with  UP ,  DOWN button. Select and save the syringe brand with [SEL] button. After select and save it, it turns into previous menu.

- Here is the list of basic calibration syringe brands.

(Calibrated syringe brand may be different depends on local authorized dealer.)

NO	Brand	Manufacturer
1	B - D	Beckton
2	MEDI	Medihut
3	KOVA	Korean Vaccine
4	SHIN	Shinchang
5	HWAJ	Hwajin
6	SUNG	Sungshin

NOTE

- Initial setup is "B-D".
- If you want to use other syringe brand beside the list, please contact our local authorization dealer to get confirm about calibration.



- Un calibrated syringe may occur error or accuracy problem. Please make sure the syringe brand you are using is calibrated and approved by local authorized dealer or manufacturer.
- Manufacturer or local authorized dealer do not cover the result from using syringe brand which is not calibrated or approved by manufacturer or local authorized dealer.

※ Short-cut key for syringe brand: Press  + [3] button in initial display.

4-4. INFUSION SET

There are "PURGE SETUP", "BOLUS SETUP", "KVO SETUP" in "INFUSION SET" menu.

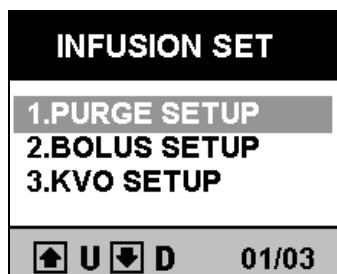

4-4-1. PURGE SET UP

- PURGE is setup from 0.1~1200ml/h.

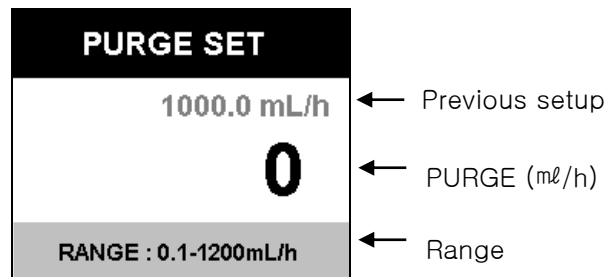

- If PURGE rate is not setup, beep sound will come out and infusion will not start.

NOTE

- Purge: To remove air in tube(line).
- Purge volume is included in total infused volume.
- Purge is working only "STAND BY" mode.





- When Purge rate is less then flow rate, Purge rate works as setup flow rate.

4-4-2. BOLUS SET

There are "BOLUS FLOWRATE" , "BOLUS D.VOLUME" for "BOLUS SET" menu.

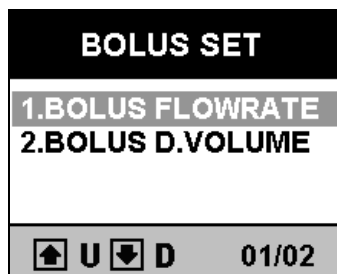
- ※ BOLUS: Infuse sure amount of solution or drug by sure infusion speed.



- BOLUS FLOWRATE SET : Setup flow rate of BOLUS with numeral buttons. Save desired value with [SEL] button. Press [ESC / 2sCLR] buttons for 2seconds to delete the total value and press  to delete previous digit in order.

- ※ Press [ESC / 2sCLR] button to move previous menu.

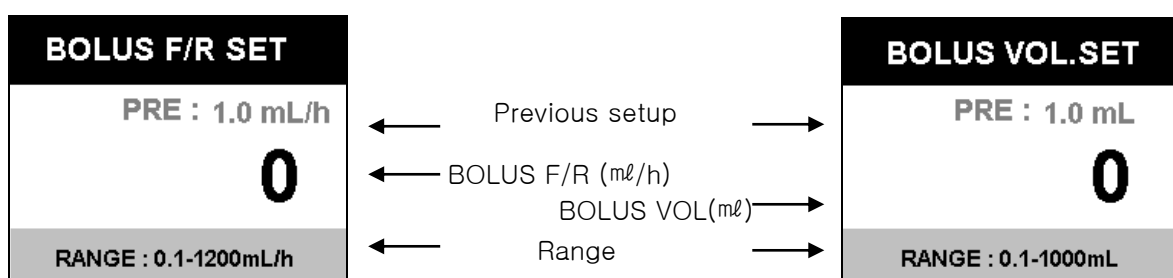

- BOLUS VOLUME : Setup total amount of BOLUS. Save desired value with [SEL] button. Press [ESC / 2sCLR] buttons for 2seconds to delete the total value and press  to delete previous digit in order.

NOTE

- BOLUS ON/OFF: Get into the menu in order to MENU→SYSTEM SETUP→6.CONFLG→BOLUS ON/OFF. You can select BOLUS ON/OFF. (Refer to page 29 for setup). (Initial setup is BOLUS OFF mode.)
- BOLUS and PURGE button is same one. It functions differently as its mode as blow.
- ※ BOLUS function: Only during the infusion



- Please make about BOLUS ON/OFF. When you do not use BOLUS function, please setup BOLUS OFF so it does not function. And make sure when you use BOLUS function about its setup condition (flow rate, delivery volume) before use it.

4-4-3. K.V.O. SETUP

Setup K.V.O. (Keep Vein Open) rate from 0.1~10.0ml/h.

※ K.V.O. (Keep Vein Open): When the delivery volume has been reached, flow rate turns into K.V.O. rate (adjustable from 0.1 ml/h to 10.0ml/h) automatically to avoid clog by blood coagulation.

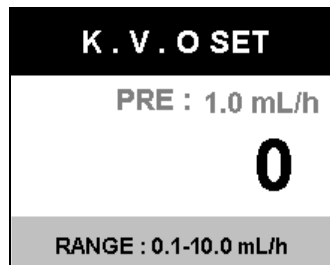

- Make sure K.V.O rate setup before use it to avoid excess infusion during K.V.O. function.
- Manufacturer does not cover the result from K.V.O. setup failure by user. So please make sure about K.V.O. setup condition before start infusion.







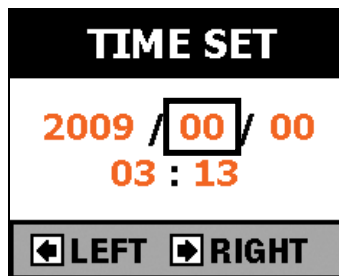

4-5. DISPLAY

There are "TIME SETUP", "B.LIGHT TIME", "B.LIGHT BRIGHT" for "DISPLAY" menu.

4-5-1. TIME SETUP

- Get into "TIME SET" menu in order to MENU→SYSTEM SETUP→DISPLAY→TIME SETUP.



- Move with , , ,  buttons and input with numerical buttons for time setup. Press [SEL] button to select and save time set.
- There is no extra delete button because you can move with , , ,  buttons at any point.

NOTE



- Once time setup, the unit keeps time whenever it turns on or off.

4-5-2. LCD BACK LIGHT TIME

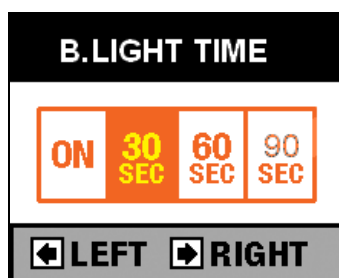
- Get into "B.LIGHT TIME" menu in order to MENU→SYSTEM SETUP→DISPLAY→B.LIGHT TIME.



- There are 4 modes for LCD black light mode.
 - ON : Always LCD black light on.
 - 30SEC : Turns off after 30seconds.
 - 60SEC : Turns off after 60seconds.
 - 90SEC : Turns off after 90seconds.

Move with ,  buttons and press [SEL] button to select and save the mode. After select and save it, it turns into previous menu.



NOTE

- Initial set is ON.

4-5-3. LCD BLACK LIGHT BRIGHT

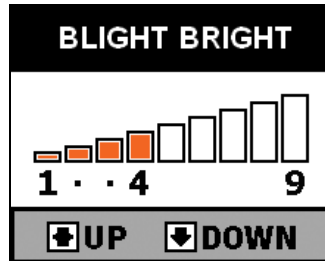
- Get into “BLIGHT BRIGHT” menu in order to MENU→SYSTEM SETUP→DISPLAY→B.LIGHT BRIGHT.



- There are brightness levels from LEVEL 1 to LEVEL 9. As level number is up, LCD goes brighter. Adjust it with ,  buttons and press [SEL] button to select and save it.

NOTE

Initial set is LEVEL 9.

4-6. CONFIG

There are “KEY LOCK P/W” , “BOLUS ON/OFF” and “ANTI-BOLUS” for CONFIG menu.

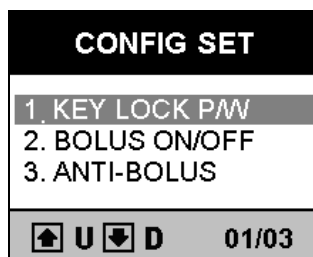



Problems from incorrect setup by user, are charged on user. It does not cover by manufacturer.

4-6-1. KEY LOCK P/W

- Get into KEYLOCK P/W menu in order to MENU→SYSTEM SETUP→CONFIG→KEYLOCK P/W.





- Move with ,  buttons, select and save with [SEL] button.

4-6-2. BOLUS ON/OFF

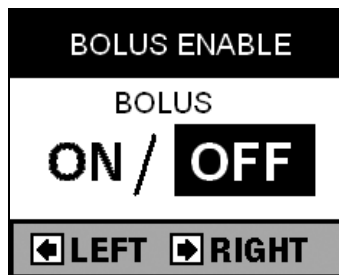
- Get into BOLUS INFUSE menu in order to MENU→SYSTEM SETUP→CONFIG→BOLUS ON/OFF.



- Move with ,  buttons, select and save with [SEL] button.

NOTE



Initial setup is OFF. (KEY LOCK P/W, BOLUS INFUSE)

4-6-3. ANTI BOLUS ON/OFF

- Get into ANTI BOLUS INFUSE menu in order to MENU→SYSTEM SETUP→CONFIG→ANTI – BOLUS.

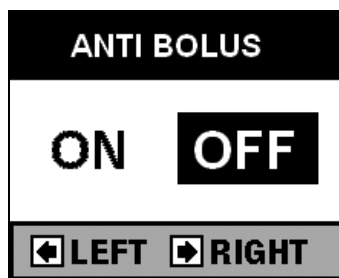
※ ANTI BOLUS: Reduce significantly bolus after occlusion release. ○



- Move with ,  buttons, select and save with [SEL] button.



NOTE

Initial setup is OFF. [KEY LOCK P/W] , [BOLUS INFUSE] , [ANTI BOLUS]

4-6-4. KEY SOUND

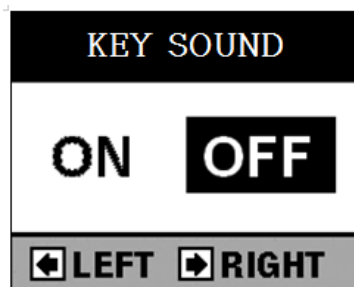
- Get into “KEY SOUND” menu in order to MENU→SYSTEM SETUP→CONFIG→KEY SOUND.



- Move with ,  buttons, select and save with [SEL] button.

NOTE

- if “KEY SOUND” is OFF, there is no sound when the buttons are pressed
- Preset is ON for KEY SOUND

5. SPECIAL FUNCTIONS



5-1. Dosage

5-2. History

5-3. Profile (Option spec)

5-4. Drug label

5-5. Unit setup

5-6. Pro. mode

5. SEPCIAL FUNCTION

- Press MENU button to get into Menu mode and select SPEICAL FUNCTION with [SEL] button.
- SPEICAL FUNCTION MENU

1. DOSAGE
2. HISTORY
3. PROFILE (OPTION SPEC)
4. DRUG.LABEL (OPTION SPEC)
5. UNIT SETUP
6. PRO.MODE

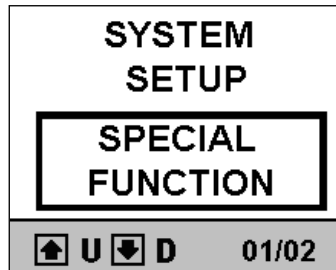

NOTE

- Contact local authorized dealer for OPTION SEPC.

5-1.DOSAGE

• DOSAGE SETUP

- Press buttons in order to MENU→SPECIAL FUNCTION→DOSAGE and there come up “DOSE RATE” on the LCD.
- DOSEGE: Automatically calculate and set the proper flow rate when the dose rate, body weight, drug mass and solution volume are entered.
- After input each parameter, press [SEL] button. Each mode is confirmed and turns into next parameter automatically. Please refer to picture No. ① to ④.
- After setup complete parameter, it turns into picture No. ⑤ automatically and display complete information for each parameter value.
- Each parameter, you can delete or change the value with [ESC / 2sCLR] or , , , buttons.
- Press [ESC / 2sCLR] button to back previous mode.

①

②

③

④



- As soon as finish input each parameter value, complete data is displayed as picture No. ⑤. Select YES to confirm the data for DOSAGE mode, it turns into STANDBY mode with confirm sound. Flow rate and Delivery volume are displayed on FND automatically. Press [START] button to start. If you select NO on the picture No.

5. SPECIAL FUNCTION

⑤, it goes back DOSE RATE mode automatically to setup each parameter again.

⑤

DOSE RATE	00.0	ug/kg /min
B-WEIGHT	000.0	kg
DRUG MASS	000.0	mg
SOL VOLUME	000.0	ml
FLOW RATE	000.0	ml
YES		NO

* Range for each parameter

Dose rate	0.01 ~ 99.99 $\mu\text{g}/\text{kg}/\text{min}$. (0.01 $\mu\text{g}/\text{kg}/\text{min}$. increment)
Body weight	0.1 ~ 300.0kg (0.1kg increment)
Solution volume	0.1 ~ 999.9ml (0.1ml increment)
Drug volume	0.1 ~ 999.9mg (0.1mg increment)

* Change unit for DOSE RATE : Unit can be changed page 36 "UNIT SET"

DOSE RATE	1. $\mu\text{g}/\text{kg}/\text{min}$
	2. $\mu\text{g}/\text{kg}/\text{hour}$
	3. $\text{mg}/\text{kg}/\text{hour}$
	4. $\text{mg}/\text{kg}/\text{min}$

NOTE

- Each parameter value should be more than "0".
- DOSAGE Mode

$$\text{Flow rate (ml/h)} = \left[\frac{\{\text{Dose rate}(\mu\text{g}/\text{kg}/\text{min.}) * \text{Body weight}(\text{kg}) * \text{Solution volume}(\text{ml})\}}{\{\text{Drug volume}(\text{mg}) * 1000\}} \right] * 60$$

5-2. HISTORY





5-2-1. Check HISTORY

- Get into HISTORY VIEW menu in order to MENU → SPECIAL FUNCTION → HISTORY.

HISTORY VIEW	
1.	09 / 07 / 14. 18:40
2.	09 / 07 / 13. 12:00
3.	09 / 07 / 12. 01:00
4.	09 / 07 / 12. 00:30
↑ U ↓ D	01/10

- HISTORY : Display last 10 infusion data, infusion starting time, infusion completing time, FLOW RATE ,

INFUSED VOLUME.

- Move with , , ,  buttons and press [SEL] button to see detail information for each data.
- HISTORY DATA: Last 10 infusion data only.

5-3. PROFILE (OPTION SPEC)

- Get into PROFILE SET menu in order to MENU → SPECIAL FUNCTION → PROFILE.

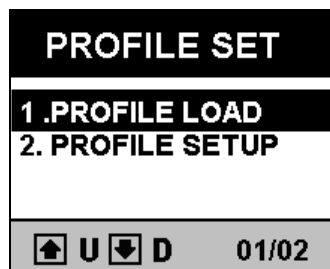

5-3-1. PROFILE LOAD

- PROFILE LOAD : Call back the previous setup data. When you select this mode, there is YES or NO selection mode to start same profile.
- Select “YES” to start same profile with previous setup. The unit turns into STAND BY mode. Press [START] button to start PROFILE, the unit start PROFILE mode with displaying “PROFILE” on LCD.
- Select “NO” to setup new PROFILE.

NOTE

- During PROFILE function, you can not setup Flow rate, Delivery volume. To stop PROFILE function, make sure PROFILE LOAD setup as “ NO”.

5-3-2. PROFILE SETUP

- PROFILE: Program infusion condition (flow rate, delivery volume, delivery time) differently for every hour, up to 24hours. (Option).
- Select “PROFILE SET UP” and press [SEL] button to get into below picture mode. Press [SEL] button to setup time for each profile, input each time with numerical buttons. Press [SEL] button to save each time and infusion setup (Flow rate, Delivery volume).
- Setup profile data up to 24hours in order to same process.
- Press [START] button to save.

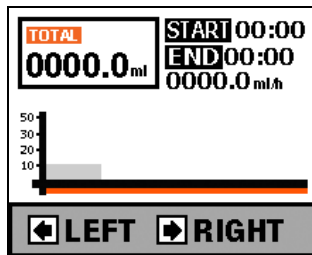

NOTE

- Time setup increment is hour only (not by minute).
- Maximum profile time is 24hour and 24 kinds of infusion setup available.
- Press up is "OFF".
- Problem occurred by user setup is charged on user. Manufacturer does not cover the problem occurred by incorrect setup or use by user.





5-4. DRUG LABEL (OPTION SPEC)

This unit does not include "DRUG LABEL" function.

5-5. UNIT SETUP

- Get into UNIT SET menu in order to MENU → SPECIAL FUNCTION → UNIT SETUP.
- This is changing the unit on DOSAGE RATE mode.



- Move with , , ,  buttons to select the unit and press [SEL] button to save it.

NOTE

- Initial setup is " $\mu\text{g}/\text{kg}/\text{min}$ ".

5-6.PRO.MODE

Contact local agency or local authorized dealer for this mode.

6. TROUBLE SHOOTING

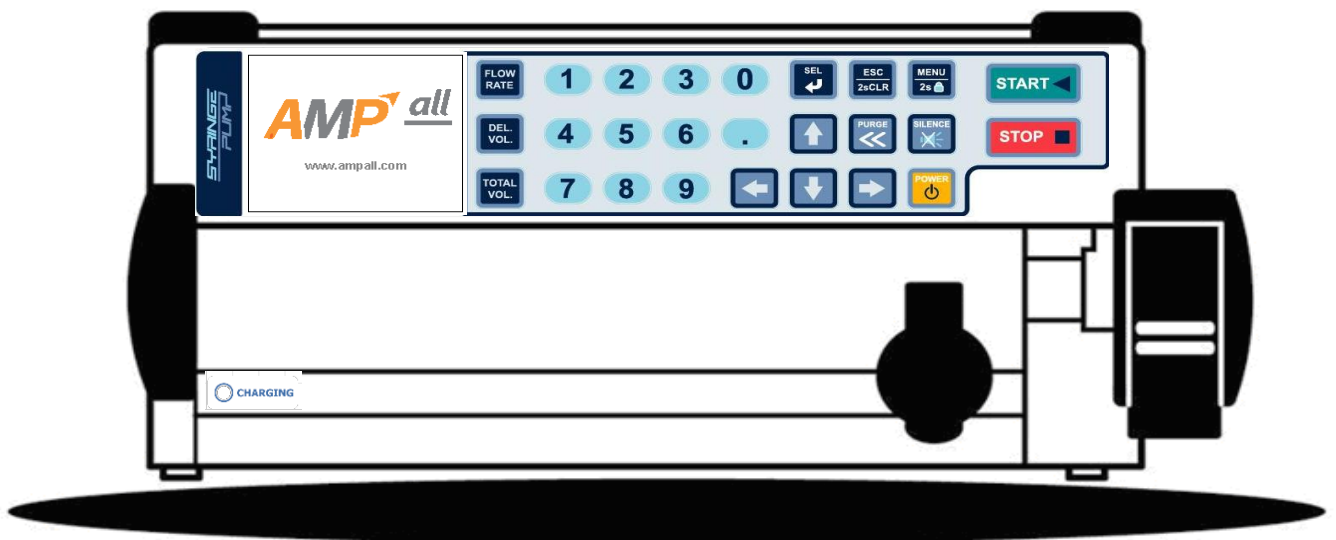



6.TROUBLE SHOOTING - ALARM

Take the following actions if any trouble occurs. When the troubles could not be solved with the following actions, please contact your local authorized dealer immediately.

NOTE

- Whenever alarm sounds, the pump stops infusion. That is, alarm sounds only in error situation during infusion.

Symptom	Cause	Action
Pump cannot be switched on.	• AC or DC power cord is not inserted properly	<ul style="list-style-type: none"> ▶ Check the AC or DC power cord connection.  <ul style="list-style-type: none"> • Never connect both AC and DC power to the pump at the same time
	• Internal battery has deteriorated	<ul style="list-style-type: none"> ▶ Stop the operation of the pump and replace with a new battery through your local authorized dealer.
	• The voltage of the internal battery is low	<ul style="list-style-type: none"> ▶ Recharge the battery fully for more than 24 hours by connecting the pump to an AC power outlet.  <ul style="list-style-type: none"> • Because of an industrial waste, used Ni-MH battery must be returned to AMPall or distributor.
[OCCLUSION] LED flashes and alarm sounds.	• The infusion line is kinked or twisted	<ul style="list-style-type: none"> ▶ 1. Turn the alarm off by pressing [SILENCE] button. ▶ 2. Check the infusion line and take a corrective action like untwisting or replacing with a new one to solve the problem of occlusion ▶ 3. Press [STOP] button to show "STAND-BY" on the LCD. ▶ 4. Restart infusion by pressing [START] button.
	• When infusion is restarted, the alarm sounds again, and the pump stops	<ul style="list-style-type: none"> ▶ The system is in trouble. ▶ Turn the alarm off by pressing [SILENCE] button. ▶ Please contact your local authorized dealer.
[FINISH] LCD display and alarm sounds	• The syringe is completely empty	<ul style="list-style-type: none"> ▶ 1. Turn the alarm off by pressing [SILENCE] button. ▶ 2. To continue the infusion, replace the syringe with a new one. ▶ 3. Press [STOP] button to show "STAND-BY" on the LCD. ▶ 4. Restart infusion by pressing [START] button.
[NEAR EMPTY] LED flashes and alarm sounds.	• The syringe is nearly empty (Finishing injection in 5 minutes before, the flash light and warning sound occurring)	<ul style="list-style-type: none"> ▶ 1. Press [STOP] button to stop infusion. ▶ 2. To continue the infusion, replace with the new syringe filled with solution. ▶ 3. Restart infusion by pressing [START] button.

6.TROUBLE SHOOTING - ALARM

Symptom	Cause	Action
[SLIDER HOOK] LED flashes and alarm sounds	<ul style="list-style-type: none"> Slider Hook does not fix Push-Button of syringe 	<ul style="list-style-type: none"> ▶ 1. Turn the alarm off by pressing [SILENCE] button. ▶ 2. Make Slider Hook fix Push-Button of syringe. ▶ 3. Press [STOP] button to show "STAND-BY" on the LCD. ▶ 4. If re-infusion is needed, restart infusion by pressing [START] button.
[CLAMP] LED flashes and alarm sounds	<ul style="list-style-type: none"> Clamp does not fix Barrel of syringe 	<ul style="list-style-type: none"> ▶ 1. Turn the alarm off by pressing [SILENCE] button. ▶ 2. Pull the clamp, turn it to the left up to 90° and put the finger grips of syringe into the slit. ▶ 3. Press [STOP] button to show "STAND-BY" on the LCD. ▶ 4. If re-infusion is needed, restart infusion by pressing [START] button.
[CLUTCH] LED flashes and alarm sounds	<ul style="list-style-type: none"> Clutch is not properly engaged 	<ul style="list-style-type: none"> ▶ 1. Turn the alarm off by pressing [SILENCE] button. ▶ 2. Make the clutch engaged properly. ▶ 3. Press [STOP] button to show "STAND-BY" on the LCD. ▶ 4. If re-infusion is needed, restart infusion by pressing [START] button.
"BATT-LOW" on the LCD and alarm sounds	<ul style="list-style-type: none"> The voltage of internal battery is low 	<ul style="list-style-type: none"> ▶ 1. Press [STOP] button to stop infusion. ▶ 2. Recharge the battery fully for 24 hours by connecting the pump to an AC power outlet. ▶ 3. Restart infusion by pressing [START] button.
"KEEP-VEIN" on the LCD and alarm sounds	<ul style="list-style-type: none"> In the operation, the total volume delivered reaches the delivery limit 	<ul style="list-style-type: none"> ▶ Stop K.V.O. rate by pressing [STOP] button
	<ul style="list-style-type: none"> The total volume delivered exceeds the delivery limit 	<ul style="list-style-type: none"> ▶ Stop K.V.O. rate by pressing [STOP] button ▶ When infusion is newly needed, set the delivery volume again or clear the total volume delivered.
When [PURGE] button is pressed, the alarm sounds.	<ul style="list-style-type: none"> The syringe is not set properly Even when the syringe is set again, purging does not occur 	<ul style="list-style-type: none"> ▶ Set the syringe correctly. ▶ The system is in trouble. Please contact your local authorized dealer
"ERROR" is on the LCD	<ul style="list-style-type: none"> The system is in trouble 	<ul style="list-style-type: none"> ▶ Please contact your local authorized dealer

6.TROUBLE SHOOTING - ALARM

Symptom	Cause	Action
Even when [START] button is pressed, the alarm sounds, and the pump does not start.	<ul style="list-style-type: none"> • The value of “flow rate, delivery limit, dose rate, body weight, drug volume, or solution volume” is not set correctly • Clutch is not properly engaged • The syringe is not set properly • The low voltage of the internal battery 	<ul style="list-style-type: none"> ▶ Confirm the values that were set. ▶ Engage the clutch correctly. ▶ Set the syringe correctly. ▶ Recharge the battery fully for more than 24 hours by connecting the pump to an AC power outlet.
[SYRINGE SIZE] LED and [CLAMP] LED flash	<ul style="list-style-type: none"> • The syringe, which is used, may be different from the one specified in the pump in terms of manufacturer • When infusion is restarted, the alarm sounds again, and the pump stops 	<ul style="list-style-type: none"> ▶ Make sure that the syringe, which is used, is the same as the one specified in the pump in terms of manufacturer. To use the syringe of different manufacturer, please contact your local authorized dealer. ▶ The system is in trouble. ▶ 1. Turn the alarm off by pressing [SILENCE] button. ▶ 2. Turn off the power. ▶ 3. Please contact your local authorized dealer for repair
The accuracy of flow rate is questionable.	<ul style="list-style-type: none"> • The syringe, which is used, may be different from the one specified in the pump in terms of manufacturer • Otherwise, the system is suspected to be in trouble 	<ul style="list-style-type: none"> ▶ Make sure that the syringe, which is used, is the same as the one specified in the pump in terms of manufacturer. To use the syringe of different manufacturer, please contact your local authorized dealer. ▶ Please contact your local authorized dealer for repair.
The operation hour by battery is too short after recharging the battery	<ul style="list-style-type: none"> • Internal battery has deteriorated • Otherwise, the system is suspected to be in trouble 	<ul style="list-style-type: none"> ▶ Stop the operation of the pump and replace with a new battery through your local authorized dealer. ▶ Please contact your local authorized dealer for repair.
Battery is not recharged even when it is connected to AC power outlet.	<ul style="list-style-type: none"> • AC power cord is not inserted properly • AC power cord has deteriorated • Otherwise, the system is suspected to be in trouble 	<ul style="list-style-type: none"> ▶ Check the AC power cord connection. ▶ Replace with a new AC power cord. ▶ Please contact your local authorized dealer for repair.
Battery is not recharged even when it is connected to DC power outlet.	<ul style="list-style-type: none"> • DC power cord is not inserted properly • DC power cord has deteriorated • Otherwise, the system is suspected to be in trouble 	<ul style="list-style-type: none"> ▶ Check the DC power cord connection. ▶ Replace with a new DC power cord. ▶ Please contact your local authorized dealer for repair.

SPECIFICATION

DELIVERY PERFORMANCE

FLOW RATE RANGE	Syringe 10ml: 0~300ml/h Syringe 20ml: 0~400ml/h Syringe 30ml: 0~500ml/h Syringe 50ml: 0~1200ml/h
VOLUME LIMIT	0.1~1000ml (0.1ml steps)
PURGE RATE	0.1~1200ml/h (Adjustable)
K.V.O. RATE	0.1~10ml/h (Adjustable)
ACCURACY WITH APPROVED SYRINGES	Mechanical accuracy: ±2% Accuracy including syringe: ±2%

ALARM

OCCLUSION, NEAR EMPTY, LOW BATTERY, K.V.O. RATE, CLUTCH OPEN, SLIDER HOOK OPEN, CLAMP OPEN, REPEAT ALARM, STAND BY

FEATURES





CLASSIFICATIONS	Class I , CF, IPX3
OCCLUSION DETECTION PRESSURE	1.3kgf/cm ²
NURSE CALL	DC12V, 1A, The Cable length is up to 3m
KEYPAD LOCK, SHORT-CUT KEY, HISTORY CALL-BACK, RETAIN MEMORY, REMAINNING TIME, OPEN SYSTEM, PURGE, BOLUS, K.V.O., BUZZER VOLUME / OCCLUSION PRESSURE CONTROL, DOSAGE MODE, NURSE CALL(OPTION), DRUG LABEL(OPTION), PROFILE(OPRION), CENTRALL SYSTEM(OPTION)	







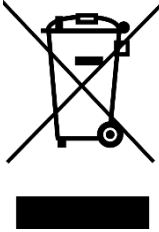
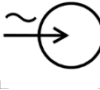
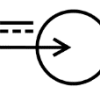
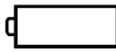

OTHER PARAMETERS

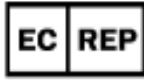

POWER REQUIREMENTS / CONSUMPTION	AC100 / 240V, 50 / 60Hz or DC9.7V, DC12V 1A / 45VA The DC Input cable length is up to 3m.
DIMENSIONS (W × D × H)	220×130×108 (mm)
WEIGHT	Approximately 2kg
BATTERY / OPERATION / CHARGING	Ni-MH9.7V / 4 hours / 6 hours
BATTERY LIFE	1.5~2 years
OPERATION CONDITIONS	5~40℃, 30~90% RH (no condensation)
STORAGE CONDITIONS	-20~45℃, 10~95% RH (no condensation)
WARRANTY PERIOD	1 year
Expected Service Life	5 years

※ Specifications and design are subject to change for improvement without prior notice

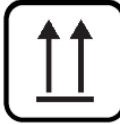
SYMBOL

Meaning	Symbol
Description	Symbol
CE Marking of conformity	
Model Number.	
Type CF applied part	
Classification Class I	
Medical Device	
The product should be recycled separately from household waste. When this product reaches its end of life, follow the local laws and regulations of disposal. The improper disposal of waste electronic equipment from the consumer may be subject to fines.	
Rated power input, A.C.	
Rated power input, D.C.	
Battery, general	

Manufacture information	
Manufacturing Date and year	
Serial Number	
Manufacturer ' s EU representative information	
Refer to instructions for use	
Keep dry	
Fragile	
This way up	
Use no hooks	
To indicate that transport package shall not be exposed to sunlight.	

<p>Indicates the temperature limits to which the medical device can be safely exposed.</p>	
<p>Indicates the range of humidity to which the medical device can be safely exposed.</p>	
<p>Indicates the range of atmospheric pressure to which the medical device can be safely exposed.</p>	

AMPall warrants that the product shall be free from defects in workmanship and materials for the warranty period. The warranty is void if failure of the product has resulted from accident, alteration, abuse or misapplication to include unauthorized opening of the product.

Under the warranty, AMPall shall repair or replace at its option and expense any products found defective by the customer during the warranty period and returned to an authorized AMPall representative.

Return of the repaired or replaced product to the customer's original location shall be at the expense of AMPall unless AMPall determines that the products are not defective within the terms of the warranty.

In such case the customer shall pay AMPall all costs of handling, transportation and labor.

This warranty is in lieu of all other warranties whether expressed or implied.

• Manufacturer : AMPall Co.,Ltd.

3F, Annex Hankook Junja Hyeopdong B/D (Gasam-Dong)

114 Gasam digital 2-ro, Geumcheon-gu, Seoul, 08506, Korea

TEL: 82-2-858-2839~41

FAX: 82-2-858-2442

E-mail: ampall@ampall.com

• EC Representative : AR Experts B.V.

Amerlandseweg 7

3621 ZC Breukelen, The Netherlands

TEL: +31 (0)88 995 1333

E-mail: info@ar-experts.eu

Warranty Card

Thank you for your purchasing for AMPall product. The warranty period Of SP-8800 is valid from the purchasing date. Please notice the purchasing date on the warranty card and keep this Warranty Card with the device all the time to get full customer service.

Product Name	Infusion Pump
Model Name	<input type="checkbox"/> SP-8800
Manufacturing Date	
Warranty Period	1 years

Purchasing Date	/ / (year/ month/ date)	
Customer	Name:	Tel.:
	Add.:	
Retailer	Name:	Tel.:
	Add.:	

Repairing Record

Date	Contents of Repair	Confirmation

☆ Please show this Warranty Card when you request repairing service.

3F. Annex Hankook Junja Hyeopdong B/D,
114, Gasan digital 2-ro, Geumcheon-gu, Seoul, Korea.
TEL : +82 - 2 - 858 - 2839~41 / FAX : +82 - 2 - 858 - 2442
E-mail : ampall@ampall.com / Website: www.ampall.com