

# USAGE INSTRUCTIONS

## **COMPACT**

**multipurpose trolley**

**A<sup>®</sup> AURION**

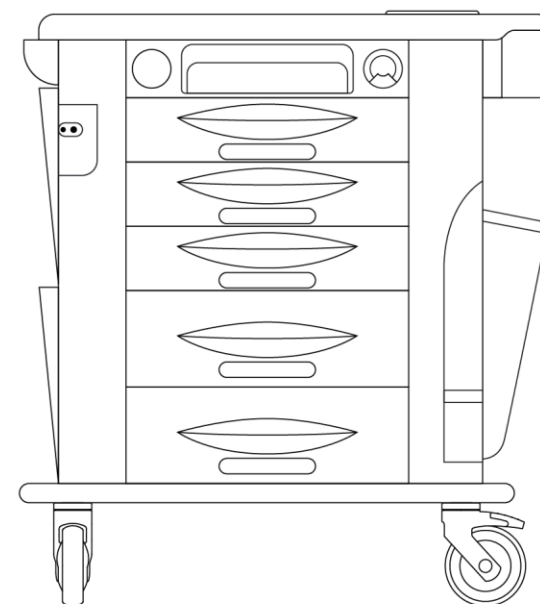

**GAMMA**  
POLIURETANI

**MD**

CLASS I

**CE**

Copyright © 2014 GAMMA POLIURETANI S.R.L. All rights reserved.

## IMPORTANT

Verify immediately the package content (pag. IN 11)

Reproducing, transmitting or saving the following information, or part of them, into an information search system, as well as translating them, or part of them, into any language and in any form, is strictly forbidden, unless a written authorization is given by GAMMA POLIURETANI S.R.L. (from now on we will refer to it simply as GAMMA).

GAMMA decline responsibility for damages deriving from an improper use of the trolley. It is therefore strongly advisable to read the present manual for a correct use of **COMPACT trolley**.

GAMMA reserve the right to modify the technical/functional specifications and characteristics of subsequent versions of this product at any time, without warning.

**Instructions for use are an integral part of the trolley and therefore they must be kept with it, so that they are always available for consultation. The present document must follow the trolley's lifecycle, even when it is transferred to other users.**

Requests for technical information or for other copies of this document are to be addressed to



**GAMMA POLIURETANI S.R.L.**

**Via Padova 9.**

**31046 Oderzo (TV) - ITALY**

Always remember to quote the serial number printed on the plate (pag. IN 6)

Responsible or authorised representative of the manufacturer:

GAMMA POLIURETANI S.R.L.

Number and year of manufacture: see identification plate on the trolley

Identification code of the present document: 66990020

Revision: 01.00

Printing finished on: 03/2022

## INDEX

INFORMATION.....	IN 1	CONTAINERS (ACCESSORIES).....	CO 1
General information .....	IN 4	Front drawers.....	CO 2
Identification of COMPACT and of its components .....	IN 6	Dividers .....	CO 3
Safety .....	IN 7	Wirebaskets .....	CO 4
Environmental conditions.....	IN 10	Trays .....	CO 5
Trasportation and installation.....	IN 10	Dispenser.....	CO 6
Before use.....	IN 11	Stainless steel shelves .....	CO 7
Safe usage.....	IN 12	Basins .....	CO 8
Maintenance .....	IN 12	Doors with seal lock.....	CO 9
Long periods of non-usage .....	IN 13	SUPPORTS (ACCESSORIES).....	SU 1
“Exceptional” transportation.....	IN 13	I.V. pole.....	SU 2
De-commissioning and disposal .....	IN 14	Telescopic I.V. pole .....	SU 3
BODY .....	BO 1	Holding frame .....	SU 4
Single piece body .....	BO 2	Holding bar.....	SU 6
Top surface .....	BO 2	Basin holding frame .....	SU 7
Needle tub.....	BO 2	Tub holder.....	SU 9
Sliding top surface .....	BO 3	Shelf for suction pump .....	SU 10
Drawer with stainless steel tray .....	BO 3	Oxygen bottle holder (SMALL or LARGE).....	SU 11
Transparent swinging pockets .....	BO 4	Rotating instrument carrying tray .....	SU 13
Pocket catheter holder .....	BO 4	Lockable rotating instrument carrying tray.....	SU 15
Hooks.....	BO 4	Cardiac massage board.....	SU 17
Oxygen bottle holder.....	BO 5	Perimetral protection.....	SU 19
Life-saving medicines drawer .....	BO 5	Paediatric mattress .....	SU 20
Waste bin with lid.....	BO 6	DEVICES (ACCESSORIES).....	DE 1
Water bottle holder .....	BO 6	Multiple power outlet.....	DE 2
Central locking system.....	BO 6		
Front opening space .....	BO 8		
Ampoule opener .....	BO 8		
Wheels / braking system.....	BO 9		

# INFORMATION

This chapter contains all necessary information for both a correct and exhaustive knowledge of all technical features and general functioning of **COMPACT**, and the correct consultation of the present manual.

In order to avoid confusion and potential errors on the part of readers, all information referring to specific components (containers, supports and devices) which might not be present in your trolley (because they are accessories), are reported in the corresponding sections (CONTAINERS, SUPPORTS AND DEVICES).

#### Note:

According to the CE declaration of conformity (supplied together with the trolley) the manufacturer or his authorized representative in the Community declares and guarantees that this product complies with the applicable provisions contained in the directive.

Documents referring to components supplied by third parties and the various annexes (necessary for a better understanding of the trolley for maintenance) are to be found inside the package.

## CERTIFICATE OF GUARANTEE – PLEASE FILL OUT AND SEND A COPY

SENDER

COMPANY NAME: .....

ADDRESS: .....

TOWN: .....POSTCODE: .....

NATION: .....

DATE OF PURCHASE: ...../...../.....

TYPE: AURION COMPACT

SERIAL NUMBER: .....

## **GAMMA POLIURETANI S.R.L. GUARANTEE CONDITIONS FOR A PERIOD OF 24 MONTHS**

1. This guarantee certificate must be kept until its expiry date and must be produced every time technical service under guarantee is needed. Users who are not able to produce this document, will lose all guarantee rights. The guarantee starts on the date of delivery of the trolley, and is valid for 24 months.
2. During this period GAMMA guarantee the quality of materials and the sound construction of each trolley. The components of the appliance that in GAMMA's undisputable opinion are faulty because of material or manufacturing fault, will be substituted free of charge at the user's premises by staff from the nearest assistance centre.
3. The guarantee will be valid only if a copy of the original invoice issued to the Customer is produced and the guarantee certificate is sent to GAMMA, complete with the following data:
  - buyer's name;
  - model and registration number of the product;
  - date of purchase.

GAMMA reserve the right to refuse acknowledgement of the guarantee should these data have been removed or tampered with after purchasing.

4. The following are not covered by guarantee:
  - 4.1 damages (scratches, dents and similar) caused by carelessness, negligence, tampering, incompetent use, or repairs carried out by unauthorized staff;
  - 4.2 damages due to incorrect installation of the appliance and of the accessories, or to faults caused by insufficient or unsuitable electrical installation, or alterations due to weather or environmental conditions or conditions of any other nature;
  - 4.3 light bulbs, glass components, knobs, rubber seals;
  - 4.4 installation advice and comfort checks;
  - 4.5 general maintenance;
  - 4.6 what can be considered normal wear and tear.
5. GAMMA decline any responsibility for damages which may be directly or indirectly caused to things or people due to the lack of compliance with all prescriptions indicated in the special "instructions" regarding assembly.
6. GAMMA will not be liable for any damages caused to people or things or by breakdowns or forced interruption of use of the appliance. The parts that are substituted under guarantee will remain the property of GAMMA.

## General information

### Foreword

A new generation of hospital trolleys is born, fruit of innovative thinking (an innovative and sophisticated material like Bayer's Baydur® was used) and of a detailed design: **COMPACT**.

**COMPACT** is specialised. The new system is designed to offer as many opportunities as possible for customisation. Although different versions are already available for specific hospital needs, there are further diversification opportunities thanks to an extremely wide range of components and accessories.

**COMPACT** is beautiful. Its elegant shape, the absence of corners, its well harmonised colours and the Italian style make it a working tool both useful and pleasant to the eye.

**The multipurpose trolley you bought does cause particular risks for operators, provided all prescriptions contained in this document are observed. Therefore, for a correct and safe use of COMPACT it is necessary to read all chapters of this manual (except those relative to accessories you are not supplied with) with particular attention to chapter "Safety" on page IN 7.**

### Intended use

**COMPACT** is a medical device to be used solely as a support in giving assistance to patients in hospital wards or in surgeries.

**COMPACT** can be used as a means of storing and transporting drugs, medications, consumables, specialist medical equipment and clinical records, depending on the accessories installed on it and on the maximum allowable loading weight of the various components (according to the indications contained in the sections concerning the various accessories - starting from pag. CO 1)

### ATTENTION:

This device is addressed to properly trained staff. Using **COMPACT** is forbidden for untrained staff. **COMPACT** must not be used improperly, i.e. for uses that are different from its intended use.

### Contraindications

**All uses that do not correspond with the indications contained in the previous paragraph ("Intended use") are not to be considered as possible uses of the GAMMA COMPACT trolley.**

**GAMMA do not guarantee safety of users, patients or third persons, if the trolley is used for different purposes.**

### User's responsibility

If the instructions on assembly, use and maintenance of the trolley contained in this manual are disregarded, GAMMA decline any responsibility. GAMMA accepts no responsibility for damages incurred to or caused by the trolley, due to:

- improper use of the trolley or use by untrained staff;
- use in contravention to specified National Standards;
- incorrect assembly;
- disregard for safety and personal protection;
- serious lack of periodic maintenance;
- incorrect preparation of the workplace or structure where the trolley is going to be used;
- unauthorised modifications or servicing;
- use of spare parts of different manufacture;
- failure of the main power supply;
- use of an incorrect power supply.

## How to read this manual

The function of the present manual is to inform and guide users in the assembly, use and maintenance of **COMPACT** and of its accessories.

Since the natural adaptability of **COMPACT** to customisation (in compliance with the indications contained in the present document) make it impossible to supply a specific document for each variant, the following “compromise” has been reached.

This manual was developed and subdivided into **six different sections** (the first three are common to all trolley types, whereas the last three contain the accessories cards<sup>(\*)</sup>), identified by the icons placed in the lower part of each page (and by the specific page number). This manual is available in four different languages (indicated by the icons on the right).

This layout optimises navigation inside the manual, making the manual a dedicated document, which is easy to consult.

**Texts that are highlighted by the following drawing:**



**must be read very carefully. In fact, if the instruction contained in these texts are disregarded, the safety of persons and of the trolley could be jeopardized .**

(\*) a card is composed of one or several sheets of paper containing the instructions referring to each accessory that can or has actually been installed in order to integrate the BODY of COMPACT. Cards are grouped in “families” of accessories: containers, supports and devices.

## Who should read the manual

The present document is addressed to all users of the trolley.

## Glossary

Term	Meaning
Medical accessory.	Product which is not a device, but was specifically designed to be used with a device, in order to use it as was intended by the manufacturer.
Patient.	Person who is subjected to medical care, tests and the like.
Residual risks.	Risks that prove not to be eliminable during design and manufacture. The indications contained in this document, on the plate and on the trolley itself are meant to “compensate” for these risks.
Third persons	All persons (other than patients, users or doctors) who may have something to do with the trolley.
User	Who uses the medical device (doctors, paramedical staff and, in general, users different from patients).



## Identification of COMPACT and of its components

Once the trolley has been unpacked (pag. IN 10), it can be identified thanks to the special plate.

### ATTENTION:

Do not remove the plate.

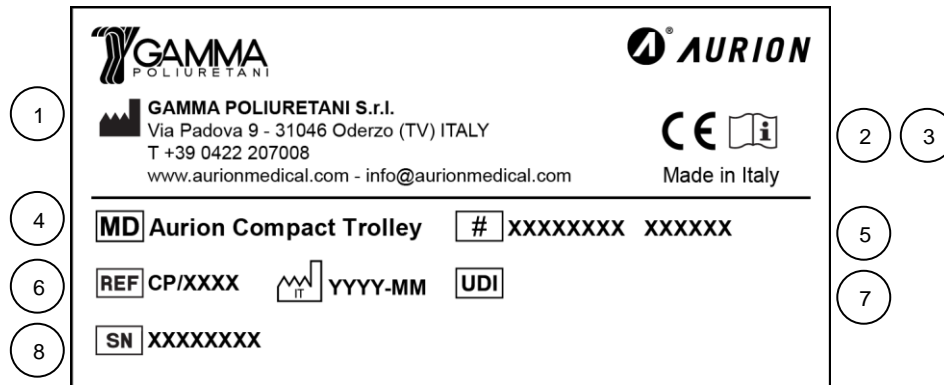

- 1) Manufacturer
- 2) Device in compliance with EU Regulation 2017/745
- 3) See the user manual
- 4) Medical device
- 5) Product number
- 6) Product code
- 7) Date of manufacture
- 8) Unique Device Identification
- 9) Serial number

This plate contains all essential information about the trolley.  
In order to identify the accessories that have been supplied together with the trolley you bought, it is necessary to refer to the transport document.

## The COMPACT “family”

Starting from a standard body, **COMPACT** is designed to be customised with a wide range of accessories (which are the distinguishing features of the various versions), according to the specific needs of each hospital ward.

For this reason, your **COMPACT** is composed of a standard BODY - which is the same for all trolleys – on which some accessories are then assembled by GAMMA or by yourself.

## Standard components (standard body)

As far as the description of standards components is concerned, refer to the layout on page BO 1 and following.

## “Accessory” components

Accessories have been divided by function:

- CONTAINERS (layout and description starting from pag. CO 1);
- SUPPORTS (layout and description starting from pag. SU 1);
- DEVICES (layout and description starting from pag. DE 1).

**Note: obviously it is not possible to assemble all available accessories on one single trolley! For additional information contact GAMMA.**

### ATTENTION:

**Assembly and disassembly of all accessories are to be carried out when power supply (if present) is disconnected from the trolley.**

**It is forbidden to use accessories that are not supplied by GAMMA.**

**Environmental conditions for the use of accessories are reported on pag. IN 10.**

**For a correct and safe use of accessories with COMPACT it is necessary to read carefully the text contained in sections “INFORMATION” (from pag. IN 1) and “BODY” (from pag. BO-1) of the usage instructions of the trolley.**

## Safety

### Guarantees about safety and hygiene

If COMPACT is used properly and according to the instructions supplied by GAMMA, it will not cause hazards for operators. GAMMA decline responsibility for any damages which may be caused to persons or things due to an improper use of the trolley.

Using spare parts different from those supplied by the manufacturer may cause damages to people or to the trolley.

- **COMPACT** is safe. It is in line with the highest safety standards thanks to the materials used, to its rounded shape, to the absence of sharp metal parts and to the attention paid to the fitting of all the accessories.
- **COMPACT** is innovative. It was manufactured with state-of-the-art materials, such as rigid polyurethane Baydur ®, which is unchangeable with time, resistant to chemical agents, not subject to corrosion and auto extinguishing.
- The solutions adopted for the design and manufacture of the trolley comply with all safety principles, considering the technological achievements universally recognised.
- During the design and manufacturing processes, risks were eliminated or reduced as much as possible (implementation of safety in the design and manufacture of the trolley) and the necessary protection measures were adopted against those risks that could not be eliminated.
- **Users are informed on residual risks. For instance, in the case of components and accessories that have to support a load (such as I.V. poles or drawers) the maximum allowable load is indicated both in the corresponding card and on the component itself. If the label is damaged or becomes unreadable, it is necessary to replace it.**
- Materials were chosen on the basis of their reduced toxicity and flammability.
- Considering the intended use of the trolley, attention was paid also to the mutual compatibility between materials and fabrics, biological cells and body fluids.
- The trolley was designed so as to reduce as much as possible all risks due to the accidental leakage of substances in the trolley (considering the trolley itself and the characteristics of the environment it is to be used in)
- The trolley was designed, manufactured and packed in such a way that its features and its performance – considering its intended use – are not subjected to alteration during storage and transportation.
- The normal stress the trolley is subjected to under normal usage conditions does not alter the features and performances described in this document; therefore, the clinical condition of patients, their safety and the safety of third persons cannot be jeopardised (during the device's lifecycle)

- The distinguishing features of the materials used do not change when they come into contact with human body fluids or other fluids (especially as far as flammability is concerned); therefore, safety is guaranteed with all substances and materials that come into contact with the trolley during normal use (or maintenance)
- **It is necessary to report any major accident occurring in relation to the devices to the manufacturer and to the competent authority of the Member State in which it is established.**
- **COMPACT** was designed and manufactured in compliance with the following standards and decrees:
  - the device comply with the general safety and performance requirements of Regulation (EU) 2017/745 (MDR) Annex I,
  - the manufacturing company is certified according to UNI EN ISO 9001 and UNI CEI EN ISO 13485.

## General Prescriptions

This paragraph contains all general prescriptions users must know for a safe and correct use of **COMPACT**. Specific prescriptions are dealt with in the various paragraphs of the present manual.

- **COMPACT** was designed and manufactured with the aim of guaranteeing the utmost personal safety of users, patients and third persons; however an improper use might cause damages to persons and to the trolley itself. The fundamental rules for assembly, usage and maintenance contained in this manual are to be observed in order to avoid altering the intrinsic safety of **COMPACT**.
- **All components and accessories must be housed in the special spaces that are to be found on the trolley (see the corresponding cards and the lay-outs of page CO 1, SU 1, and DE 1) and according to the procedure indicated. If instructions are not followed, the manufacturer declines responsibility for damages to things or persons.**
- **It is forbidden to use accessories that are not either supplied or authorised by GAMMA.**
- **If COMPACT is used under operative or environmental conditions that are different from those indicated in this manual, or if tampering, modifications or substitution of components takes place, the manufacturer declines any responsibility for damages due to defective products and the guarantee is not valid.**
- **Since the trolley is not sterile and, as a consequence, can involve biological risks, all products carried by the trolley must be contained in special packages.**
- **It is forbidden to pour liquids and the like into the containers supplied with the trolley.**
- **Suspend use of COMPACT if any of its parts are damaged. Failure in observing this procedure can cause risks. For assistance ask your supplier.**
- **Do not keep COMPACT near a heat source and do not expose it to direct flame heating elements: these actions might cause damages.**
- **If COMPACT is not going to be used for a long period of time, follow the instructions reported on page. IN 13,**
- **Do not try to disassemble the trolley (unless it needs to be thoroughly cleaned or disposed of) or alter any part of it. Operations of this kind might cause damages. Internal inspections, modifications or fittings must be carried out by technical staff authorised by your supplier.**

- **To clean the trolley use exclusively the products suggested in this document, after disconnecting all electrical appliances.**
- **In case of serious malfunction, extra-ordinary maintenance or any other problem for which no explanation can be found in this manual, we suggest that you ask the manufacturer or your supplier.**

## Residual risk

**COMPACT** was designed and manufactured in such a way that its use cannot jeopardise the safety and the clinical condition of patients, of users or of third persons, provided it is used according to the conditions and for the purposes indicated.

It was not possible to eliminate some risks; however their level is acceptable (considered the advantages it gives to patients) and they are compatible with a high level of health and safety protection.

<b>RESIDUAL RISKS</b> (exposed persons: users, patients and third persons)		
<b>Type of hazard</b>	<b>Risk area</b>	<b>Notes/ Preventive measures</b>
<u>Infection and contamination</u> due to substances or residues of materials that were used or came into contact with the trolley.	Trolley.	The trolley was designed, manufactured and packed so as to minimise risks due to contaminants and residues for the personnel in charge of transportation, storage and use, and for patients (particular attention was paid to exposed tissues and to the time and frequency of exposure).  <b>If the agent is particularly contaminant it is advisable to use appropriate personal protective equipment and to reduce to the minimum frequency and exposure time.</b>
Accidental <u>leakage</u> of substances in the trolley.	Body.	<b>If the trolley is equipped with electrical accessories and there is an accidental leakage of substances into the trolley, disconnect all electrical appliances</b>
<u>Hitting</u> against the trolley.	Trolley.	In order to reduce to the minimum damages caused by hitting against the trolley (and to facilitate cleaning operations), it was designed and manufactured eliminating, as far as possible, sharp surfaces and adding a rubber protection to the inferior part.  <b>During transportation of the trolley, be careful not to hit against things or persons.</b>
<u>Electromagnetic hazard</u> ; interference with other devices.	Electrical accessories (if present).	During design/manufacture the possible influence of magnetic fields and electrical influence were taken into consideration. Risks related to accidental electrical discharge both in normal usage and in first failure conditions were taken into consideration as well (provided that the accessories of the trolley are assembled in the correct way).  <b>Use electrical accessories according to the corresponding instructions.</b>
<u>Fire and overheating.</u>	Trolley.	The trolley was designed and manufactured so as to reduce to the minimum any risks related to the trolley itself.  <b>Use the trolley and its accessories according to the corresponding instructions.</b>
<u>Mechanical and thermal risks</u>	Trolley.	In order to reduce these risks, the trolley underwent stability tests and other tests; The maximum allowable loading weight of each component and accessory is reported on the various cards and on adhesive labels.  <b>Use the trolley and its accessories according to the corresponding instructions.</b>
<u>Biological risk.</u>	All containers.	<b>All products that are used with the trolley must be properly packed, in that the trolley is not sterile and, therefore, can be subjected to biological risks.</b>
<u>Incompatibility with consume products / accessories / other devices.</u>	Trolley.	The trolley was designed and manufactured so as to minimise these risks (by means of compatibility tests). In case of incompatibility, specific notes are to be found in the corresponding instructions.

## Safety labels

Each component or accessory of **COMPACT** containing or sustaining a load (such as a medical devices) is provided with an adhesive label indicating the maximum allowable loading weight.

Each time you use one of these components or accessories, verify that the load you are going to place into or onto it does not exceed the maximum allowable loading weight.

Obviously, in order to check the maximum weight it is necessary to add up all loads that are to be placed on that component/accessory .

If one of these labels is ruined or not readable, it is necessary to replace it.

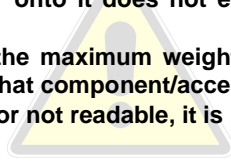

Following is an example:

**DO NOT EXCEED 6 KG LIMIT**

We remind you that 1 kg corresponds to 2.204 lb.

## Environmental conditions

COMPACT must be transported, used and stored in a dry environment and away from heat sources.

## Trasportation and installation

**1** For the transportation of the packed trolley (a) and of its accessories (b) (if there are any) use adequate lifting and transportation means.

During transportation it is possible to stack a maximum of 2 packed trolleys.

The figure on the right shows an example of a correct load configuration).

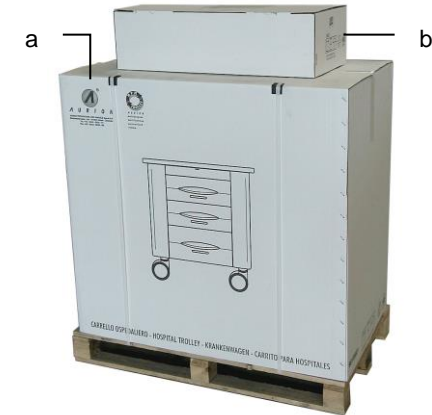

**2** Cut the packing strips (c) and remove the reinforcing corners (d) fixed to the pallet.

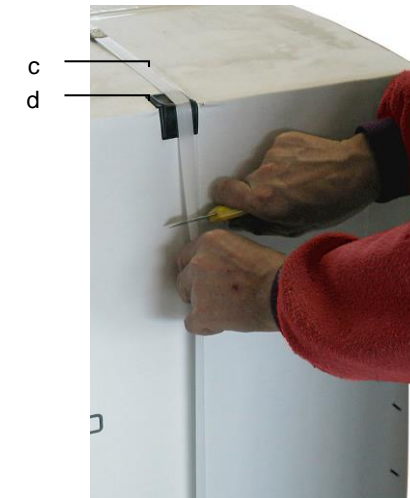

continued

**3** Lift up the box and remove the polystyrene protection at the top (a).



**4** To remove the trolley from the polystyrene base four persons must take hold of the top surface and lift the trolley simultaneously.



**5** Check the content of the package (next paragraph).

Package waste (bag, cardboard box , etc.) must be disposed of in compliance with the local legislation in force. In any case, when it is possible do not get rid of packaging material but keep it: it is the ideal container for "extra-ordinary" transportation".

**6** Open the packages of the various accessories, check their content and assemble them on the trolley (accessories are described starting from pag. CO 1).

## Checking the package content

Before starting to use **COMPACT** it is necessary to check the package content.

Inside the package you will find:

- The components of the standard model;
- The accessories of your model;
- Instructions for use of the trolley (the present document) and instruction for use of the various accessories of third suppliers.

**Check that all these components are in the package and make sure that they are free from any damages due to inadequate transportation. If the content of the package is damaged, contact the retailer you bought the trolley from.**

**In case of return, the trolley is to be given back in the same condition it was in when received (that is in the package used for the consignment).**

## Before use

**Before using the trolley it is necessary to clean it.** See instructions on pag. IN 13.

It is also advisable to carry out some tests before using **COMPACT**, in order to make sure that the trolley and its accessories are free from faults and that they are being used in the correct way.

## Safe usage

**Note:** refer to the cards of the various components and accessories for their specific usage.

**1** To move the trolley, push it by means of the special handles (a) (control their direction by means of the steerable wheel (pag. BO 9).

- Sudden movements of the trolley may cause the material placed on it to fall down
- During normal usage the trolley is stable when its inclination does not exceed 10°.



**2** Once the desired position is reached, wheels can be locked by pushing on brakes (b) (pag. BO 9).

**3** At the end of each working day disconnect the power supply (if it is connected), clean the trolley superficially (pag. IN 13) and place it in a guarded room.

## Maintenance

If **COMPACT** is used according to the instructions given in this manual, it does not require particular maintenance interventions, apart from the ordinary cleaning operations made necessary by usage.

### ATTENTION:

- If some pieces need to be replaced, use exclusively original spare parts.
- The substitution of accessories (for which the procedure corresponds, in most cases, to the assembly sequence in reverse order), is to be carried out while the trolley is disconnected from power supply (if it was connected) and using only compatible products.
- Carry out exclusively operations that are indicated in the present manual.

GAMMA. undertake to supply, on request, wiring diagrams, lists of component parts or other information that might be useful to trained personnel for repairing the parts of the trolley the manufacturer considers repairable.

## Daily cleaning of the trolley

- 1** Unplug the trolley (if it was plugged).
- 2** Remove waste and useless material from containers and supports.
- 3** **The cleaning products which can be used are numerous, be they detergents, degreasing agents or anti-bacterial agents. However their characteristics must be compatible with the materials that are to be cleaned; therefore it is recommended that no type of denatured alcohol or isopropyl is used, especially on swinging pockets.**  
Apply a small quantity of the cleaning product to the surface and run a dry cloth over it.

## Complete cleaning of the trolley

If a complete cleaning of the trolley is necessary, proceed as follows:

- 1** Unplug the trolley (if it was plugged).
- 2** Remove everything that was placed on the trolley.
- 3** Remove all components from the body (described starting from pag. BO 1).
- 4** Remove all components and accessories from the trolley (described starting from pag. BO 1).

- 5** Apply a cleaning product and clean all visible surfaces.

**The cleaning products which can be used are numerous, be they detergents, degreasing agents or anti-bacterial agents. However their characteristics must be compatible with the materials that are to be cleaned; therefore it is recommended that no type of denatured alcohol or isopropyl is used, especially on swinging pockets.**

- 6** For the re-assembly of the trolley, follow the procedure described in steps 1-4 in reverse order.

## Long periods of non-usage

If the trolley is not going to be used for long periods, clean it thoroughly, re-pack it and store it in a dry place.

## “Exceptional” transportation

If the trolley needs to be used in a new site, clean it thoroughly, re-pack it and transport it by means of adequate lifting and transportation equipment.



## De-commissioning and disposal

When the trolley and/or its accessories are to be scrapped, remember that if you get rid of it improperly you might cause environmental pollution, with all consequences deriving from that.

Remember that all trolley components must be disposed of in compliance with the legislation in force.



As far as the disposal of components supplied by third persons is concerned, refer to the instructions supplied with them.

Proceed as follows:

- 1** Clean the trolley thoroughly (pag. IN 13).
- 2** Disassemble all components and accessories.
- 3** Sort the different electrical and recyclable materials (such as the body of the trolley, which is made of Baydur ®) and entrust them to firms that are authorised to recover and dispose of them.
- 4** Scrap the remaining structures and store them in authorised gathering centres.

# BODY

The body of the trolley - i.e. the basic configuration of each **COMPACT** trolley – is supplied with the following components:

- 1) Single piece body (pag. BO 2)
- 2) Top surface (pag. BO 2)
- 3) Needle tub (pag. BO 2)
- 4) Sliding top surface (pag. BO 3)
- 5) Drawer with stainless steel tray (pag. BO 3)
- 6) Transparent swinging pockets (pag. BO 4)
- 7) Pocket catheter holder (pag. BO 4)
- 8) Hooks (pag. BO 4)
- 9) Oxygen bottle holder (pag. BO 5)
- 10) Life-saving medicines drawer (pag. BO 5)
- 11) Waste bin with lid (pag. BO 6)
- 12) Water bottle holder (pag. BO 6)
- 13) Central locking system (pag. BO 6)
- 14) Front opening (pag. BO 8)
- 15) Ampoule opener (pag. BO 8)
- 16) Wheels / braking system (pag. BO 9)



## TECHNICAL DATA

Height	920 mm
Depth	710 mm
Width	775 mm
Weight	42 kg

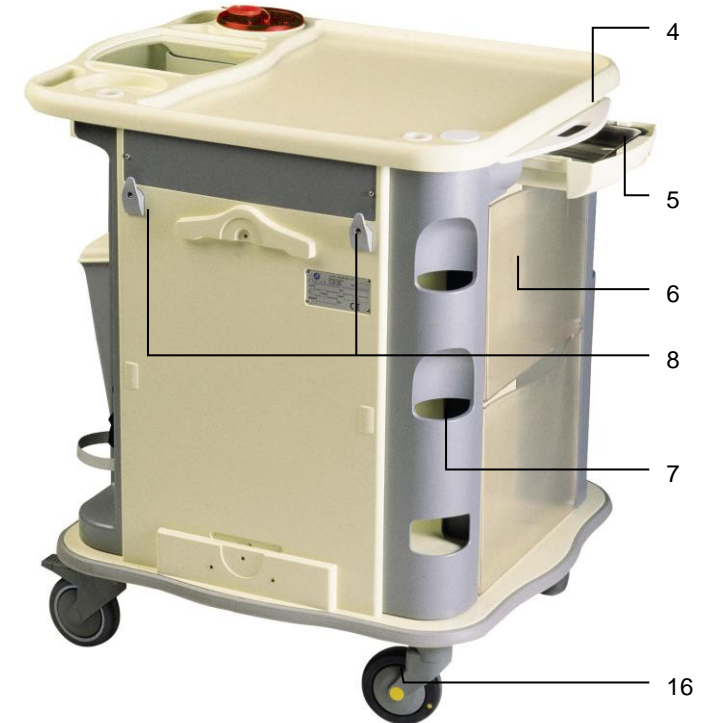

## Single piece body

### Function / Features

The single piece body is made of Baydur® and is the sustaining structure of the trolley. All components and prearrangements for accessories are installed on it.

## Top surface

### Function / Features

On the top surface there are handles (a) to move the trolley, prearrangements to install the various supports and a transparent lid (b) to check the content of the life-saving medicines drawer (pag. CO 5).

### Usage

Place on the top surface only small objects (c)

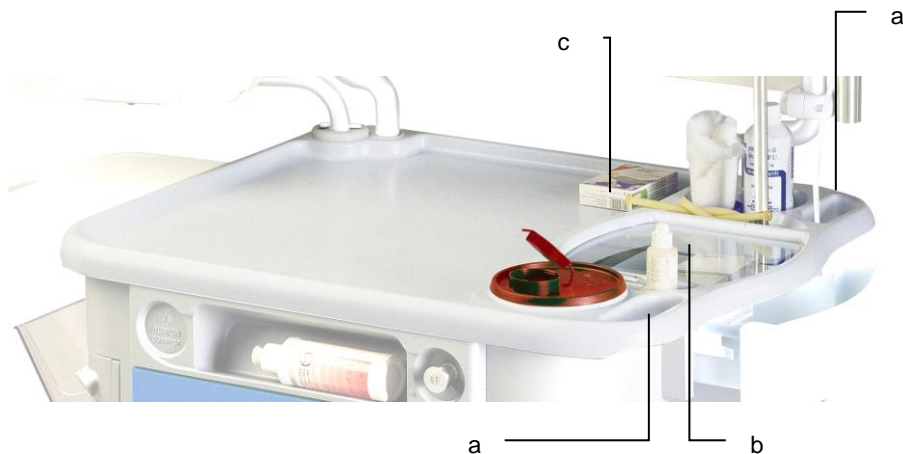

## Needle tub

### Function / Features

The needle tub is fixed into the top surface (pag. CO 1).

### ATTENTION:

**Needle tubs are monouse and therefore they cannot be reused.**

### Usage

**1** Open the lid (a) and insert used needles or cotton into the tub.

**In order to prevent any risks, be extremely careful when inserting waste material into it**

**2** Close the lid.

**3** When the tub is full, close the lid, remove the tub and **dispose of it according to the regulations in force in your hospital.**

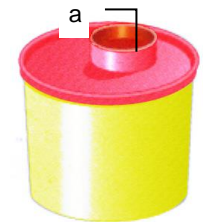
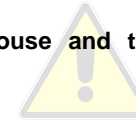

## Sliding top surface

### Function

The sliding top surface shall be used to support small objects and documents.

**DO NOT EXCEED 2 KG LIMIT**

### Usage

**1** When you slide the surface open to its full extension - by means of its special handle (a) -, the drawer underneath opens as well, in order to share in bearing the load.

**Do not exceed the maximum allowable loading weight of 2kg.**

**2** Slide the surface closed by pushing it and help the drawer underneath sliding closed.

### Removal

**1** To remove the sliding top surface it is necessary to remove the drawer with stainless steel tray.

**2** Remove the surface by pulling it out.

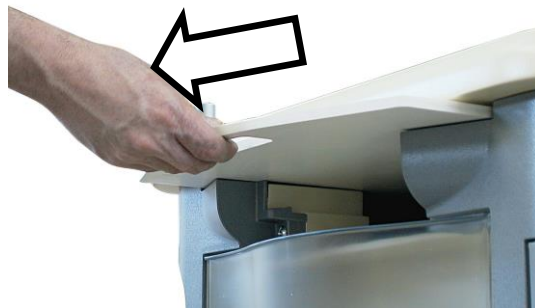
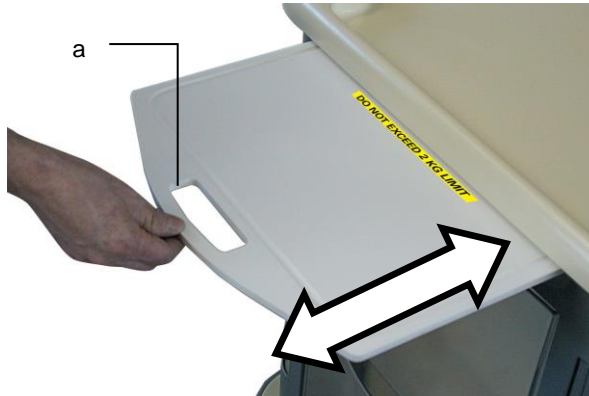

## Drawer with stainless steel tray

### Function / Usage

Open and close the drawer by means of its special handle (a).

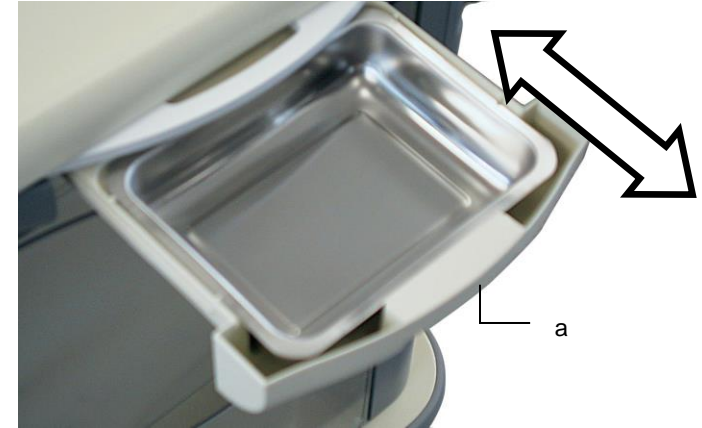

### Removal

**1** Remove the drawer by pulling and lifting it up.

**2** Remove the stainless steel tray (b).

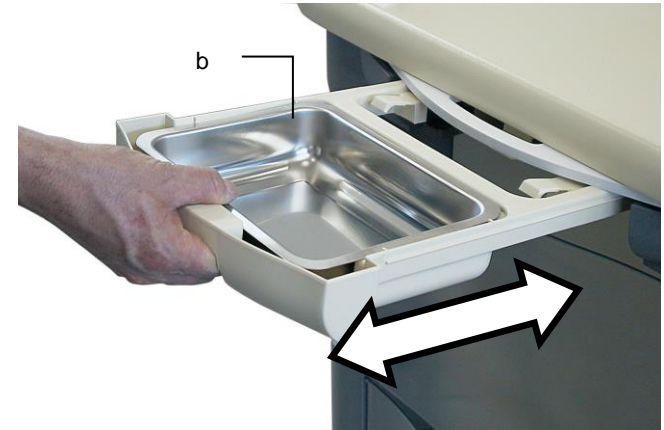

## Transparent swinging pockets

### Function / Usage

Transparent swinging pockets shall be used to contain objects such as solution bottles (a) or clinical records.

Open and close the swinging pockets by rotating them:

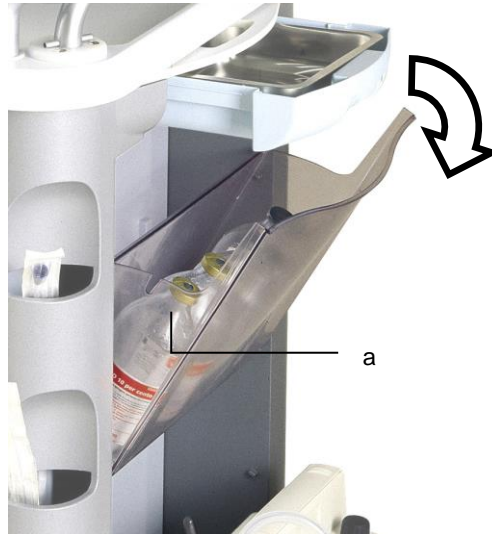

### Removal

Remove the swinging pockets by rotating them and pulling them up.



## Pocket catheter holder

### Function / Features / Usage

Use the pocket catheter holder for catheters or small probes (a).

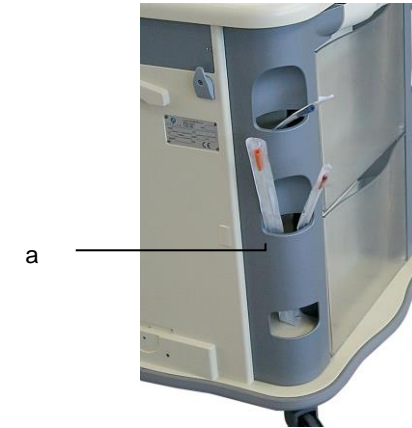

## Hooks

### Function / Usage

Use hooks to hang small accessories such as oxygen masks (a).

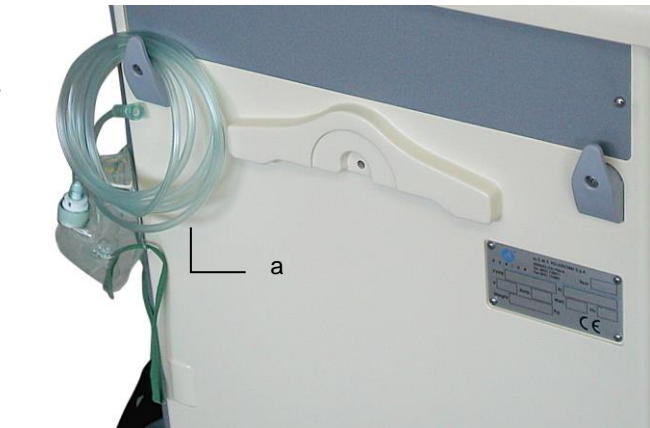

## Oxygen bottle holder

### Function

This space – equipped with a supporting ring (a) and a fixing belt (b) shall be used to hold an oxygen bottle (c).

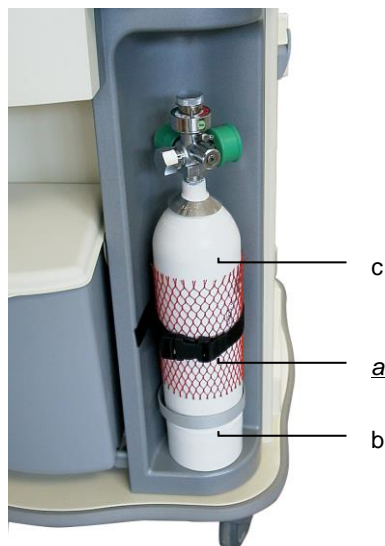

### Usage

- 1** Unfasten the fixing belt.
- 2** Place the oxygen bottle.
- 3** Fasten the belt.

**Note:**  
the belt is to be adapted to the oxygen bottle diameter

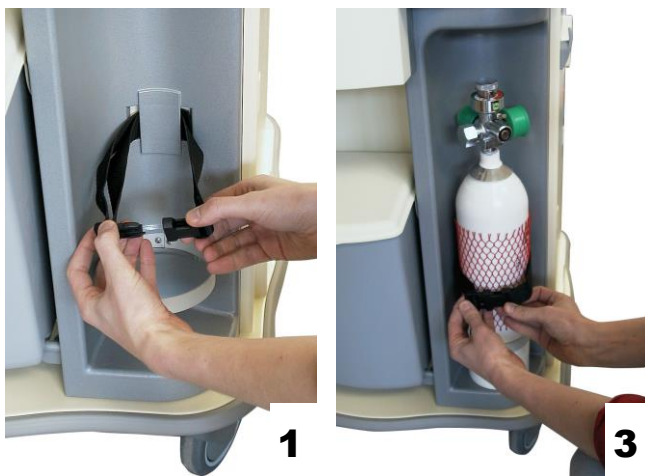

## Life-saving medicines drawer

### Function / Features

This drawer shall be used for all those medicines that must be visible but not within everybody's reach.

### Usage

Open and close the drawer by means of its special handle (b).

**The central locking system of the trolley (if present; pag. BO 6) controls the opening and closing of the drawer.**

**Do not exceed the drawer's maximum allowable loading weight (1kg).**

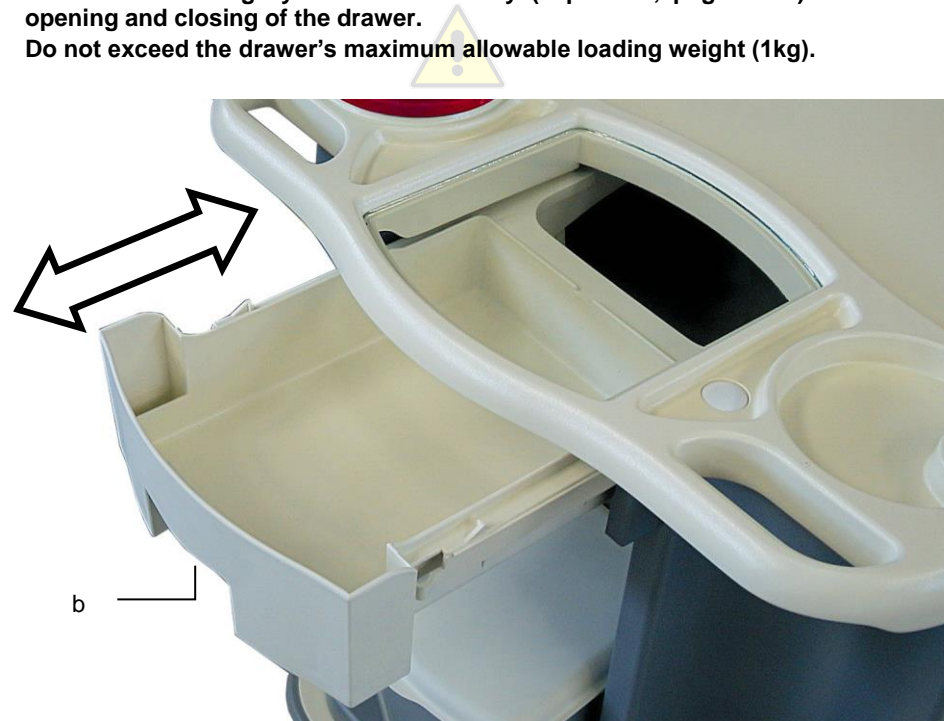

### Removal

Remove the drawer by pulling and lifting it up.

## Waste bin with lid

### Function

Use the waste bin to collect waste.

### Usage

- 1** Before using the waste bin, open its lid (b) and place a plastic bag (c) inside it.
- 2** Lift the lid (b) with your hand and put waste inside.
- 3** Close the lid.

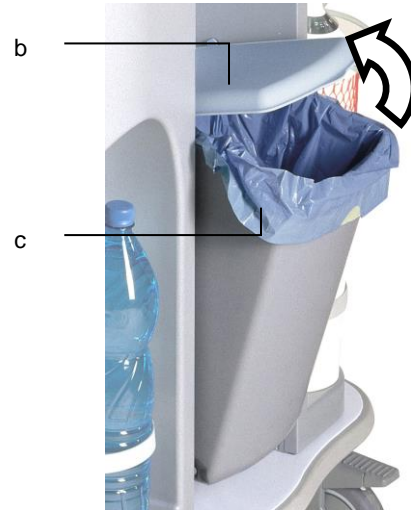

### Removal

- 1** To empty the waste bin or to clean it, lift the lid with one hand and pull the bin out of its runners.
- 2** To unhook the lid you have to push the two tabs where the lid is hinged on the body of the trolley.



**ATTENTION:**  
For the disposal of waste refer to the legislation in force.



## Water bottle holder

### Function / Features

This space – equipped with a supporting (a) ring – can be used to store a bottle.

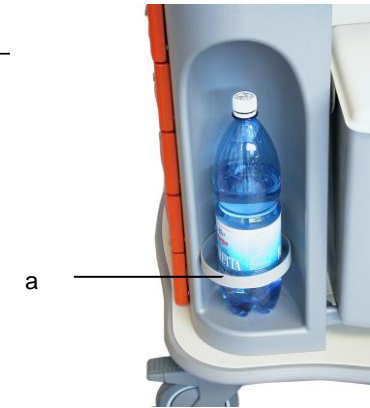

## Central locking system

**COMPACT** can be supplied with a central locking system. Its possible configurations are the following.

### **No lock**

#### Function / Features / Usage

Drawers cannot be locked.



## Key lock

### Function / Features / Usage

This locking system allows to lock drawers by means of its special key.

#### ATTENTION

Remove the second key and keep it in a safe place.

When COMPACT is being moved, drawers must be locked by means of the central locking system (if present: pag. BO 6).

### Usage

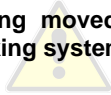

**1** Unlocked drawers position.



**2** Turn the key and remove it to unlock drawers.



## Seal lock with LED

### Function / Features

If you use the seal (not supplied), you must brake it in order to open the drawers. In this way it is possible to check that the drawers and their contents have not been tampered.

#### ATTENTION:

You can use seals supplied either by GAMMA or by any other supplier, provided their breaking load does not exceed 10k. Failing this, GAMMA decline any responsibility.



### Usage

**1** To lock drawers you have to push the knob (a) and insert the seal (b), if present. The red (c) LED will automatically turn on.

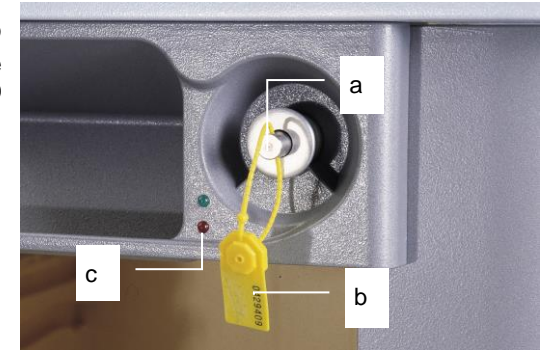

**2** To unlock drawers you have to break the seal (if present) and pull the knob. The green LED will automatically turn on.

#### NOTE:

If no LED is on, replace the battery.

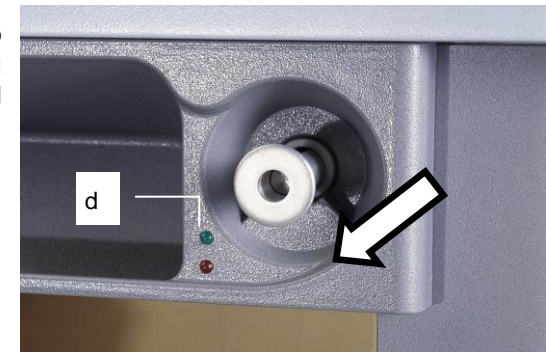



## Seal lock

It has the same function and usage as the seal lock with LED but has no LED.



## Front opening space

### Function / Usage

Use this space for small objects, such as the defibrillator gel.



## Ampoule opener

### Function

This container – equipped with two holes (a, with two different diameters) – allows to break ampoules (b) and gather the broken part.

### Usage

- 1** Insert the ampoule in one of the two holes, depending on its diameter.
- 2** Push the ampoule down until it breaks.

### Emptying out

When the ampoule opener is full and it needs to be emptied – or in case of complete cleaning of the trolley – proceed as follows:

- 1** Remove the ampoule opener by pulling the special hole on the bottom of it.
- 2** Empty the container.
- 3** Place the ampoule opener back, following the same procedure in reverse order.

### ATTENTION:

For the waste disposal refer to the regulations in force in your hospital.

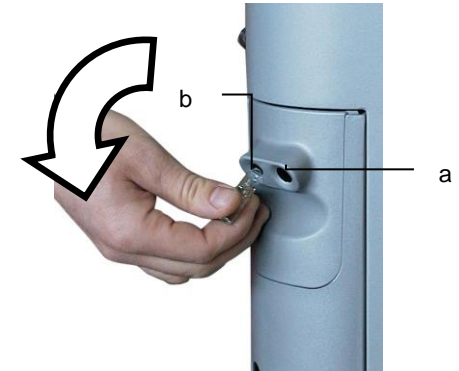

## Wheels / braking system

### Function / Features

In order to avoid unexpected movements of the trolley, **COMPACT** is equipped with two wheels with brakes.

Wheels diameter 125 mm.

### Usage / Removal

Operate the brakes by pushing with your foot on the special lever (c).

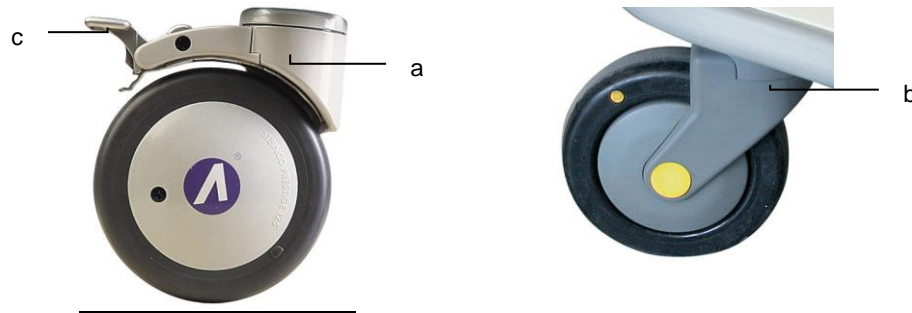

## Wheel with brakes

**1** Brake off



**2** Brake on



## Steerable wheel (If present)

**1** Brake off



**2** Steering lock



**3** Brake on



# CONTAINERS (ACCESSORIES)

This section describes all accessories devoted to contain medicines, used disposable devices, etc. that can be assembled on **COMPACT**.

In this page there is an usage example for these accessories.

- 1) Front drawers (pag. CO 3)
- 2) Wirebaskets (pag. CO 4)
- 3) Trays (pag. CO 5)
- 4) Dispenser (pag. CO 6)
- 5) Stainless steel shelves (pag. CO 7)
- 6) Basins (pag. CO 8)
- 7) Doors with seal lock (pag. CO 9)

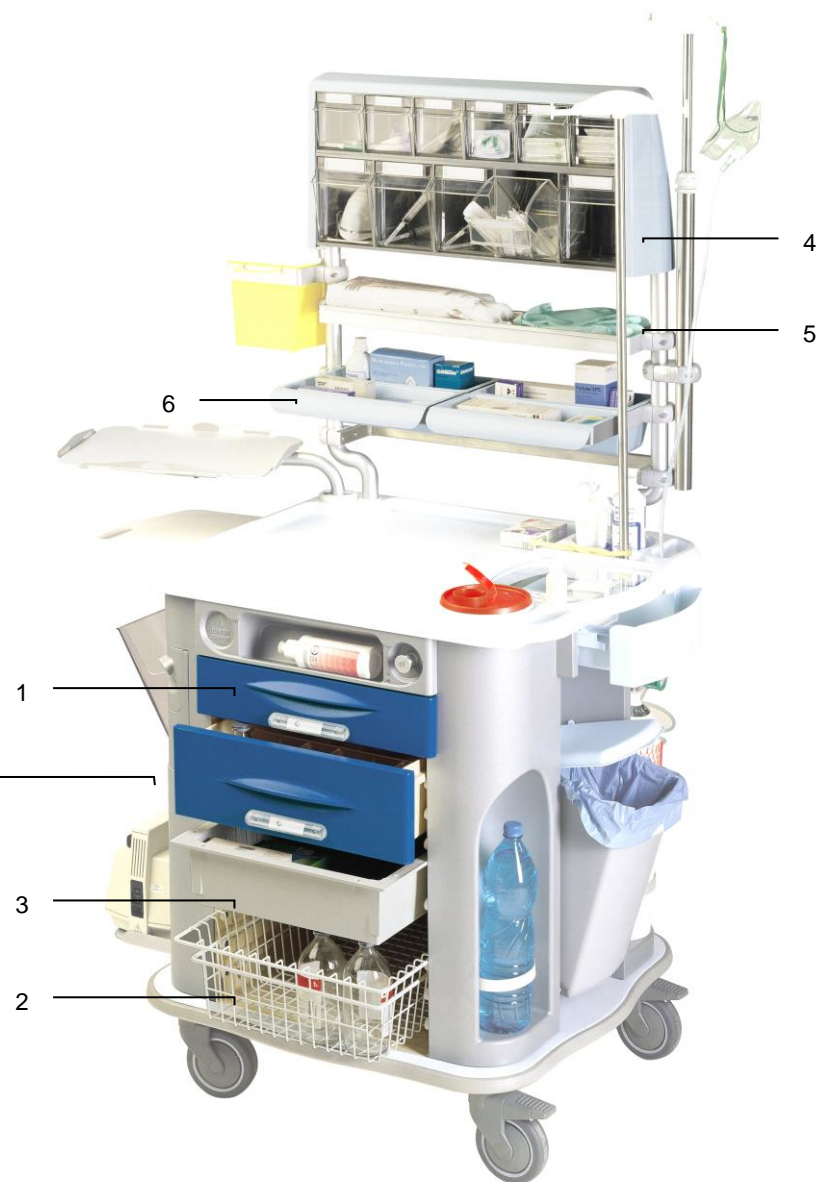

## Front drawers

### **ATTENTION:**

For a correct and safe use of the front drawers with COMPACT it is necessary to read carefully the text contained in sections "INFORMATION" (from pag. IN 1) and "BODY" (from pag. BO 1) of the usage manual.

The drawers must be put in the special openings which can be found on the body of the trolley (see lay-out on page CO 1).

It is forbidden to use drawers that are different from those supplied by GAMMA.

### Function

The front drawer shall be used to contain disposable medicines and medical devices.

### Features

The front drawer is made of BAYDUR® polyurethane

### Assembly

**1** Before starting the assembly of drawers, make sure that the central locking system (if present) is in the "unlocked" position.

**2** Insert the drawer (or drawers) into the special runners.

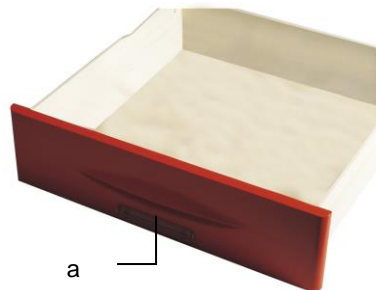
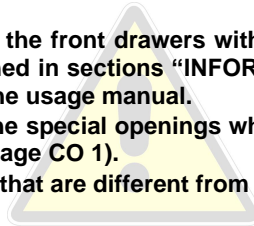

### Usage

Open the drawer and put medicines or devices into it.

### **ATTENTION:**

The opening and closing of front drawers is conditioned by the central locking system (if present pag. BO 6) It is forbidden to pour liquids and the like into drawers.

The maximum allowable loading weight appearing on the bottom of each drawer corresponds to the maximum safety load that guarantees the stability of the trolley if all drawers are opened simultaneously.

Note:

Drawer are equipped with a label holder (a). Use it to write on it the contents of the drawers.

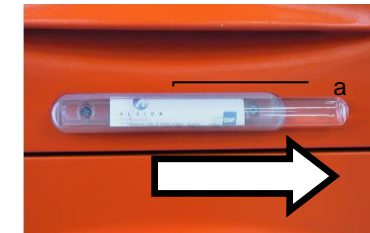

### Removal

Pull out the drawer by opening it completely and lifting it up.

### Maintenance

Refer to what is reported on pag. IN 12

### Decommissioning and disposal

Refer to what is reported on pag. IN 14.

## Dividers

### **ATTENTION:**

For a correct and safe usage of dividers with COMPACT it is necessary to read carefully the text contained in sections "INFORMATION" (from pag. IN 1) and "BODY" (from pag. BO 1) of the usage instructions.

Dividers must be put inside drawers (pag. CO 2) (see the lay-out on page CO 1).

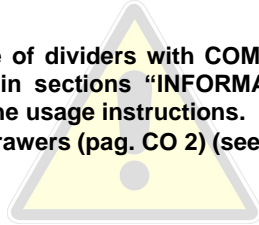

### **Function**

Dividers shall be used to create separate compartments inside the drawers of COMPACT.



### **Features**

Dividers supplied by GAMMA are available in different materials and sizes.

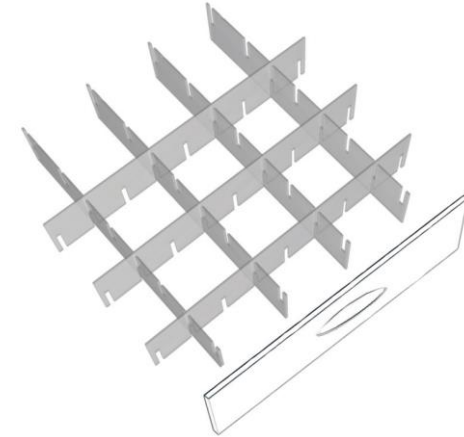

### **Assembly**

Put the divider inside the drawer (pag. CO 2)

### **Usage**

Put the various products inside the compartments created by dividers.

### **Removal**

Remove dividers by lifting them up.

### **Maintenance**

Refer to what is reported on pag. IN 12.

### **Decommissioning and disposal**

Refer to what is reported on pag. IN 14.

## Wirebaskets

### **ATTENTION:**

For a correct and safe usage of wirebaskets with COMPACT it is necessary to read carefully the text contained in sections "INFORMATION" (da pag. IN 1) and "BODY" (from pag. BO 1) of the usage instructions.

Wirebaskets must be put in the special openings that are to be found on the body of the trolley (see lay-out on pag. CO 1).

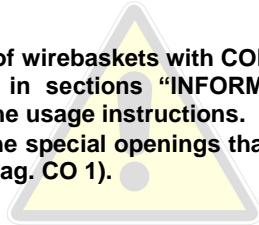

### Function

Wirebaskets shall be used to store disposable medicines or medical devices

### Features

Wirebaskets are available in different heights.



### Assembly

Insert the wirebasket into the special runners, after making sure the central locking system (if present: pag. IN 6) is unlocked.



### **ATTENTION:**

do not insert wirebaskets into runners which are supplied with drawer wheels (a).

### Usage

**1** Put the various disposable medicines and/or medical devices into them.

**2** Pull out the wirebasket by keeping the removed part of its rim up with your hand.

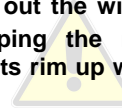

### Maintenance

Refer to what is reported on pag. IN 12.

### Decommissioning and disposal

Refer to what is reported on pag. IN 14.

## Trays

### **ATTENTION:**

For a correct and safe usage of trays with COMPACT it is necessary to read carefully the text contained in sections "INFORMATION" (from pag. IN 1) and "BODY" (from pag. BO 1) of the usage instructions.

Trays must be put in the special openings that are to be found on the body of the trolley (see lay-out on pag. CO 1).

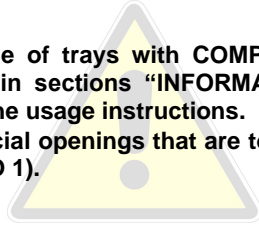

### Function

Trays shall be used to store disposable medicines or medical devices.

### Features

Trays are available in different heights and can be made of ABS or light acrylic.



### Assembly

Insert the tray into the special runners after checking that the locking system (if present: pag. IN 6) is unlocked.

### **ATTENTION:**

do not insert the tray into runners which are supplied with drawer wheels (a).



### Usage

**1** Put the various disposable medicines and medical devices into it.

It is forbidden to pour liquids and the like into trays.

**2** Pull out the tray by keeping the removed part of its rim up with your hand.

### Maintenance

Refer to what is reported on pag. IN 12.

### Decommissioning and disposal

Refer to what is reported on pag. IN 14.



## Dispenser

### **ATTENTION:**

For a correct and safe use of the dispenser with COMPACT it is necessary to read carefully the text contained in sections "INFORMATION" (from pag. IN 1) and "BODY" (from pag. BO 1) of the usage instructions.

The dispenser must be placed in the special spaces that can be found on the trolley top (see lay-out on pag. CO 1).

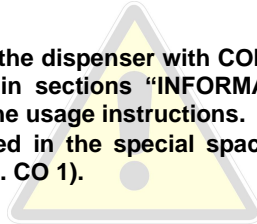

### **Function / Usage**

The dispenser shall be used to store disposable medicines or medical devices.

**It is forbidden to pour liquids and the like into the dispenser.**

### **Features**

The dispenser is equipped with 11 swinging (a) containers.

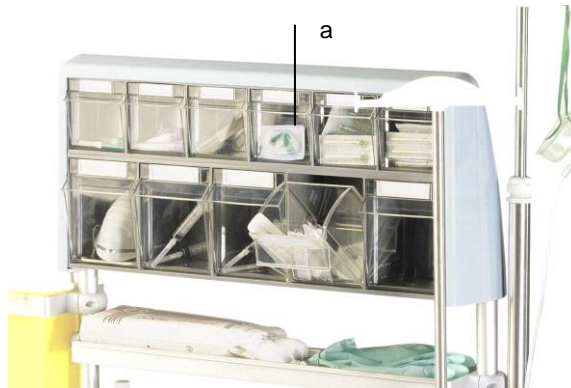

### **Assembly**

**1** Insert the supporting poles into the special dispenser holes.

**2** Insert the whole block into the special holes in the body of the trolley, as shown in the figure on the right.



### **Removal**

Pull out the dispenser by lifting it up.

### **Maintenance**

Refer to what is reported on pag. IN 12.

### **Decommissioning and disposal**

Refer to what is reported on pag. IN 14.



## Stainless steel shelves

### **ATTENTION:**

For a correct and safe use of stainless steel shelves with COMPACT it is necessary to read carefully the text contained in sections "INFORMATION" (from pag. IN 1) and "BODY" (from pag. BO 1) of the usage instructions.

Stainless steel shelves must be placed on the special holding frames, which are fixed on supporting poles (see lay-out on pag. CO 1).

It is forbidden to use accessories that are different from those supplied by GAMMA.

### Function / features

Stainless steel shelves shall be used to contain small objects, such as cotton or gloves.

They are supplied together with their holding frame.



### Assembly

**1** Assemble the shelf holding frame (pag. SU 7).

**2** Place the shelf onto its holding frame.

### Usage

Lay the various objects onto shelves.

It is forbidden to pour liquids and the like into shelves.



### Removal

Follow the procedure described for assembly in reverse order.

### Maintenance

Refer to what is reported on pag. IN 12.

### Decommissioning and disposal

Refer to what is reported on pag. IN 14.

## Basins

### **ATTENTION:**

For a correct and safe use of basins with COMPACT it is necessary to read carefully the text contained in sections "INFORMATION" (from pag. IN 1) and "BODY" (from pag. BO 1) of the usage instructions.

Basins must be placed onto their special holding frames (pag. SU 7); (see lay-out on pag. CO 1).

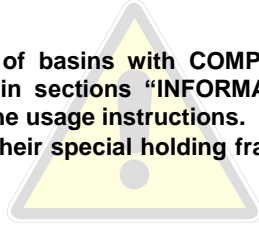

### Function

Basins shall be used to store disposable medicines or medical devices.

### Features

Basins are available in the following heights: 90 mm and 45mm.

They are supplied together with their holding frame.



### Assembly

**1** Assemble the basin holding frame (pag. SU 7).

**2** Place the basin onto its frame.

### Usage

Lay the various objects inside basins.



It is forbidden to pour liquids and the like into basins.



### Removal

Follow the procedure described for assembly in reverse order.

### Maintenance

Refer to what is reported on pag. IN 12.

### Decommissioning and disposal

Refer to what is reported on pag. IN 14.

## Doors with seal lock

### **ATTENTION:**

For a correct and safe usage of the doors with seal-lock with COMPACT, it is necessary to read carefully the text contained in sections "INFORMATION" (from pag. IN 1) and "BODY" (from pag. BO 1) of the usage instructions.

It is forbidden to use doors that are different from those supplied by GAMMA.

It is possible to use seals supplied either by GAMMA or by any other supplier, provided their breaking load does not exceed 10 kg; failing this GAMMA decline any responsibility.

Failure to observe the prescriptions and the procedures described in this document absolves the manufacturer of any responsibility for damages to things or people.

### Function

Doors allow to close the various wirebaskets, trays and other objects that are stored in the body or in the trolley

### Features

They are made of a transparent opaque material

They are equipped with magnets so as to prevent accidental opening while the trolley is moved.

Locking system with safety seal

180° rotation of doors to provide easier access

They are available in two dimensions:

- H 490 in combination with a drawer H100
- H 590 to close the body of the trolley completely



### Usage

**1** Open and close the doors by using their knobs

**2** Insert the seal into the hole in the hinge

**3** To unlock the doors you have to break the seal (if present) and open the doors by using their knobs

### Maintenance

Refer to what is reported on pag. IN 12.

### Decommissioning and disposal

Refer to what is reported on pag. IN 14.

# SUPPORTS (ACCESSORIES)

This section describes accessories devoted to supporting medicines and medical devices that can be carried by **COMPACT**.

- 1) I.V. pole (pag. SU 2)
- 2) Telescopic I.V. pole (pag. SU 3)
- 3) Holding frame (pag. SU 4)
- 4) Holding bar (pag. SU 6)
- 5) Basin holding (pag. SU 7)
- 6) Tub holder (pag. SU 9)
- 7) Shelf for suction pump (pag. SU 10)
- 8) Oxygen bottle holder (SMALL or LARGE) (pag. SU 11)
- 9) Rotating instrument carrying tray (pag. SU 13)
- 10) Lockable rotating instrument carrying tray (pag. SU 15)
- 11) Cardiac massage board (pag. SU 17)
- 12) Perimetral protection (pag. SU 19)
- 13) Paediatric mattress (pag. SU 20)

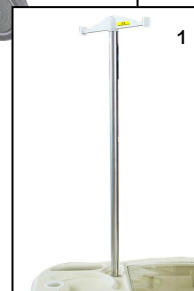
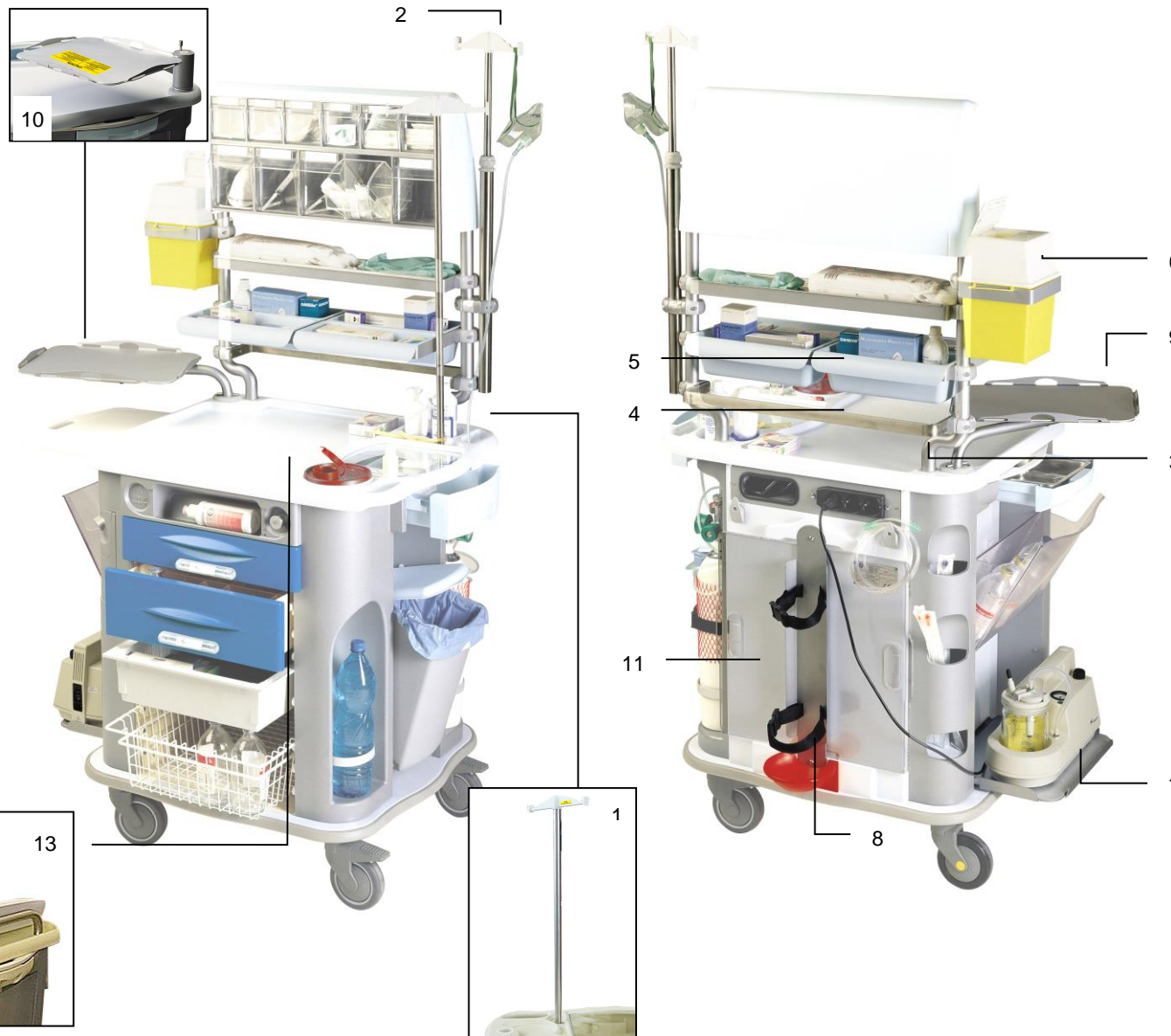

## I.V. pole

### **ATTENTION:**

For a correct and safe use of the I.V. pole with COMPACT it is necessary to read carefully the text contained in sections "INFORMATION" (from pag. IN 1) and "BODY" (from pag. BO 1) of the usage instructions.

The I.V. pole must be placed into the special holes that are to be found on the top surface of the trolley (see lay-out on pag. SU 1).

### Function

This accessory shall be used to carry a maximum of two bottles or small accessories such as hospital masks.

### Features

Height: 850 mm.

Maximum allowable loading weight: 2kg.

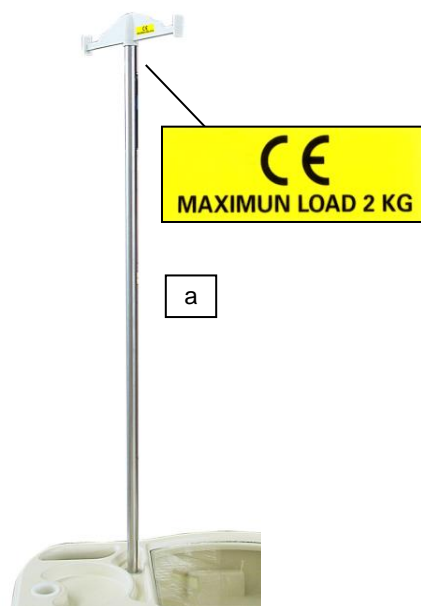
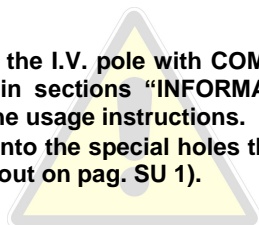

### Assembly

- 1** Either remove the special lid from the top surface or use the hole for the rotating bushing.
- 2** Insert the I.V. pole into the special tray (pag. SU 13).



Note: the I.V. pole can be either inserted in the hole devoted to the Lockable rotating instrument carrying tray (pag. SU 15), or fixed directly onto the pole of the holding frame (pag. SU 4).

### Usage

Hang the various disposable medicines and/or medical devices on it.

**Make sure not to exceed the maximum allowable loading weight indicated on the adesive label (a) stuck on the upper part of the pole.**

### Removal

Remove the I.V. pole by pulling it up.

### Maintenance

Refer to what is reported on pag. IN 12.

### Decommissioning and disposal

Refer to what is reported on pag. IN 14.

## Telescopic I.V. pole

### **ATTENTION:**

For a correct and safe use of the telescopic I.V. pole with COMPACT it is necessary to read carefully the text contained in sections “INFORMATION” (from pag. IN 1) and “BODY” (from pag. BO 1) of the usage instructions.

The telescopic I.V. pole must be placed into the special holes that are to be found on the top surface of the trolley (see lay-out on page SU 1).

Failure to observe the prescriptions and the procedures described in this document absolves the manufacturer of any responsibility for damages to things or people.

### Function

This accessory shall be used to carry a maximum of two I.V. bags or small accessories such as hospital masks.

### Features

Height: 600-1000 mm

Maximum allowable loading weight: 2kg.

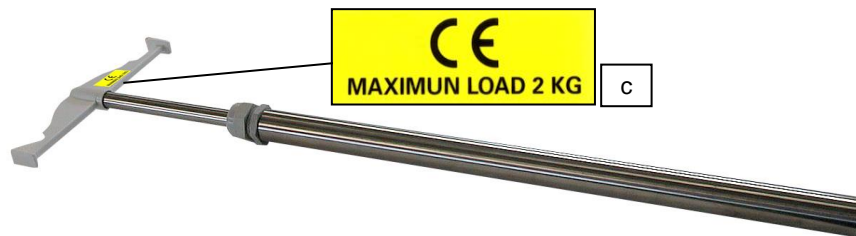

### Assembly

**1** Remove the special lid from the top surface.

**2** Insert the pole into its bushing (a).

### Usage

**1** Unscrew the clamp (b) to adjust the pole height and tighten.

**2** Hang the various disposable medicines and/or medical devices on it.

**Make sure not to exceed the maximum allowable loading weight indicated on the adhesive label (c) stuck on the upper part of the pole.**

### Removal

Remove the I.V. pole by pulling it up.

### Maintenance

Refer to what is reported on pag. IN 12.

### Decommissioning and disposal

Refer to what is reported on pag. IN 14.

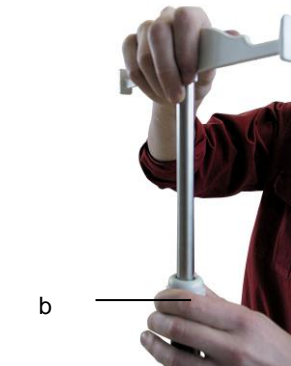

**Holding frame**

**ATTENTION:**

For a correct and safe usage of the holding frame with COMPACT it is necessary to read carefully the text contained in sections "INFORMATION" (from pag. IN 1) and "BODY" (from pag. BO 1) of the usage manual.

The holding frame must be placed in the special holes that are to be found on the top surface of the trolley (see lay-out on pag. SU 1).

It is forbidden to use accessories that are different from those supplied by GAMMA.

Failure to observe the prescriptions and the procedures described in this document absolves the manufacturer of any responsibility for damages to things or people.

**Function / Features**

The holding frame shall be used to sustain various accessories (as shown in the pictures on this page)

**SMALL** (containing 2 90mm basins).

**LARGE** (containing 2 45mm and 2 90 mm basins).

**DOUBLE** (containing 2 90mm and 4 45mm basins)

**DISPENSER**



These configurations are available in either blue or beige.



## Assembly

- 1** Remove the two bushings from the top surface of the trolley. **2** Insert the poles of the holding frame into it.



- 3** The final position of poles shall be the following:



- 5** Follow the assembly procedure of the basins (pag. CO 7).

## Removal

Follow the procedure described for assembly in reverse order.

## Maintenance

Refer to what is reported on pag. IN 12.

## Decommissioning and disposal

Refer to what is reported on pag. IN 14.



## Holding bar

### **ATTENTION:**

For a correct and safe usage of the holding bar with COMPACT it is necessary to read carefully the text contained in sections "INFORMATION" (from pag. IN 1) and "BODY" (from pag. BO 1) of the usage instructions.

The holding bar must be placed onto the holding frame (see lay-out on pag. SU 1). It is forbidden to use accessories that are different from those supplied by GAMMA.

Failure to observe the prescriptions and the procedures described in this document absolves the manufacturer of any responsibility for damages to things or people.

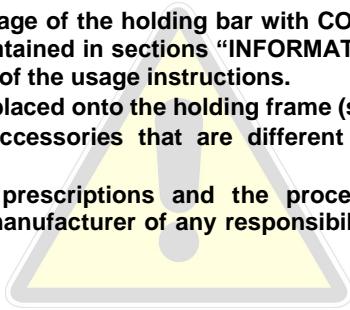

### Function

The holding bar can support 25mm or 30mm standard clamps.

### Features

The bar is made of stainless steel and is available in the following dimensions: 25 x 10 mm (cod. .0690); 30 x 10 mm (cod. .0691).



b

**DO NOT EXCEED 6 KG LIMIT**

### Assembly

**1** Insert the holding bar between the two bars of the holding frame.



**2** Insert the clamp (a) and fix it with a cross screwdriver.



**3** Carry out the same operation on the other end of the bar.

### Usage

Hang accessories onto it.

**Make sure not to exceed the maximum allowable loading weight indicated on the adhesive label (b) ) stuck on the upper part of the pole.**

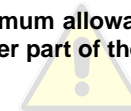

### Removal

Follow the procedure described for assembly in reverse order.

### Maintenance

Refer to what is reported on pag. IN 12.

### Decommissioning and disposal

Refer to what is reported on pag. IN 14.

## Basin holding frame

### ATTENTION:

For a correct and safe use of the basin holding frame with COMPACT it is necessary to read carefully the text contained in sections "INFORMATION" (from pag. IN 1) and "BODY" (from pag. BO 1) of the usage instructions.

The basin holding frame must be placed on the poles of the holding frame (pag. SU 4) (see lay-out on pag. SU 1).

It is forbidden to use accessories that are different from those supplied by GAMMA.

Failure to observe the prescriptions and the procedures described in this document absolves the manufacturer of any responsibility for damages to things or people.

### Function/Features

This holding frame has the function of supporting basins (pag. CO 7).



### Assembly

**1** Insert the frame between the two poles of the holding frame.



**2** Insert the clamp (a) and fix it with a cross screwdriver.



**3** Repeat steps 1 and 2 for all basin holding frames.

## **Usage**

Place the basin onto the frame.

## **Removal**

Follow the procedure described for assembly in reverse order.

## **Maintenance**

Refer to what is reported on pag. IN 12.

## **Decommissioning and disposal**

Refer to what is reported on pag. IN 14.

## Tub holder

### ATTENTION:

For a correct and safe usage of the tub holder with COMPACT it is necessary to read carefully the text contained in sections “INFORMATION” (from pag. IN 1) and “BODY” (from pag. BO 1) of the usage instructions.

The tub holder must be placed on the poles of the holding frame (pag. SU 4; see lay-out on pag. SU 1).

Failure to observe the prescriptions and the procedures described in this document absolves the manufacturer of any responsibility for damages to things or people.

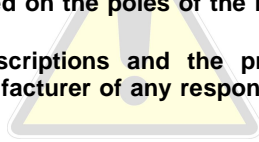

### Function / Features

This support has the function of sustaining needle tubs (either rectangular, as shown in this picture, or circular tubs).

The tub holder can be easily placed everywhere on the poles of the supporting frame (pag. SU 4).



### Assembly

- 1** Assemble the support on one of the two poles of the holding frame
- 2** Insert the clamp (a) and fix it with a cross screwdriver.

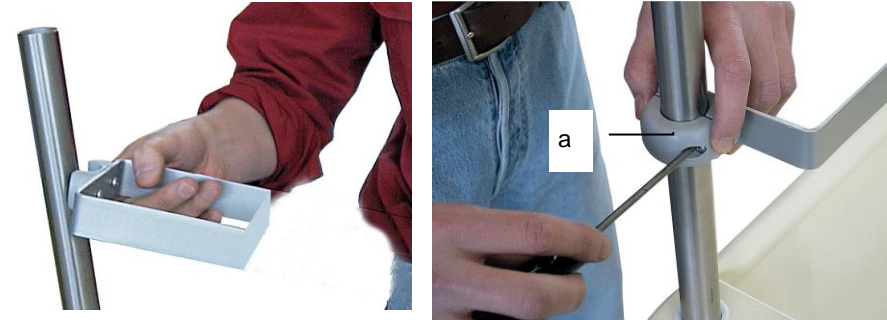

### Usage

Insert the tub.

### Removal

Follow the procedure described for assembly in reverse order.

### Maintenance

Refer to what is reported on pag. IN 12.

### Decommissioning and disposal

Refer to what is reported on pag. IN 14.

## Shelf for suction pump

**ATTENTION:**

For a correct and safe use of the shelf with COMPACT it is necessary to read carefully the text contained in sections "INFORMATION" (from pag. IN 1) and "BODY" (from pag. BO 1) of the usage instructions.

The shelf for the suction pump must be placed in the special space on the body of the trolley (see lay-out on page SU 1).

Failure to observe the prescriptions and the procedures described in this document absolves the manufacturer of any responsibility for damages to things or people.

**Function**

This shelf has the function of supporting the suction pump.

**Features**

Dimensions: 385 x 285 mm



example

**Assembly**

- 1** Remove the lower swinging pocket (pag. BO 4).
- 2** Insert the shelf, taking care that the pivot (a) on the body of the trolley is inside the slot (b).



**Usage**

Place the suction pump on it.

**Make sure not to exceed the maximum allowable loading weight of 6kg (reported in the label that is stuck on the shelf base).**

**Removal**

Follow the procedure described for assembly in reverse order.

**Maintenance**

Refer to what is reported on pag. IN 12.

**Decommissioning and disposal**

Refer to what is reported on pag. IN 14.

## Oxygen bottle holder (SMALL or LARGE)

**ATTENTION:**

For a correct and safe usage of the oxygen bottle holder with COMPACT it is necessary to read carefully the text contained in sections "INFORMATION" (from pag. IN 1) and "BODY" (from pag. BO 1) of the usage instructions.

The oxygen bottle holder must be placed in the special space on the body of the trolley (see lay-out on pag. SU 1).

**IT IS STRICTLY FORBIDDEN TO ASSEMBLE THIS ACCESSORY IN PRESENCE OF THE POWER PACK.**

Failure to observe the prescriptions and the procedures described in this document absolves the manufacturer of any responsibility for damages to things or people.

**Function** This accessory shall be used to store an additional oxygen bottle.

**Features**

Each of the two types of bottle holders can bear oxygen bottles with a specific diameter and capacity:

SMALL: 2-5 l of capacity; 100mm of diameter;  
LARGE: 3-10l of capacity; 150mm of diameter.



**Assembly**

**1** Make the upper hole



**2** Drill the lower part of the body in correspondence with the three pre-set points



**3** Lay the plate on the body of the trolley and screw up the upper fixing screw



**4** From the inside of the body, insert the stop nut of the screw.



continued

- 5** Tighten up the screw by means of the special wrench (the nut must be fixed from the inside). **6** Repeat steps 3-5 for the fixing screws on the lower part of the plate.



- 7** Fix the oxygen bottle holder with 2 cross screws.



## Usage

### **ATTENTION**

Use exclusively **SMALL** or **LARGE** oxygen bottles.  
The oxygen bottles shall be equipped with all necessary declarations (that guarantee a reduced risk of fire or explosion).  
Do not exceed the maximum loading weight of 15 kg.

- 1** Unfasten the fixing belt.  
**2** Place the oxygen bottle.



- 3** Adjust the fixing belt according to the oxygen bottle diameter for higher safety.  
**4** Fasten the belt.  
**5** Remove the oxygen bottle after unfastening the belt.



Note:

Use the double belt if the oxygen bottle is taller.

## Removal

Follow the procedure described for assembly in reverse order.

## Maintenance

Refer to what is reported on pag. IN 12.

## Decommissioning and disposal

Refer to what is reported on pag. IN 14.

## Rotating instrument carrying tray

### ATTENTION:

For a correct and safe use of the rotating tray with COMPACT it is necessary to read carefully the text container in sections "INFORMATION" (from pag. IN 1) and "BODY" (from pag. BO 1) of the usage instructions.

The rotating instrument carrying tray must be placed in the special space on the body of the trolley (see lay-out on page SU1).

Failure to observe the prescriptions and the procedures described in this document absolves the manufacturer of any responsibility for damages to things or people.

### Function

This accessory shall be used as a support for defibrillators or monitors.

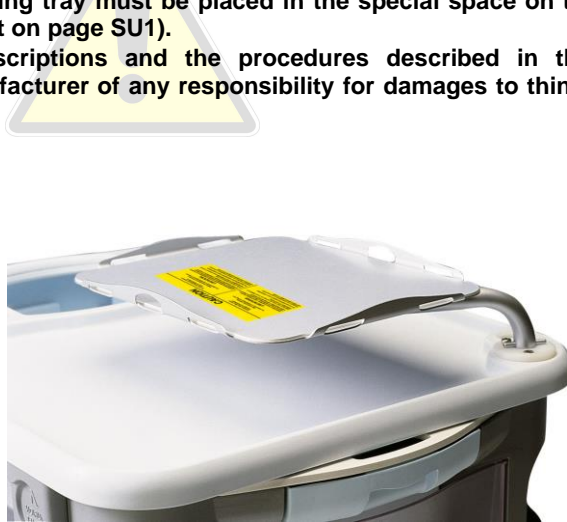

### Features

The surface of the tray is equipped with an anti-sliding pad.

Dimensions: 38x31 cm

### Assembly

- 1 Remove the lid from the left part of the surface.
- 2 Insert the flanged pivot into the hole.



- 3 Rotate the support base until holes coincide.
- 4 Fix the frame with socket head screws, by means of an Allen wrench.



continued

## CAUTION

Improper Use May cause  
Damage To Defibrillator

See instruction manual  
for operation of defibrillator swing arm

### LIMITATIONS:

Defibrillator must fit platform: raised flanges must be external to base of defibrillator. (See Instruction Manual to match defibrillator with appropriate platform)

Maximum load 12 kg. Do not lean on or pull Platform or Defibrillator to move trolley

Do not put additional weight to top of defibrillator

Transport only with platform in secure position and within external edges of trolley

Un Uso Improprio può Causare  
Danni al Defibrillatore

Vedere manuale per le istruzioni  
per applicazione del defibrillatore al vassoio:

### LIMITAZIONI:

Il defibrillatore deve essere di misura compatibile con il vassoio  
Posizionare il defibrillatore all'interno dei bordi del vassoio  
(Si veda manuale per combinare il defibrillatore al vassoio)

Carico massimo ammesso di 12 KG  
Non appoggiarsi o tirare il defibrillatore per muovere il carrello

Non aggiungere pesi supplementari sopra il defibrillatore

Spostare il carrello con il vassoio in posizione di sicurezza  
posizionato internamente alla sagoma del carrello



- 5** Insert the monitor holder into the special guide



### Removal

Follow the procedure described for assembly in reverse order.

### Maintenance

Refer to what is reported on pag. IN 12.

### Decommissioning and disposal

Refer to what is reported on pag. IN 14.

### Usage

#### **ATTENTION**

Improper use of the rotating tray may cause damages to the defibrillator.

Make sure you do not exceed the maximum allowable loading weight of 12 kg (reported in the label that is stuck to the base of the tray surface).

The dimensions of the defibrillator must be compatible with the tray.

Do not lean on or pull the defibrillator to move the trolley.

Do not lay additional weights onto the defibrillator.

When you move the trolley, the tray shall be moved back to the safety position – within the trolley profile

- 1** Rotate the surface into the desired position.

- 2** Lay the defibrillator within tray borders.

## Lockable rotating instrument carrying tray

### ATTENTION:

For a correct and safe usage of the rotating tray with COMPACT it is necessary to read carefully the text contained in sections "INFORMATION" (from pag. IN 1) and "BODY" (from pag. BO 1) of the usage instructions.

The rotating instrument carrying tray must be placed in the special space on the body of the trolley (see lay-out on page SU 1).

This accessory cannot be installed if the holding frame is assembled on the trolley (pag. SU 4)

Failure to observe the prescriptions and the procedures described in this document absolves the manufacturer of any responsibility for damages to things or people.

### Function

This accessory shall be used as a support for defibrillators or monitors.

### Features

This accessory is equipped with an anti-sliding pad. The central pivot is pre-set to insert 1 fixed I.V. pole (pag. SU 2) into the central hole (a).

Dimensions: 380x310 mm.

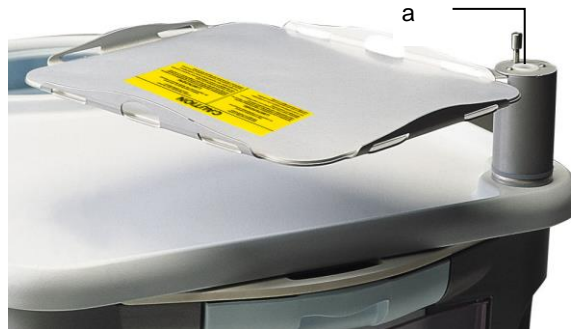

<b>CAUTION</b>	
<p>Improper Use May cause Damage To Defibrillator</p> <p>See instruction manual for operation of defibrillator swing arm</p> <p><b>LIMITATIONS:</b></p> <p>Defibrillator must fit platform: raised flanges must be external to base of defibrillator. (See Instruction Manual to match defibrillator with appropriate platform)</p> <p>Maximum load 12 kg. Do not lean on or pull Platform or Defibrillator to move trolley</p> <p>Do not put additional weight to top of defibrillator</p> <p>Transport only with platform in secure position and within external edges of trolley</p>	<p>Un Uso Improprio può Causare Danni al Defibrillatore</p> <p>Vedere manuale per le istruzioni per applicazione del defibrillatore al vassoio:</p> <p><b>LIMITAZIONI:</b></p> <p>Il defibrillatore deve essere di misura compatibile con il vassoio Posizionare il defibrillatore all'interno dei bordi del vassoio (Si veda manuale per combinare il defibrillatore al vassoio)</p> <p>Carico massimo ammesso di 12 KG Non appoggiarsi o tirare il defibrillatore per muovere il carrello</p> <p>Non aggiungere pesi supplementari sopra il defibrillatore</p> <p>Spostare il carrello con il vassoio in posizione di sicurezza posizionato internamente alla sagoma del carrello</p>

### Assembly

- 1 Remove the lid from one side of the surface.
- 2 Insert the flanged pivot into the hole.



- 3 Rotate the base of the support until the holes coincide. Screw up the shorter screw (M6 x 16) by means of the special wrencher.
- 4 Insert the stainless steel ring following the dx or sx indications (see next step).



continua

**5** Fix it with the three screws (two M6 x 20 and one M6 x 16), as shown in the following drawing:

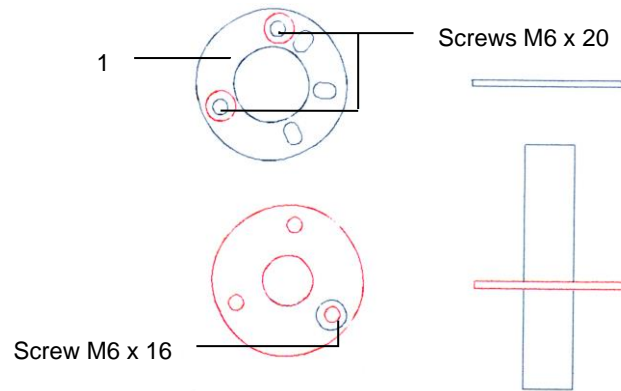

**6** Insert the tray arm onto the pivot.



## Usage

### **ATTENTION**

**Improper use of the rotating tray may cause damages to the defibrillator.**

**Make sure you do not exceed the maximum allowable loading weight of 12 kg (reported in the label that is stuck to the base of the tray surface).**

**The dimensions of the defibrillator used must be compatible with the tray.**

**Do not lean on or pull the defibrillator to move the trolley.**

**Do not lay additional weights onto the defibrillator.**

**When you move the trolley, the tray shall be moved back to the safety position – within the trolley profile**

Rotate the tray by lifting up the special knob (a) until you reach one of the three pre-set positions and then place the instrument on it.

Lay the defibrillator inside the tray borders.



## Removal

Follow the procedure described for assembly in reverse order.

## Maintenance

Refer to what is reported on pag. IN 12.

## Decommissioning and disposal

Refer to what is reported on pag. IN 14.

## Cardiac massage board

**ATTENTION:**

For a correct and safe use of the cardiac massage board with COMPACT it is necessary to read carefully the text contained in sections "INFORMATION" (from pag. IN 1) and "BODY" (from pag. BO 1) of the usage instructions.

The cardiac massage board must be placed in the special space on the body of the trolley (see lay-out on pag. SU 1).

Failure to observe the prescriptions and the procedures described in this document absolves the manufacturer of any responsibility for damages to things or people.

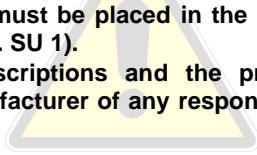

**Function** The board has the function of improving the efficiency of cardiac massages, in that it offers a rigid surface on which the back of patients can be lain.



normal assembly of the board



board and oxygen bottle holder (pag. SU 11)

**Assembly**

**1** Make the upper hole.



**2** Insert the fixing knob.



**3** From the inside of the body, insert the stop nut of the screw and tighten – while holding the screw.



**4** By means of a screwdriver, fix the small plate with the special screws



Continued

**5** Insert the board and rotate by 90° the fixing knob.



### Usage

**a** If the central oxygen bottle holder is assembled on the trolley (pag. SU 11), you just need to insert the board under the oxygen bottle holder. Otherwise follow the next steps.

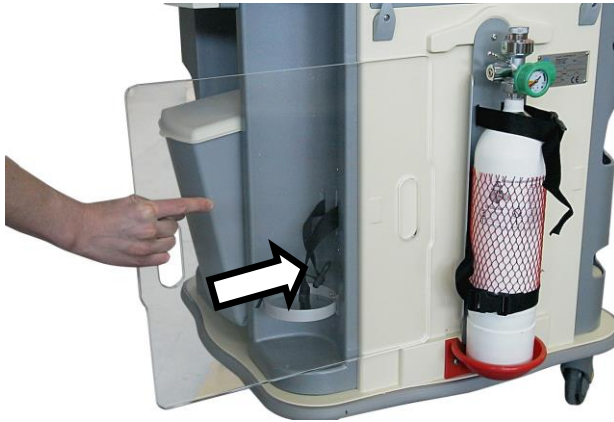

**b** Rotate by 90° the fixing knob and remove the board.



### Removal

Follow the procedure described for assembly in reverse order.

### Maintenance

Refer to what is reported on pag. IN 12.

### Decommissioning and disposal

Refer to what is reported on pag. IN 14.

## Perimetral protection

### ATTENTION:

For a correct and safe use of the perimetral protection with COMPACT it is necessary to read carefully the text contained in sections “INFORMATION” (from pag. IN 1) and “BODY” (from pag. BO 1) of the usage instructions.

This support can be installed even if the holding frame is assembled on the trolley. Failure to observe the prescriptions and the procedures described in this document absolves the manufacturer of any responsibility for damages to things or people.

### Function

This support offers a safety protection for objects that are placed on the top surface of the trolley.

### Features

The protection is made of stainless steel

### Assembly

- 1** Remove the lid (if present) from the corner of the top surface.
- 2** Align the holes of the perimetral protection flange with those of the top surface



- 3** Screw up tightly the two supplied screws with the wrencher supplied with the trolley



### Usage

Do not use this support to push or pull the trolley

### Removal

Follow the procedure described for assembly in reverse order.

### Maintenance

Refer to what is reported on pag. IN 12.

### Decommissioning and disposal

Refer to what is reported on pag. IN 14.

## Paediatric mattress

### **ATTENTION:**

For a correct and safe usage of the paediatric mattress with COMPACT it is necessary to read carefully the text contained in sections "INFORMATION" (from pag. IN 1) and "BODY" (from pag. BO 1) of the usage instructions.

Before using the paediatric mattress, the perimetral protection must be installed (pag. SU 19) if the trolley has none.

Failure to observe the prescriptions and the procedures described in this document absolves the manufacturer of any responsibility for damages to things or people.

### Function

This accessory is recommended for paediatric use; its function is that of protecting babies when they are cleaned and changed on the top surface of the trolley.

### Features

The mattress is made of soft PVC with a flexible protective edge



### Assembly

During assembly bend the three perimetral edges so as to create a protection against the borders of the perimetral protection.

### Usage

### **ATTENTION**

**Never leave the baby unattended**

**Put always some fabric between the baby and the mattress**

**Do not lay cutting objects on the mattress.**

### Removal

Follow the procedure described for assembly in reverse order.

### Maintenance

Refer to what is reported on pag. IN 12.

### Decommissioning and disposal

Refer to what is reported on a pag. IN 14.

## DEVICES (ACCESSORIES)

This section describes the devices that can be assembled on **COMPACT**.

- 1) Multiple power outlet (pag. DE 2)

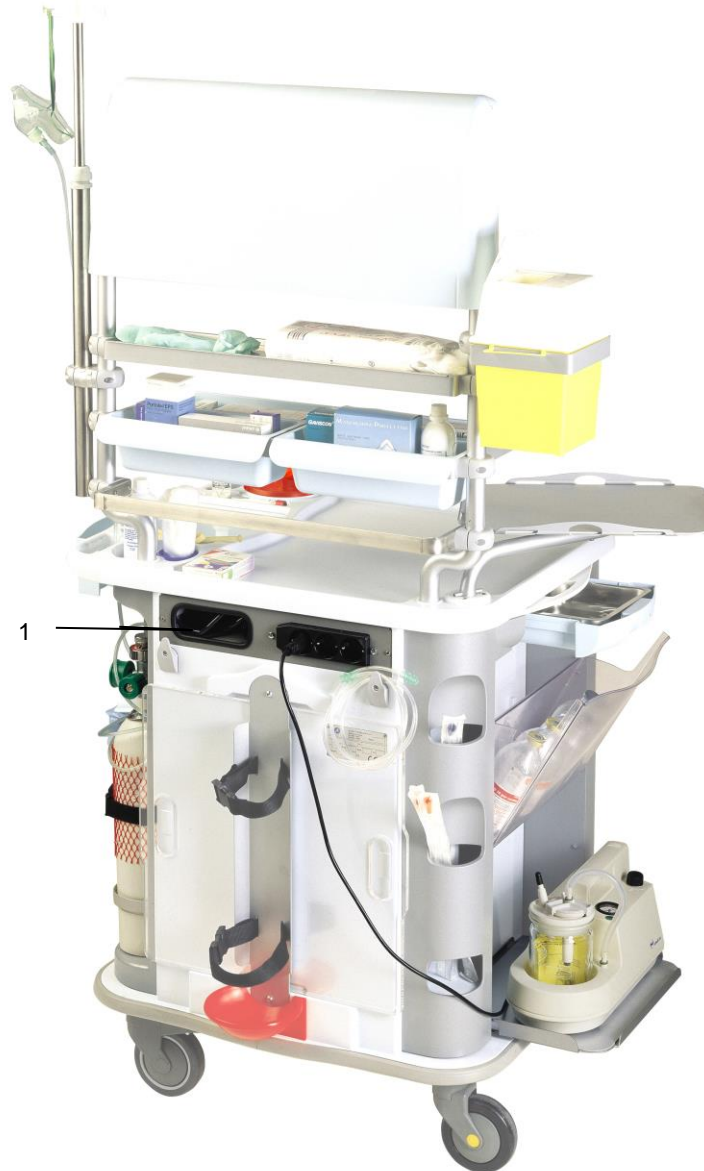



## Multiple power outlet

### ATTENTION:

For a correct and safe use of the multiple power outlet with COMPACT it is necessary to read carefully the text contained in sections "INFORMATION" (from pag. IN 1) and "BODY" (from pag. BO 1) of the usage instructions.

Failure to observe the prescriptions and the procedures described in this document absolves the manufacturer of any responsibility for damages to things or people.

Using power supply that is not recommended for this device may cause its alteration, overheating, fire, electric shock or other hazards. Use only accessories supplied or recommended by GAMMA.

There is a high death hazard if metallic objects are inserted into the power outlet slots.

Unplug the trolley before moving or cleaning it.

Do not unplug it by pulling the cable.

Do not lay or roll anything on the power supply cable.

Do not use substances containing alcohol, benzene, diluents or any other flammable substance; the use of these substances may cause fire or electric shock.

### Function

The multiple power outlet shall be used to power electrical instruments placed on the trolley.



### Features

The multiple power outlet is equipped with 3 sockets and is available only for the European market.

The features of the multiple power outlet and its declarations of conformity are enclosed with this document.

## Usage

**1** Before plugging in the trolley make sure that:

- the features reported on the yellow label correspond to the local ones (250V, 50/60 Hz);



- The electrical input of the appliances that are to be powered does not exceed 3A for each single socket (total electrical input 9A);
- Plug-in cables and stretching cables (if present) must comply with standards;
- Feeder line, outlet, distribution panel and circuit breaker must be able to interrupt short circuit power supply (CEI 64-8 appendix D);
- Phase control, section, power, length of line and grounding cables must comply with CEI EN 60204-1 standard;
- The output power supply must be grounded;
- The trolley must not be plugged in if the power supply cable or the connector are damaged (in this case the power outlet must be repaired by the technical assistance service).

**2** When the power outlet is not used, the power supply cable must be put back into its special opening.

## Removal

Remove the multiple power outlet only in case of extra-ordinary maintenance or for the disposal of the trolley.

## Maintenance

Refer to what is reported on pag. IN 12.

## Decommissioning and disposal

Refer to what is reported on pag. IN 14.