

# W-LINE WSP ADAPTER type D

(cod. ADPT\_WSP\_D – ADPT WBM\_D)

ADPT\_WSP\_D  
ADPT\_WBM\_D  
Rev 02 - 03/06/2023



## Destinazione d'uso

I supporti della line W-line sono destinati a complemento dei carrelli della medesima linea al fine di consentire la installazione di device medicali, quali Monitor Multiparametrici, Ventilatori polmonari e simili in modo da consentirne la movimentazione.

I supporti della linea W-Line sono da considerarsi accessori ai device medicali e come tali rispondono ai requisiti imposti dal Regolamento 2017/745.





E' necessario segnalare qualsiasi incidente grave verificatosi in relazione al dispositivo medico da noi fornito al fabbricante e all'autorità competente dello Stato membro in cui si ha sede.

## Intended use

The W-Line supports are intended to complement the trolleys of the same line in order to allow the installation of medical devices, such as Multiparametric Monitors, Lung Ventilators and the like in such a way as to enable their handling.

The supports of the W-Line are to be considered accessories to medical devices and as such meet the requirements of Regulation 2017/745.

You must report any serious incidents occurring in relation to the medical device we supply to the manufacturer and to the competent authority of the Member State in which you are located.

Simbolo/Symbol	Descrizione/Description
	E' obbligatorio leggere il manuale prima di mettere in funzione e utilizzare il dispositivo <i>It's mandatory to read the user manual before using the trolley</i>
	Marchio di conformità CE <i>CE conformity marking</i>
	Fabbricante <i>Manufacturer</i>
	Data di fabbricazione <i>Date of manufacture</i>
	Indica il numero di catalogo del fabbricante, in modo da poter identificare il dispositivo medico.

	<i>Indicates the manufacturer's catalogue number so that the medical device can be identified.</i>
<b>SN</b>	Indica il numero di serie del produttore, in modo da poter identificare un dispositivo medico specifico. <i>Indicates the manufacturer's serial number so that a specific medical device can be identified.</i>
<b>MD</b>	Indica che l'articolo è un dispositivo medico <i>Indicates the item is a medical device</i>
<b>UDI</b>	Indica un vettore che contiene informazioni sull'identificativo unico del dispositivo. <i>Indicates a carrier that contains Unique Device Identifier information</i>

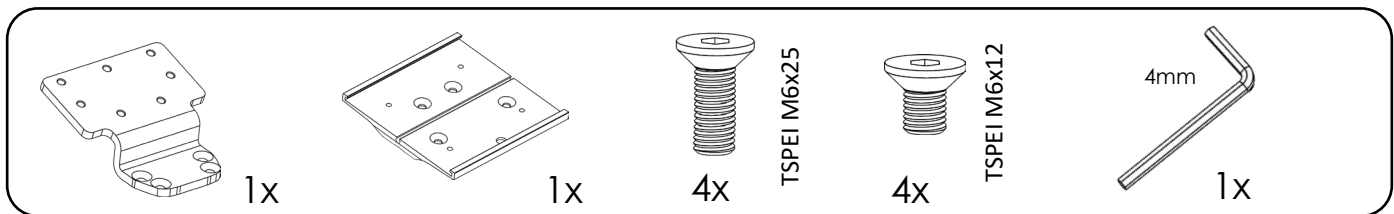
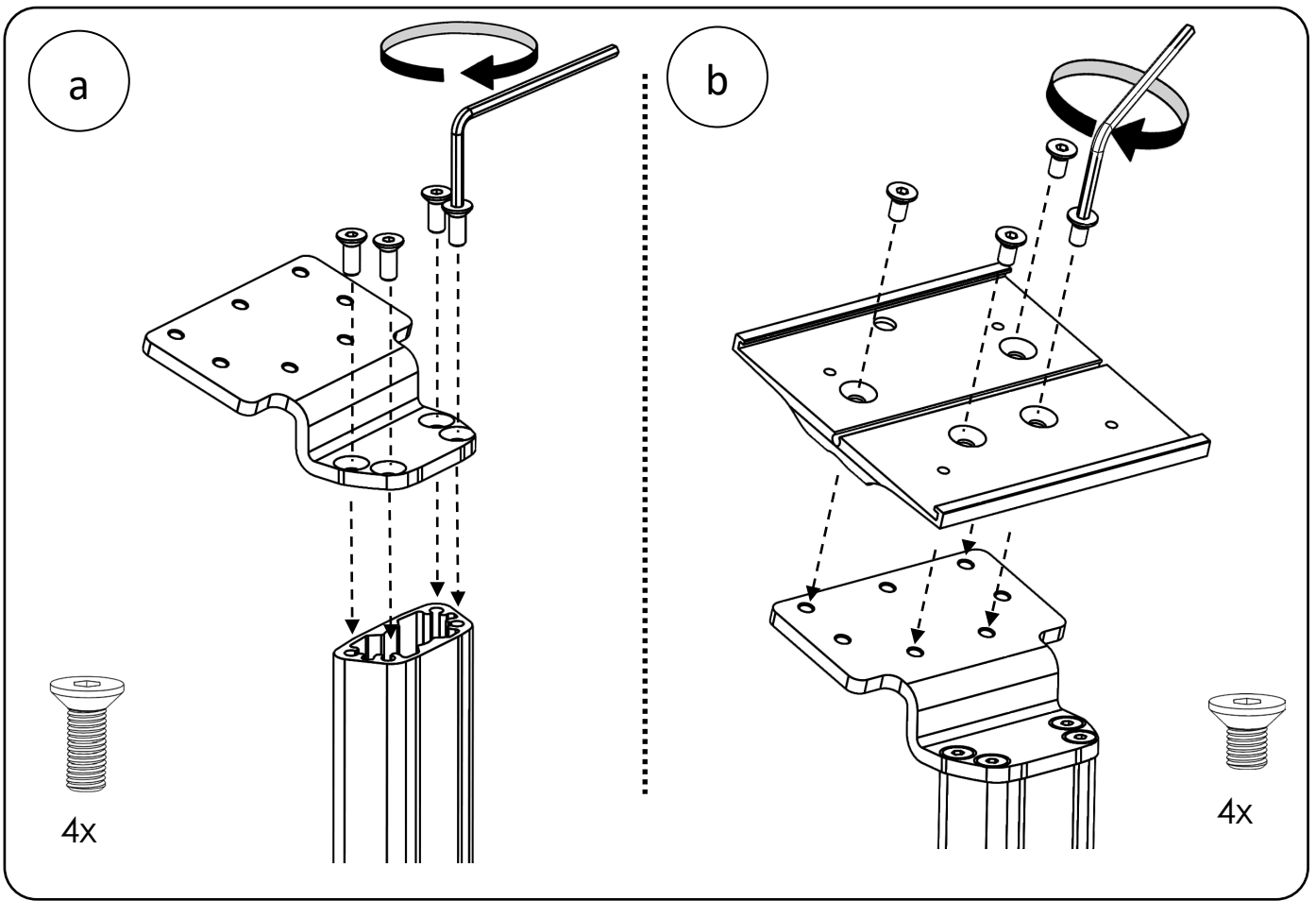

 Bieffe Italia srl  
Viale Lincoln,178  
81100 Caserta – Italy  
Email: info@weiko.com



ADPT\_WSP\_D  
ADPT\_WBM\_D