

User Manual

Breathwear Series

Sleep apnea breathing therapy mask

Full Face Mask

YF-01/YF-02/YF-03/YF-06



Suzhou Yuyue Medical Technology Co., Ltd.

No.9 Jinfeng Road., Suzhou Science & Technology
Town, 215163 Suzhou, Jiangsu, PRC
Tel: +86-512-67373001
web address: www.yuwell.com

Metrax GmbH

Rheinwaldstr.22, 78628 Rottweil, Germany
Tel: +49-741-257-0 +49-741-257-223
Fax: +49-741-257-214
E-mail: vigilance@primedic.com
heiko.borkowsky@primedic.com



Prepared date: 2025-02

IFU-V-141

version: A/4

English

CONTENTS

Use Guide	1
Intended Use	1
Contraindications	1
Cleaning the Mask	3
Troubleshooting	5
Storage	5
Disposal	5
Symbols	5
Limited Warranty	6
Notice	6
Part I Full Face Mask YF-01	7
Mask composition	7
Use mask	7
Technical Specifications	10
Part II Full Face Mask YF-02	12
Mask composition	12
Use mask	12
Technical Specifications	15
Part III Full Face Mask YF-03	16
Mask composition	16
Use mask	16
Technical Specifications	19
Part IV Full Face Mask YF-06	20
Mask composition	20
Use mask	20
Technical Specifications	23

Thank you for choosing Yuyue's Sleep apnea breathing therapy mask (hereafter referred to as mask). This User Manual provides instructions for use of Full face masks, including models of YF-01/YF-02/YF-03/YF-06.

Use Guide

Read the complete User manual before use.

Please refer to each Part on how to use the mask.

- Refer to Part I for instructions of the Full Face Mask YF-01
- Refer to Part II for instructions of the Full Face Mask YF-02
- Refer to Part III for instructions of the Full Face Mask YF-03
- Refer to Part V for instructions of the Full Face Mask YF-06

Intended Use

The mask is a noninvasive accessory used for channeling airflow (With or without supplemental oxygen) to a patient from a positive airway pressure (PAP) device such as a continuous positive airway pressure (CPAP) or bi-level system.

- The mask is to be used by adult patients (weighing >30kg), intended for single patient reuse in the home environment.
- The mask is intended for single-patient use in the hospital or institutional environment.

Contraindications

If the user has the following diseases, the product may not be suitable for use. Special attention should also be given when it must be used. In either case, it is up to the doctor to decide whether or not to use the mask. These diseases include:

- Recent eye surgery or dry eyes
- Glaucoma
- Hiatal hernia
- Impaired cardiac sphincter function, excessive reflux, impaired cough reflex
- Vomiting
- Bullous Lung Disease
- Pathologically Low Blood Pressure
- Bypassed Upper Airway

- Pneumothorax
- Diagnosed with acute sinusitis or otitis media
- At risk for aspiration of gastric contents
- Allergy or hypersensitivity to the mask materials, or on patients unable to remove the mask

 **CAUTION:**

In the US, Federal law restricts the sale of this device to sale by or on the order of a physician.

 **WARNINGS:**

- Please read the entire guide before use.
- The vent holes must be kept clear. Do not cover, block, or close the vent holes on the mask when in use.
- CPAP systems are intended to be used with special masks with connectors which have vent holes to allow continuous flow of air out of the mask. When the CPAP machine is turned on and functioning properly, new air from the CPAP machine flushes the exhaled air out through the attached mask exhalation port. However, when the CPAP machine is not operating, enough fresh air will not be provided through the mask, and exhaled air will be rebreathed. Rebreathing of exhaled air for longer than several minutes can, in some circumstances, lead to suffocation. This warning applies to most models of CPAP systems.
- At low CPAP pressures the flow through the exhaled port may be inadequate to clear all exhaled gas from the tube. Some rebreathing may occur.
- To minimize the risk of vomiting during sleep, the patient should avoid eating or drinking for three hours before using the mask. This mask is not recommended if the patient is taking a prescription drug that may cause vomiting.
- Do not use the mask without the Anti-Asphyxia Valve in place.
- This mask should not be used on patients who are uncooperative, obtunded, unresponsive, or unable to remove the mask.
- Follow all precautions when using supplemental oxygen.
- Oxygen flow must be turned off when the flow generator is not operating, so that unused oxygen does not accumulate within the flow generator enclosure and create a risk of fire.
- Anyone wearing this mask for oxygen use needs to stay away from sources of ignition (e.g. smoking).
- At a fixed flow rate of supplemental oxygen flow, the inhaled oxygen

concentration varies, depending on the pressure settings, patient breathing pattern, mask, point of application and leak rate.

- The technical specifications of the mask are provided for your clinician to check if it is compatible with the flow generator. If it is used beyond technical specifications or used with incompatible devices, the seal and comfort of the mask may not be effective, optimum therapy may not be achieved, and leak, or variation in the rate of leak, may affect the function of the flow generator.
- Stop using the mask and consult your physician or sleep therapist, if you have ANY adverse reaction(e.g. Nausea, vomiting, skin redness, irritation or discomfort) to the use of the mask.
- Use of the mask may cause pain in the teeth, gums or jaw or aggravate existing dental conditions. If a condition develops, stop using and consult your physician.
- Refer to your flow generator manual for details on settings and operational information.
- As with all masks, some rebreathing may occur at low CPAP pressures.
- Remove all packaging before using the mask.
- Discontinue use if discomfort or irritation occurs, and consult your healthcare provider.

Cleaning the Mask

➤ **Cleaning the Mask at Home**

Notes:

- The mask and headgear can only be cleaned through hand washing.
- The elbow and the valve cannot be disassembled for washing.
- If any visible deterioration of a mask component is apparent (cracking, crazing, tears etc), the mask component should be discarded and replaced.
- Recommended replacement masks after cleaning 380 times. It is recommended that the mask be replaced at least once a year.

WARNINGS

- Do not use solutions containing bleach, chlorine, alcohol, aromatics, moisturizers, antibacterial agents, or scented oils to clean any part of the system or air tubing. These solutions may cause damage and reduce the life of the product.
- Do not use dishwasher to wash this mask.

- Do not dry the mask components in direct sunlight as it may accelerate product aging.
- Do not iron the headgear. It may damage the headgear.
- Frequency of cleaning, methods of cleaning or the use of cleaning agents, other than those specified in the following instructions can have an adverse effect on the mask components and consequently the safety or the quality of the therapy.

Daily / After Each Use:

- Disassemble the mask components according to the disassembly instructions.
- Thoroughly clean the separated mask components (excluding headgear), by gently rubbing in warm (approx. 30°C) water using mild soap. Soak in water no more than 10 minutes.
- Use a soft bristle brush to clean the vent.
- To optimise the mask seal, facial oils should be removed from the cushion after use.
- Inspect each component and, if required, repeat washing until visually clean, making sure there is no soap residue.
- Rinse all components well 3-5min with drinking quality water and allow to air dry out of direct sunlight.
- When all components are dry, reassemble according to the reassembly instructions.

Weekly:

- Hand washes the headgear and all components in warm (approx. 30°C) and soapy water. Use pure soap. Rinse the components well and allow them to air dry out of direct sunlight.
- This action will age or damage the mask and shorten its service life. If any visible deterioration of a mask component is apparent (cracking, crazing, tears etc), the mask component should be discarded and replaced.

➤ Use the Mask in the Hospital or Institutional environment

CAUTIONS

The mask is for single-patient use in the hospital or institutional environment. Please reprocess the mask according to “**Cleaning & Disinfection Instructions**”.

Troubleshooting

Problem	Possible cause	Solution
Mask is too noisy	Vents are blocked or partially blocked. Mask is assembled incorrectly.	Clean vents according to Instructions in “Cleaning the Mask at Home”. Reassemble mask.
Mask leaks around the face.	Mask may have been fitted incorrectly.	Carefully follow instructions in “Fitting”.
Mask is uncomfortable	Mask may have been fitted incorrectly.	Carefully follow instructions in “Fitting”.
	Mask cushion may be dirty	Clean vents according to Instructions in “Cleaning the Mask at Home”.

Storage







Ensure that the mask is thoroughly clean and dry before storing it for any length of time. Store the mask in a dry place out of direct sunlight.







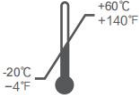



Disposal

The mask does not contain any hazardous substances and may be disposed of with your normal household refuse.

Symbols

System and Packaging

	Batch code
	Date of manufacture
	Catalog number
	Not made with natural rubber latex
	Temperature limitation
	Humidity limitation

	Manufacturer
	Authorized Representative in the European Community
	Medical Device
	Use-by date
	Consult instructions for use
	Single Patient - multiple use
	Caution, consult accompanying documents. Indicates a Warning or Caution and alerts you to a possible injury or explains special measures for the safe and effective use of the device.
	CE Mark
	Unique device identifier
	Keep away from sunlight

Limited Warranty

It is warranted that the Mask, including Frame assembly, Cushion, Headgear shall be free from defects in material and workmanship for a period of ninety (90) days from the date of purchase by the initial consumer.

This warranty does not cover damage caused by accident, misuse, abuse, negligence, alteration, failure to use or maintain the Product under conditions of normal use and in accordance with the terms of the product literature, and other defects not related to materials or workmanship.

Notice

For any serious incident that has occurred in relation to the device, please contact **Suzhou Yuyue Medical Technology Co., Ltd.**, or the competent authority of the Member State in which the user or patient is established.

Part I Full Face Mask YF-01

Mask composition

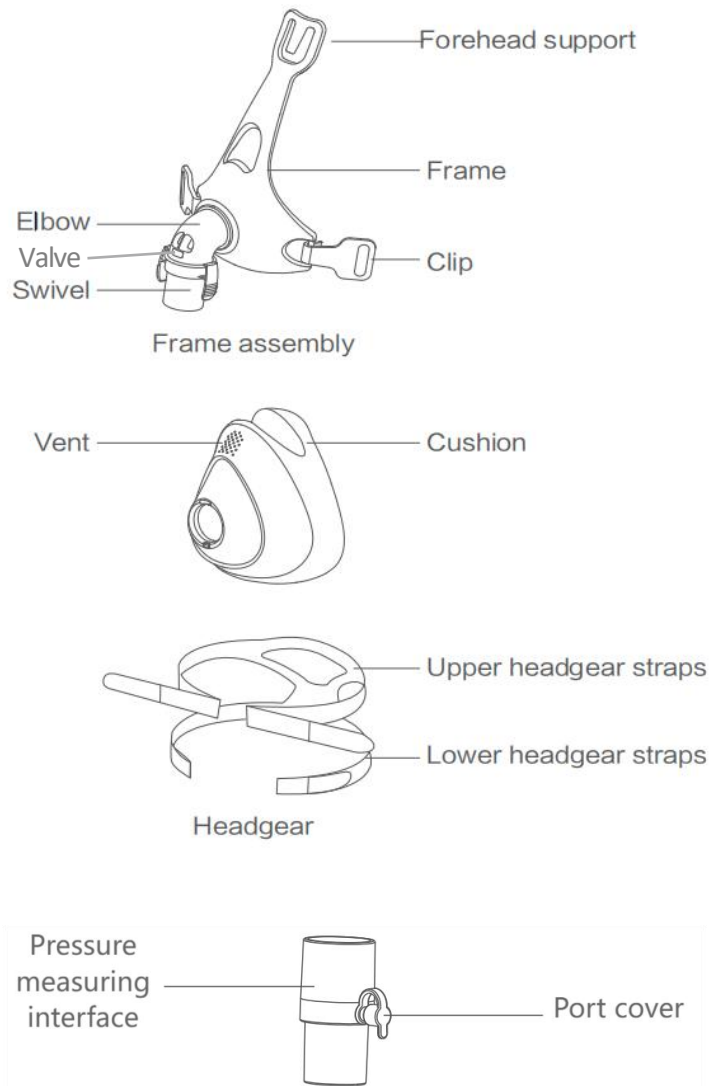

Use mask

➤ Fitting

Use the Pressure measuring interface if pressure readings and / or supplemental oxygen are required.

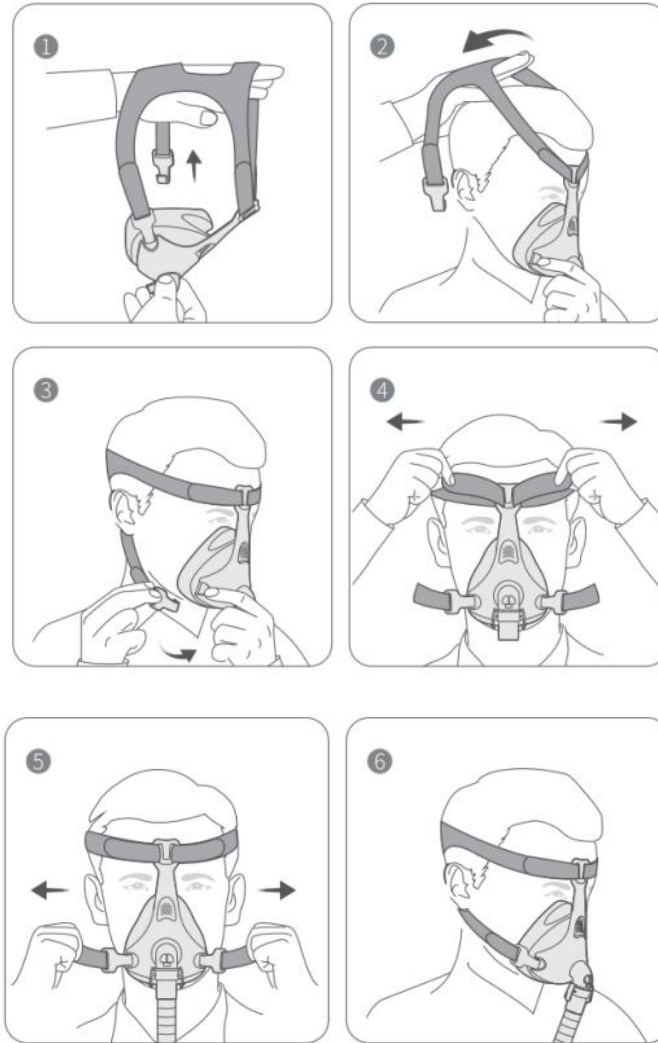

1. Unclip one of the lower headgear clips from the frame.
2. Hold the mask steadily on your face and pull the headgear over your head.
3. Bringing the lower headgear straps below your ears, clip the headgear to the lower part of the frame.
4. Undo the fastening tabs on the upper headgear straps. Pull the straps evenly until they are comfortable and firm, and reattach the Velcro. Ensure that the mask fits well.
5. Undo the fastening tabs on the lower headgear straps. Pull the straps evenly until the mask is stable and comfortable. Reattach the fastening tabs. Connect the breathing tube to the swivel of the mask.
6. Start the flow generator and make sure the mask fits properly and there are no air leaks; if there are air leaks, readjust the headgear and mask. Your mask and headgear should be positioned as shown in the illustration.

 **Note:**

- Do not over-tighten any of the headgear straps.
- Connect the breathing tube to the swivel of mask and ensure it is firmly connected.

➤ **Removal**

To remove the mask, disconnect one of the lower headgear clips and pull the mask and headgear up over your head.

 **CAUTIONS:**

- Do not remove the headgear until the clips is released
- Please confirm that you can remove the buckle and headgear freely

➤ **Disassembly**

 **Notes:**

The elbow can may be incurred and the re-installation will become more difficult.

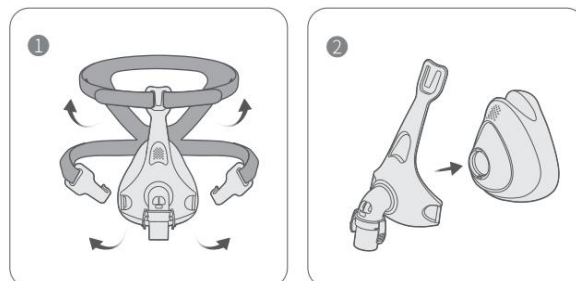

1. Detach the breathing tube. Unclip the lower headgear clips and unhook the upper headgear Straps.
2. Gently separate the cushion from the frame.

➤ **Reassembly**

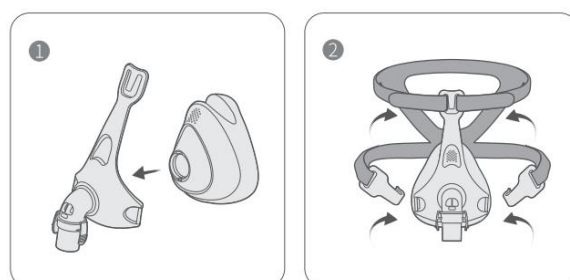

1. Fit the cushion into the channel of the frame.
2. Threading the upper headgear straps through the loop of the frame. Keep the clips attached to the lower headgear straps and clip the headgear to the lower part of the frame.

Technical Specifications

Pressure-Flow Curve

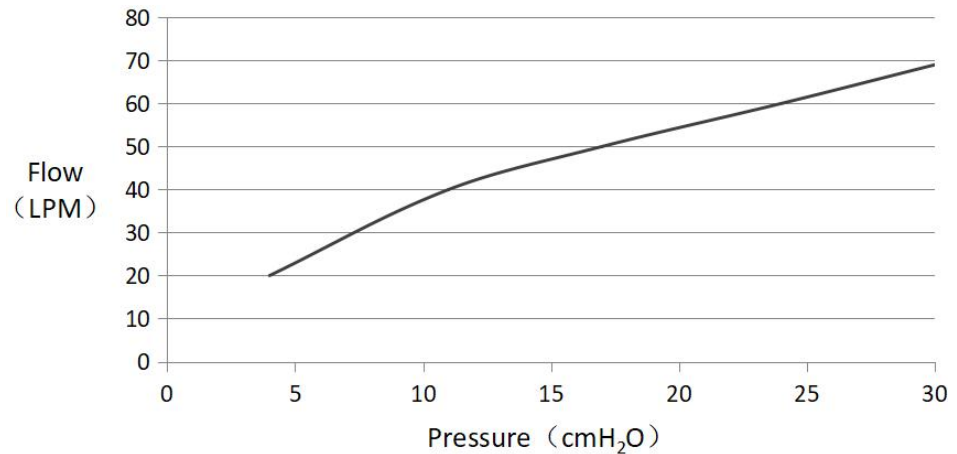

Therapy Pressure	4-30cmH ₂ O
Resistance	Drop in Pressure measured at 50 L/min: ≤ 0.5 cmH ₂ O at 100 L/min: ≤ 1.5 cmH ₂ O
Inspiratory and expiratory resistance with the Anti-Asphyxia Valve open-to-atmosphere pressure	Inspiratory at 50 L/min: ≤ 2 cmH ₂ O Expiratory at 50 L/min: ≤ 2 cmH ₂ O
The Anti-Asphyxia Valve open-to-atmosphere pressure	≤ 2 cmH ₂ O
The Anti-Asphyxia Valve closed-to-atmosphere pressure	≤ 2 cmH ₂ O
Sound	DECLARED DUAL-NUMBER NOISE EMISSION VALUES in accordance with ISO 4871. The A-weighted sound power level of the mask is less than 33dBA, with uncertainty 3dBA. The A-weighted sound pressure level of the mask at a distance of 1 m is less than 25dBA, with uncertainty 3dBA.

Environmental Conditions	Operating temperature: +5°C to+ 40°C (41°F to 104°F) Operating humidity: 10%~90% relative humidity non-condensing Storage and transport: -20°C to +60°C (-4°F to 140°F) Storage and transport humidity: 10%~90% relative humidity non-condensing
--------------------------	---

Note: The mask system does not contain natural rubber latex, PVC or DEHP materials.

Part II Full Face Mask YF-02

Mask composition

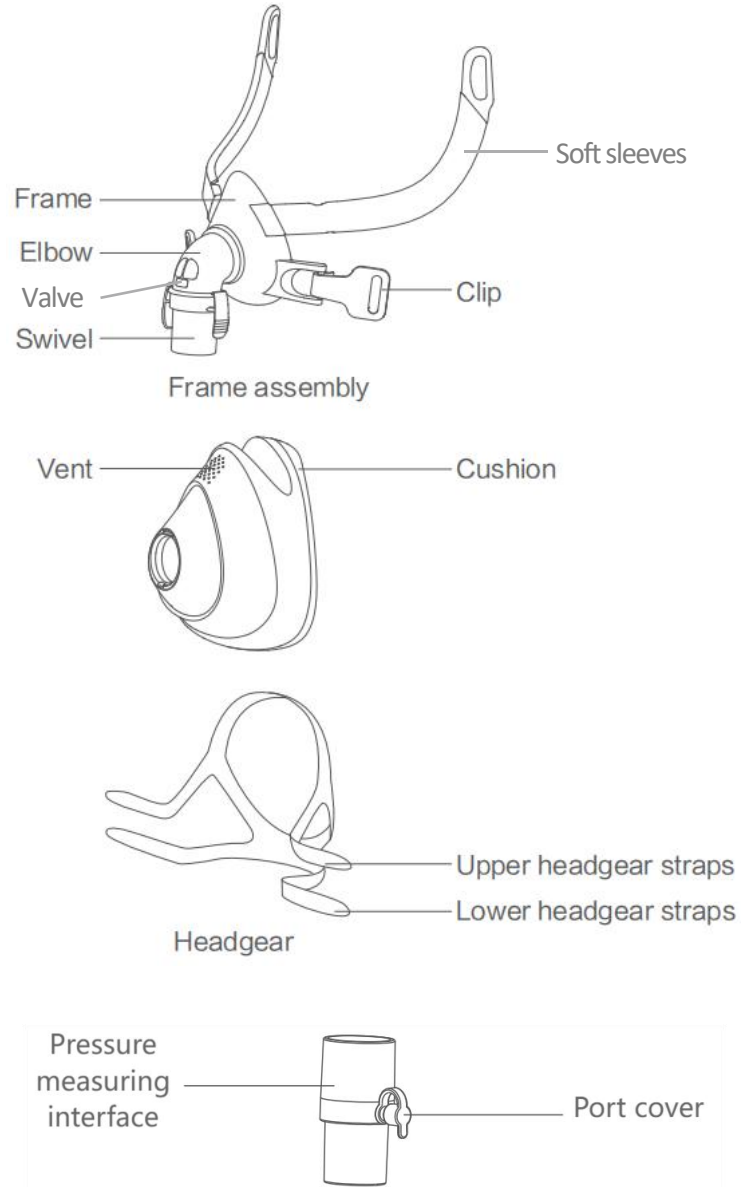

Use mask

➤ Fitting

Use a Pressure measuring interface if pressure readings and / or supplemental oxygen are required.

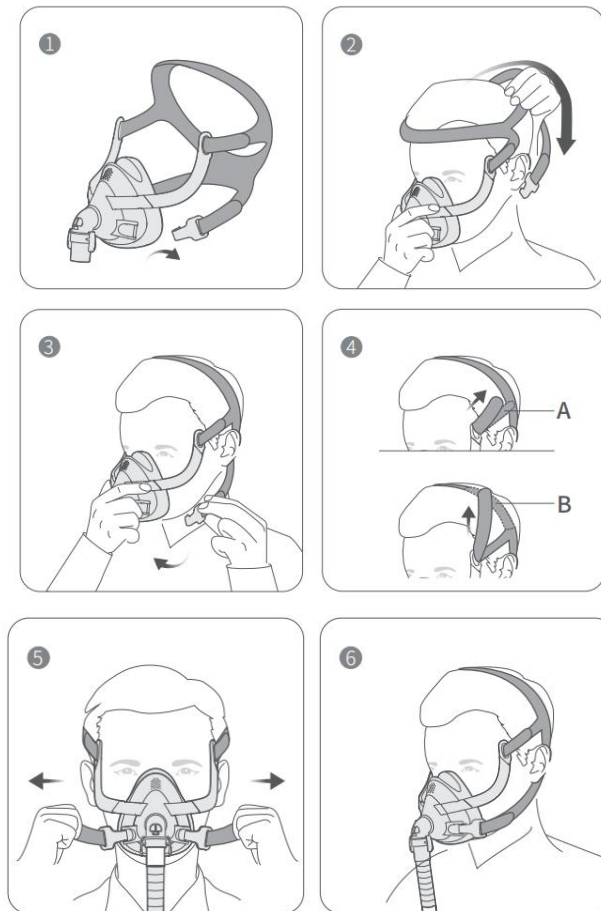

1. Unclip one of the lower headgear clips from the frame.
2. Hold the mask steadily on your face and pull the headgear over your head.
3. Bringing the lower headgear straps below your ears, clip the headgear to the lower part of the frame.
4. Undo the fastening tabs on the upper headgear straps. Pull the straps evenly towards the top of head or above ears until the mask is stable and comfortable. Reattach the fastening tabs.
5. Undo the fastening tabs on the lower headgear straps. Pull the straps evenly until the mask is stable and comfortable. Reattach the fastening tabs. Connect the breathing tube to the swivel of the mask.
6. Start the flow generator and make sure the mask fits properly and there are no air leaks; if there are air leaks, readjust the headgear and mask. Your mask and headgear should be positioned as shown in the illustration.

⚠ Note:

- Do not over-tighten any of the headgear straps.
- Connect the breathing tube to the swivel of mask and ensure it is firmly connected.

➤ Removal

To remove the mask, disconnect one of the lower headgear clips and pull the mask and headgear up over your head.

⚠ CAUTIONS:

- Do not remove the headgear until the clips is released
- Please confirm that you can remove the buckle and headgear freely

➤ Disassembly

⚠ Notes:

The elbow can may be incurred and the re-installation will become more difficult.

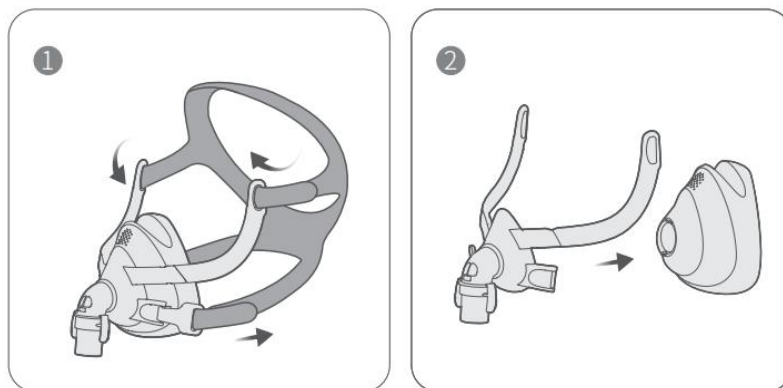

1. Detach the breathing tube. Unclip the lower headgear clips and unhook the upper headgear Straps.

2. Gently separate the cushion from the frame.

➤ Reassembly

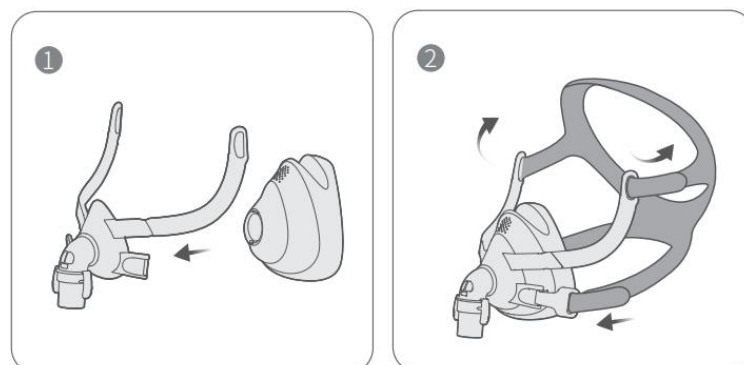

1. Fit the cushion into the channel of the frame.

2. Threading the upper headgear straps through the loop of the frame. Keep the clips attached to the lower headgear straps and clip the headgear to the lower part of the frame.

Technical Specifications

Pressure-Flow Curve

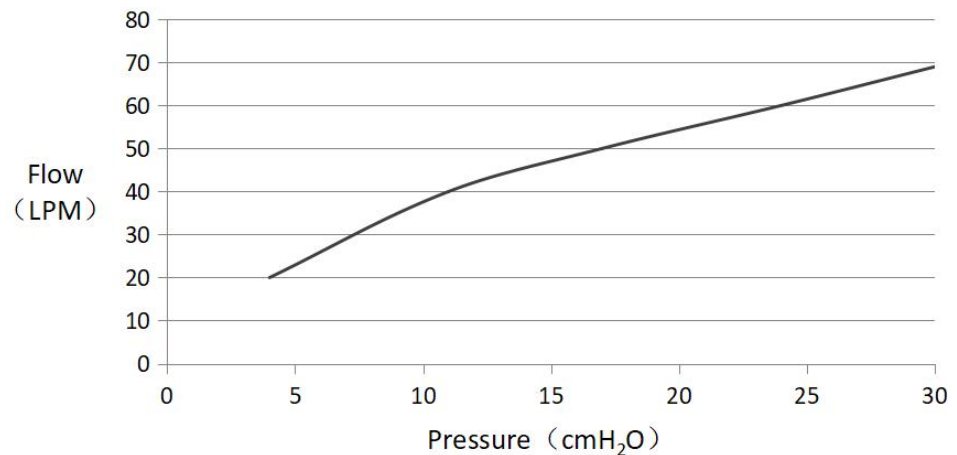

Therapy Pressure	4-30cmH ₂ O
Resistance	Drop in Pressure measured at 50 L/min: ≤ 0.5 cmH ₂ O at 100 L/min: ≤ 1.5 cmH ₂ O
Inspiratory and expiratory resistance with the Anti-Asphyxia Valve open-to-atmosphere pressure	Inspiratory at 50 L/min: ≤ 2 cmH ₂ O Expiratory at 50 L/min: ≤ 2 cmH ₂ O
The Anti-Asphyxia Valve open-to-atmosphere pressure	≤ 2 cmH ₂ O
The Anti-Asphyxia Valve closed-to-atmosphere pressure	≤ 2 cmH ₂ O
Sound	DECLARED DUAL-NUMBER NOISE EMISSION VALUES in accordance with ISO 4871. The A-weighted sound power level of the mask is less than 33dBA, with uncertainty 3dBA. The A-weighted sound pressure level of the mask at a distance of 1 m is less than 25dBA, with uncertainty 3dBA.
Environmental Conditions	Operating temperature: +5°C to+ 40°C (41°F to 104°F) Operating humidity: 10%~90% relative humidity non-condensing Storage and transport: -20°C to +60°C (-4°F to 140°F) Storage and transport humidity: 10%~90% relative humidity non-condensing

Note: The mask system does not contain natural rubber latex, PVC or DEHP materials.

Part III Full Face Mask YF-03

Mask composition

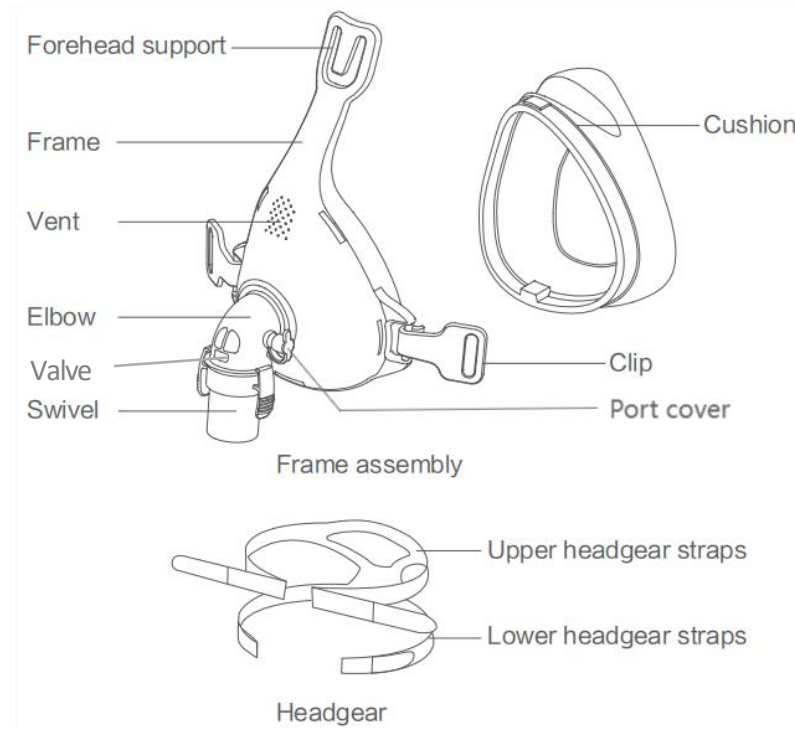

Use mask

➤ Fitting

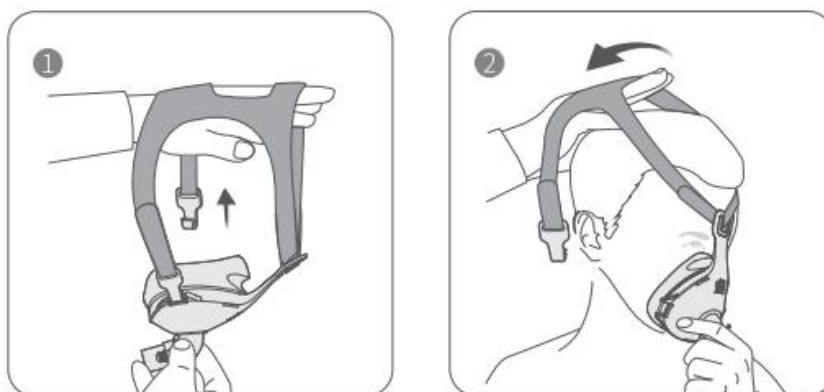

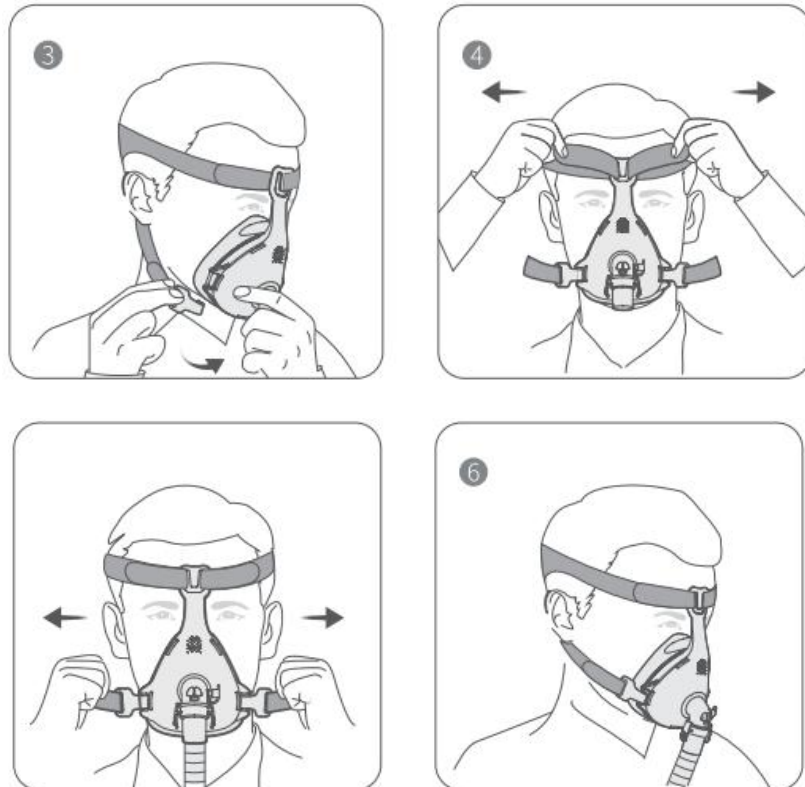

1. Unclip one of the lower headgear clips from the frame.
2. Hold the mask steadily on your face and pull the headgear over your head.
3. Bringing the lower headgear straps below your ears, clip the headgear to the lower part of the frame.
4. Undo the fastening tabs on the upper headgear straps. Pull the straps evenly until they are comfortable and firm, and reattach the Velcro. Ensure that the mask fits well.
5. Undo the fastening tabs on the lower headgear straps. Pull the straps evenly until the mask is stable and comfortable. Reattach the fastening tabs. Connect the breathing tube to the swivel of the mask.
6. Start the flow generator and make sure the mask fits properly and there are no air leaks; if there are air leaks, readjust the headgear and mask. Your mask and headgear should be positioned as shown in the illustration.

 **Note:**

- Do not over-tighten any of the headgear straps.
- Connect the breathing tube to the swivel of mask and ensure it is firmly connected.

➤ Removal

To remove the mask, disconnect one of the lower headgear clips and pull the mask and headgear up over your head.

⚠ **CAUTIONS:**

- Do not remove the headgear until the clips is released
- Please confirm that you can remove the buckle and headgear freely

➤ Disassembly

⚠ **Notes:**

The elbow can may be incurred and the re-installation will become more difficult.

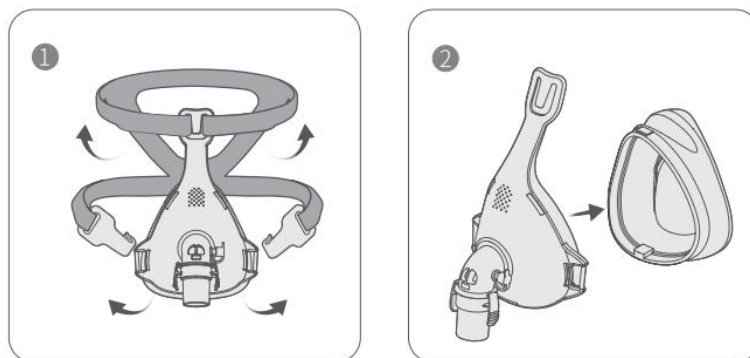

1. Detach the breathing tube. Unclip the lower headgear clips and unhook the upper headgear Straps.
2. Gently separate the cushion from the frame.

➤ Reassembly

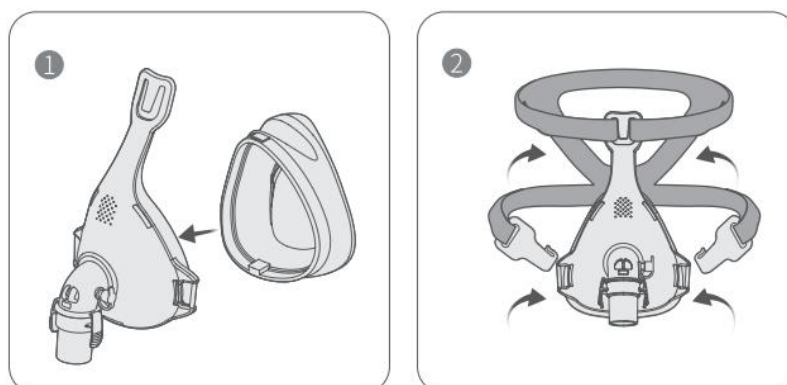

1. Fit the cushion into the channel of the frame.

2. Threading the upper headgear straps through the loop of the frame. Keep the clips attached to the lower headgear straps and clip the headgear to the lower part of the frame.

Technical Specifications

Pressure-Flow Curve

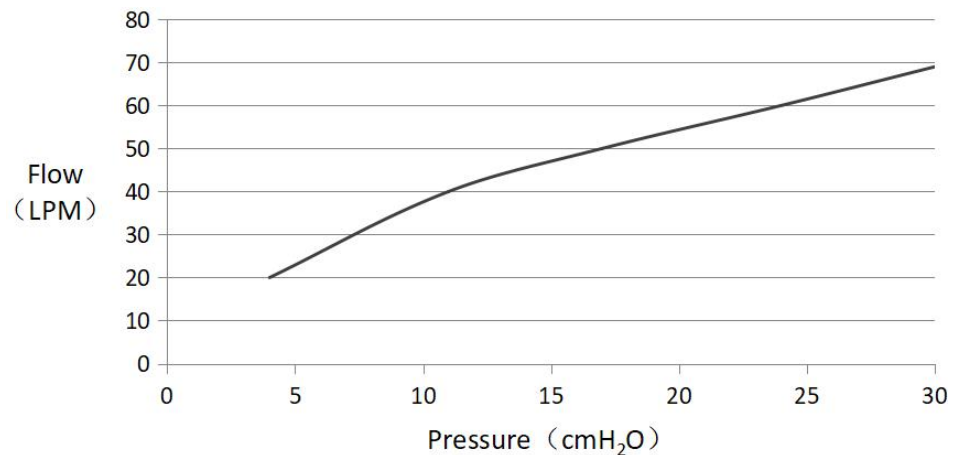

Therapy Pressure	4-30cmH ₂ O
Resistance	Drop in Pressure measured at 50 L/min: ≤ 0.5 cmH ₂ O at 100 L/min: ≤ 1.5 cmH ₂ O
Inspiratory and expiratory resistance with the Anti-Asphyxia Valve open-to-atmosphere pressure	Inspiratory at 50 L/min: ≤ 2 cmH ₂ O Expiratory at 50 L/min: ≤ 2 cmH ₂ O
The Anti-Asphyxia Valve open-to-atmosphere pressure	≤ 2 cmH ₂ O
The Anti-Asphyxia Valve closed-to-atmosphere pressure	≤ 2 cmH ₂ O
Sound	DECLARED DUAL-NUMBER NOISE EMISSION VALUES in accordance with ISO 4871. The A-weighted sound power level of the mask is less than 33dBA, with uncertainty 3dBA. The A-weighted sound pressure level of the mask at a distance of 1 m is less than 25dBA, with uncertainty 3dBA.
Environmental Conditions	Operating temperature: +5°C to+ 40°C (41°F to 104°F) Operating humidity: 10%~90% relative humidity non-condensing Storage and transport: -20°C to +60°C (-4°F to 140°F) Storage and transport humidity: 10%~90% relative humidity non-condensing

Note: The mask system does not contain natural rubber latex, PVC or DEHP materials.

Part IV Full Face Mask YF-06

Mask composition

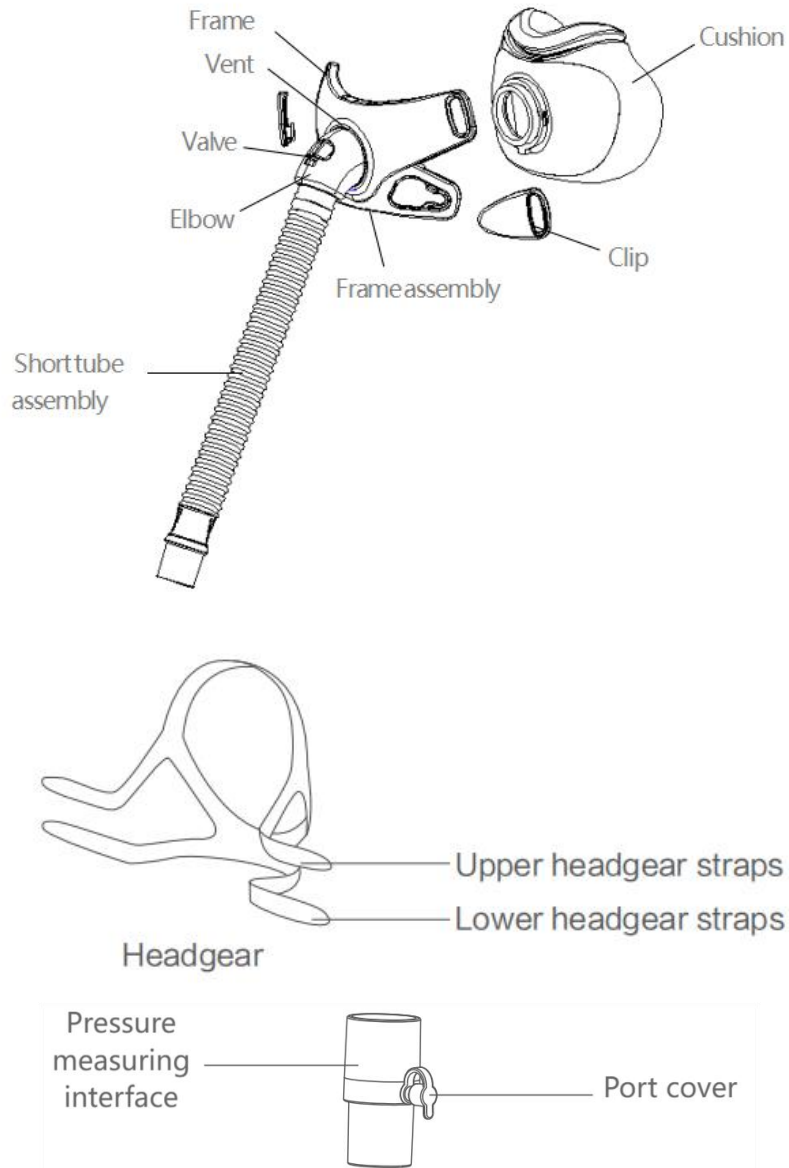

Use mask

➤ Fitting

Use the Pressure measuring interface if pressure readings and / or supplemental oxygen are required.

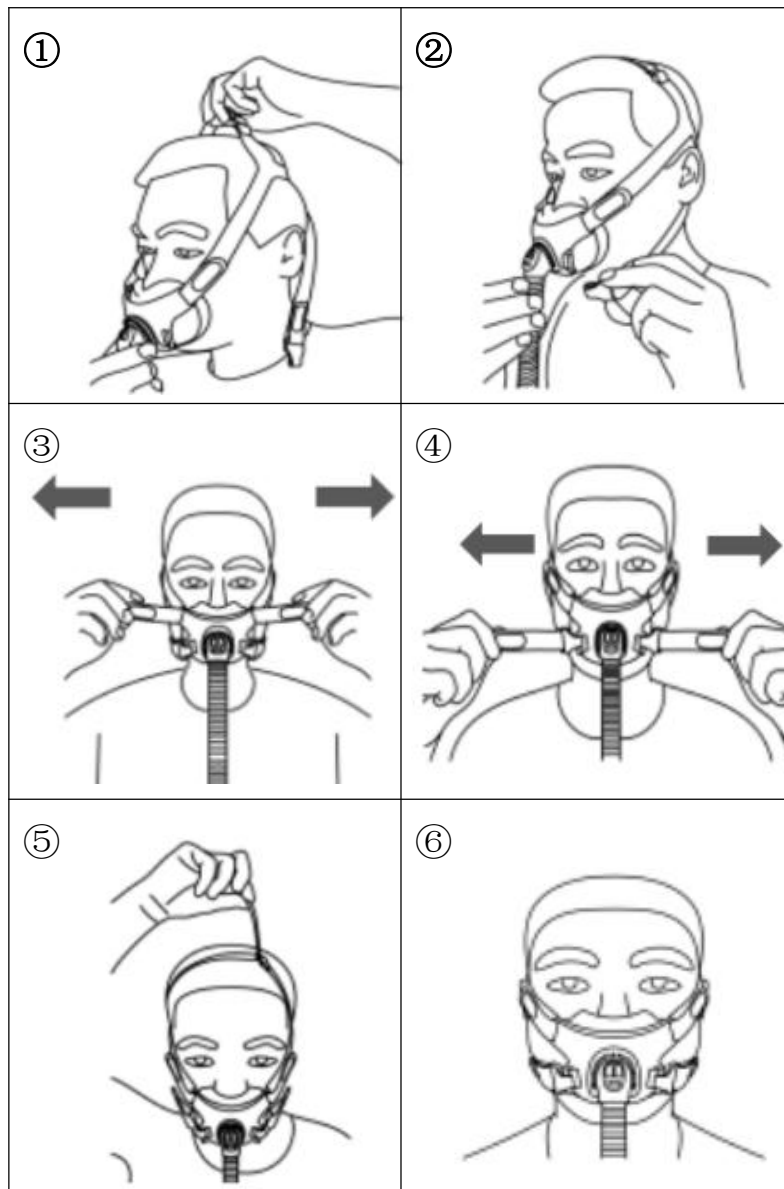

1. Hold the mask steadily on your face and pull the headgear over your head.
2. Bringing the lower headgear straps below your ears, clip the headgear to the lower part of the frame.
3. Undo the fastening tabs on the upper headgear straps. Pull the straps evenly until they are comfortable and firm, and reattach the Velcro. Ensure that the mask fits well.
4. Undo the fastening tabs on the lower headgear straps. Pull the straps evenly until the mask is stable and comfortable. Reattach the fastening tabs.
5. Undo the fastening tabs on the top headgear straps. Pull the straps evenly until the mask is stable and comfortable. Connect the breathing tube to the swivel of the mask.
6. Start the flow generator and make sure the mask fits properly and there are no air

leaks; if there are air leaks, readjust the headgear and mask. Your mask and headgear should be positioned as shown in the illustration.

 **Note:**

- Do not over-tighten any of the headgear straps.
- Connect the breathing tube to the swivel of mask and ensure it is firmly connected.

➤ **Removal**

To remove the mask, disconnect one of the lower headgear clips and pull the mask and headgear up over your head.

 **CAUTIONS:**

- Do not remove the headgear until the clips is released
- Please confirm that you can remove the buckle and headgear freely

➤ **Disassembly**

 **Notes:**

The elbow can may be incurred and the re-installation will become more difficult.

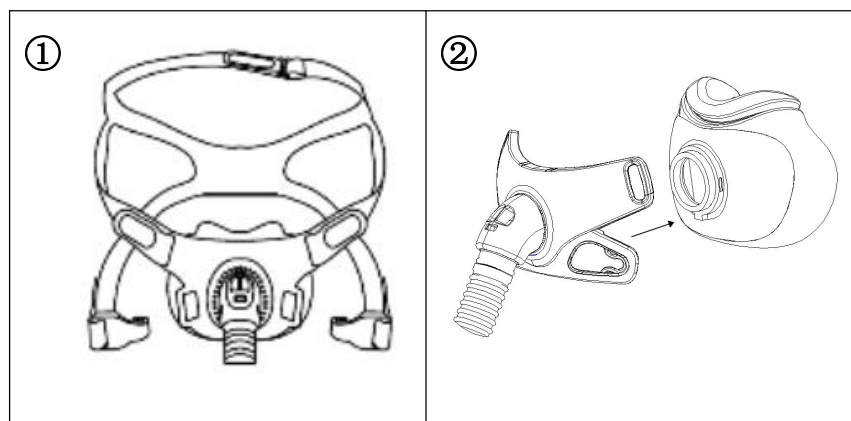

1. Detach the breathing tube. Unclip the lower headgear clips and unhook the upper headgear Straps.
2. Gently separate the cushion from the frame.

➤ **Reassembly**

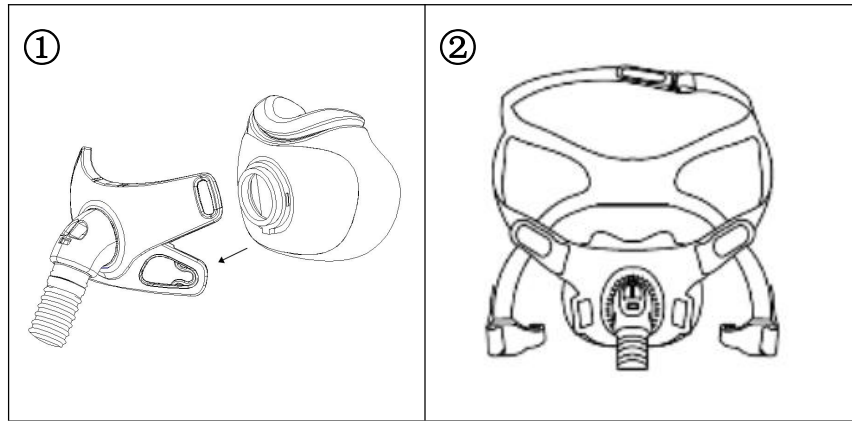

1. Fit the cushion into the channel of the frame.
2. Threading the upper headgear straps through the loop of the frame. Keep the clips attached to the lower headgear straps and clip the headgear to the lower part of the frame.

Technical Specifications

Pressure-Flow Curve

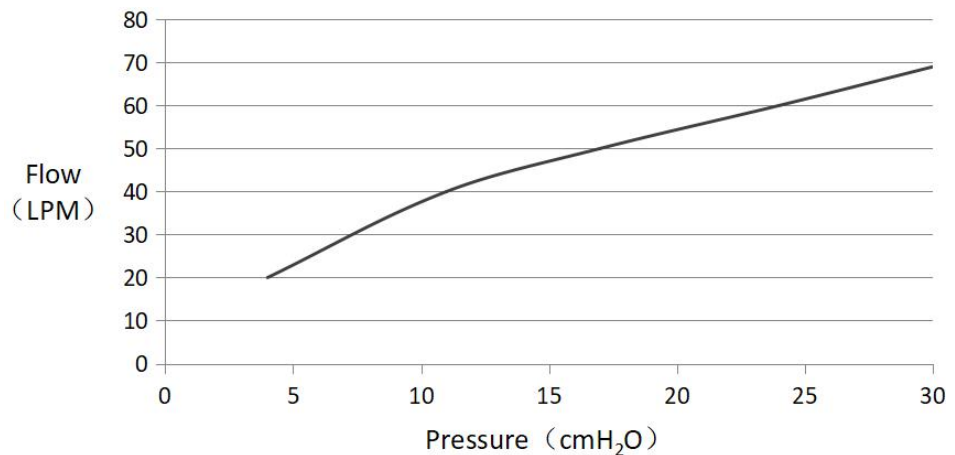

Therapy Pressure	4-30cmH ₂ O
Resistance	Drop in Pressure measured at 50 L/min: ≤ 0.5 cmH ₂ O at 100 L/min: ≤ 1.5 cmH ₂ O
Inspiratory and expiratory resistance with the Non-Rebreathing Valve open-to-atmosphere pressure	Inspiratory at 50 L/min: ≤ 2 cmH ₂ O Expiratory at 50 L/min: ≤ 2 cmH ₂ O
The Non-Rebreathing Valve open-to-atmosphere pressure	≤ 2 cmH ₂ O
The Non-Rebreathing	≤ 2 cmH ₂ O

Valve
closed-to-atmosphere
pressure

Sound

DECLARED DUAL-NUMBER NOISE EMISSION VALUES in accordance with ISO 4871. The A-weighted sound power level of the mask is less than 33dBA, with uncertainty 3dBA. The A-weighted sound pressure level of the mask at a distance of 1 m is less than 25dBA, with uncertainty 3dBA.

Environmental Conditions

Operating temperature: +5°C to+ 40°C (41°F to 104°F)
Operating humidity: 10%~90% relative humidity
non-condensing
Storage and transport: -20°C to +60°C (-4°F to 140°F)
Storage and transport humidity: 10%~90% relative humidity
non-condensing

Note: The mask system does not contain natural rubber latex, PVC or DEHP materials.